



ECev

User manual

Document change log	3
Introduction	4
ECweb	5
Connecting to ECweb with Internet Explorer or Pale Moon browser on PC/laptop	5
Connecting to ECweb using any other browser or mobile device	6
Troubleshooting	6
Navigating the ECweb	8
Control	10
IP configuration	10
Internal clock	10
NTP synchronization	10
Manual time adjustment	11
ECev server access	12
ECev Telnet server	12
ECev web server (ECweb)	13
Identifiers	14
ECev information	14
Project details	14
Password scheme	15
Passwords	16
Permissions	17
License & Extras	18
Search online	18
Backups	18
Application	20
Settings	21
RS485 COM ports	21
Alarms	22
Master Alarms	23
COM2 slave	23
COM3 slave	24
TCP slave	24
Common master communication	25
IO modules	26
Analogue input/output	27
EV Charging stations	28
Settings	28
Ratings	29
Guns/charging points	29
Counters	30

Communication settings	31
RTU	31
TCP	32
EMS	34
Communication settings	34
Logs	35
Local logs	35
Log to MySQL database	36
EClogic	38
Builder	38
Example	39
Linker	40
Power limit overwrite	40
General Purpose Hysteresis	41
IO	42
Command timers	42
General purpose alarms	43
General purpose timers	44
Monitoring	45
EMS	45
EV Chargers	46
IO module data	47
Simulation Stimuli	48
Service Tool	48
Identifiers	50
Application	50
Settings	52
Power meter configuration	52
IO configuration	53
AIO	55
Sensor Configuration	56
Modbus Tester	56
Client trace	58
Telnet server	58
Boot	59
Identifiers	60
SW update	60
Application	61

Introduction

The ECev from ENcombi is a top-level controller that sits on top of a plant already controlled by an ECpvx or another compatible Energy Management System (EMS). The purpose of the ECev is to limit the power on Electric Vehicle (EV) chargers based on the available power reported by the EMS.

The power limits of the EV chargers are controlled seamlessly via a communication interface between the chargers, EMS, and the ECev. This interface can be either via Modbus RTU running on serial RS485 line or via Modbus TCP running on ethernet dependent on the EV charger vendor and model used.

All interfaces for both the EMS and the EV chargers are pre-embedded and are enabled merely by parameter setting.

All configuration and real time monitoring of the ECev is done by connecting with a standard web browser to its built-in webserver (ECweb). Comprehensive help texts guide you through the configuration setup. ECweb can run on any device featuring a web browser. Use for instance a panel PC as a local HMI. A laptop or portable device which will give you monitoring and control capabilities even from remote if connectivity to the ECev is in place.

It is not mandatory for the control of the EV chargers to work to have an HMI or laptop connected to ECweb. It is required for commissioning of the ECev only.

Besides doing the control of the EV chargers the ECev is also acting as a datalogger. The ECev can make local file loggings on SD card or USB memory stick. These logs can be sent to the customer ftp server or sent to the customer mail account.

Furthermore the ECev can push data to a MySQL server hosted either by ENcombi with ENcombi front-end for data visualization (ECcloud) or customers can choose to push data to their own database and make use of their own data visualization tool. For ECev to upload data to the cloud, an existing ECpvX site is need to link to the ECev.

Data logging functionality and connectivity to the internet is not mandatory for the control of the EV chargers to work.

The schematic below is an example of how ECev are fitted into and interconnected to its surrounding environment.

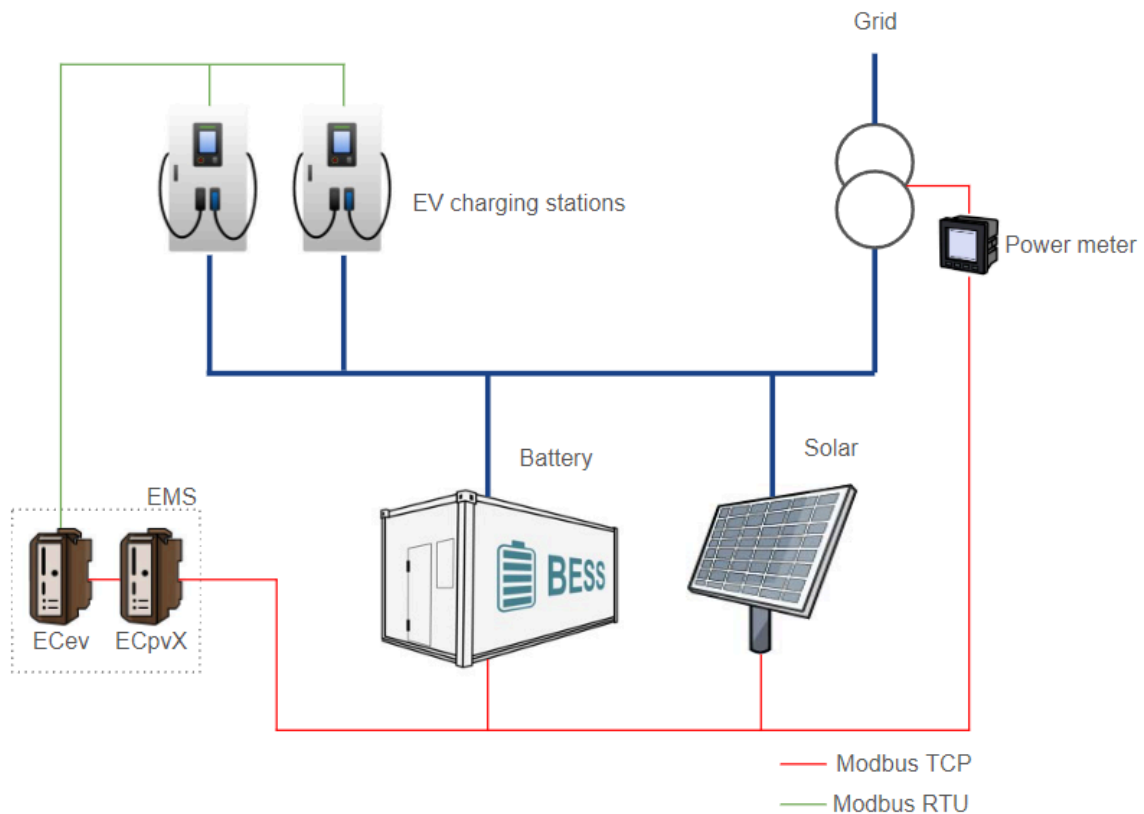

ECweb

ECweb is the built-in webserver of the ECev. All configuration and real time monitoring of the ECev is done via ECweb. Connection to ECweb is done with a standard web browser

Using a laptop/PC and Internet Explorer browser running on Java is the best option for connecting to ECweb. Other browsers and mobile devices can be used as well.

Connecting to ECweb with Internet Explorer or Pale Moon browser on PC/laptop

Java from oracle must be installed on PC/laptop. Java can be downloaded from the link below. Note that either the Internet Explorer or the Pale Moon browser must be used for the download.

[Java download](#)

1: Type in IP address of the ECev in the browser command line.

Default IP address is:

192.168.1.101.

2: Type in login credentials when prompted.

Default login credentials are:

user: web_user0
password: web_password0

3: Accept/Ignore all warnings populated.

4: If tiles on the front page are out of order, click on the page and they will fall into place. If any Icons are missing on the tiles, restart the browser and start over.

Connecting to ECweb using any other browser or mobile device

For all other browsers on PC/laptop or from any browser on mobile devices.

1: Type in IP address/webvisu.html in the browser command line.

Default IP address is:

192.168.1.101.

2: Type in login credentials when prompted.

Default login credentials are:

user: web_user0

password: web_password0

Troubleshooting

If connection can't be established verify that:

1. ECev is powered up and running. ECev must have 24VDC (+/- 15%) supply voltage. The green Power and the green Run LEDs in the front of the ECev must both be illuminated. Note that too low supply voltage can result in a situation where sufficient voltage is present to power up the ECev but not to run the program. In this case the Power LED is illuminated but not the Run LED. When powering up the ECev the Power LED will light up first and the Run LED will come approximately 30s after when ECev is initialized and the program is up and running.
2. Your laptop must be on the same subnet as the ECev. Even though you have an ethernet cable going directly from your laptop to the ECev you still need to make sure that your laptop is provided with a suitable IP address. In the case where the default IP address of the ECev 192.168.1.101 is kept a suitable IP address for your laptop would be 192.168.1.x, where x is a number in the range [2;249] excluding "101" as this is used by the ECev itself.
3. Once the IP of your laptop is in place you must be able to ping the ECev. This can be done by opening a command prompt and writing the command "ping xxx.yyy.zzz.www" where xxx.yyy.zzz.www is the IP address of the ECev as shown below. First when the ECev replies to the command it is verified that your laptop and the ECev can see each other on the network and you can connect to ECweb using the browser as described above.

```
C:\Users\Claus>ping 192.168.1.101

Pinging 192.168.1.101 with 32 bytes of data:
Reply from 192.168.1.101: bytes=32 time=15ms TTL=255
Reply from 192.168.1.101: bytes=32 time=25ms TTL=255
Reply from 192.168.1.101: bytes=32 time=1ms TTL=255
Reply from 192.168.1.101: bytes=32 time=11ms TTL=255

Ping statistics for 192.168.1.101:
    Packets: Sent = 4, Received = 4, Lost = 0 (0% loss),
    Approximate round trip times in milli-seconds:
        Minimum = 1ms, Maximum = 25ms, Average = 13ms
```

Navigating the ECweb

The first page to be displayed after an initial welcome page when connection is established is the front page of ECweb.

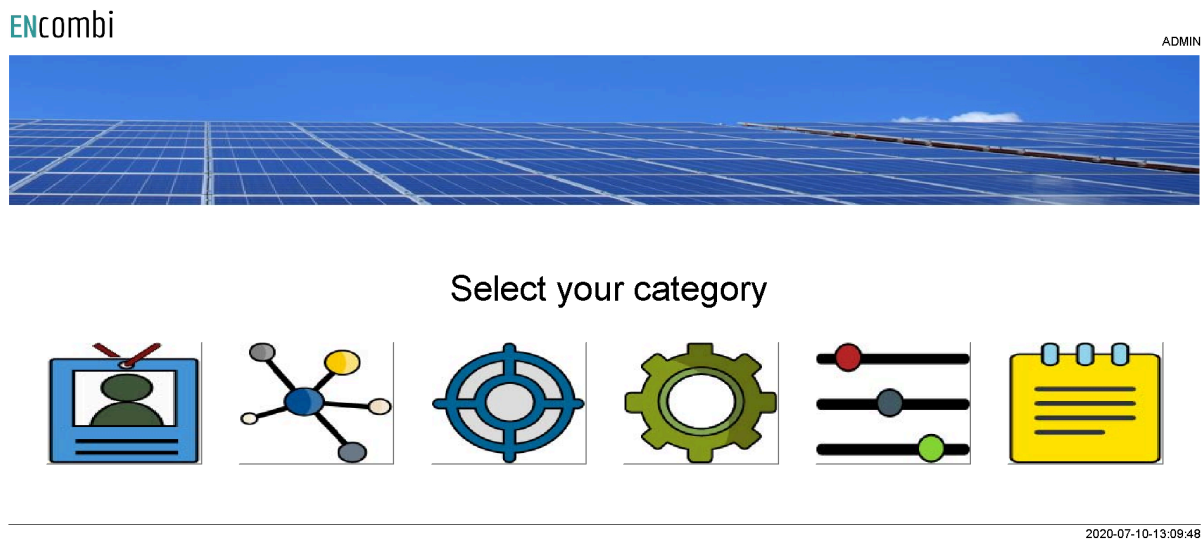

Whenever navigating around the ECweb you can always return to this page by clicking the ENcombi logo in the upper left corner.

In the upper right corner you can see the current access login level. Find more information about this in the chapter revolving password scheme.

In the lower left corner ECev will display any info and warning messages it wants to communicate to the user. Some messages will clear themselves automatically. Others demand user action to be acknowledged first. In that case a dedicated button with a garbage can symbol will be presented alongside the messages. Furthermore when changing certain settings etc. a reboot of the ECev is required before the changes take effect. This will be communicated in the message as well and a dedicated button with refresh symbol will be presented alongside with the messages.

In the lower right corner is the internal clock of the ECev displayed.

In the lower center a total of six menu tiles are available. These are from the left:

1. "Identifiers" gives access to overview of SW version installed and extras present in the ECev as well as set up of project details (name, location etc.), password scheme etc.
2. "EClogic" provides the possibility of making project specific logical expressions when required. That could be for linking physical digital inputs of breakers or similar.

3. "Monitoring" provides a high level overview of the installation as well as detailed information about each individual inverter and power meter.
4. "Control" gives access to set up of ECev controller related parameters such as IP configuration, Internal clock handling etc.
5. "Settings" give access to setup of site specific parameters such as number of EV chargers and power control schemes etc.
6. "Logs" give access to setup of log specific parameters.

In the following chapters the content of the six menu tiles are discussed in detail.

Control

Under this tile set up of ECev controller related parameters for IP configuration, Internal clock handling etc. are found.

IP configuration

First page presented when clicking the Control tile is the page below where IP configuration is set up and connectivity to the gateway can be tested.

ENcombi ADMIN

IP config

IP address: 192.168.1.64

Netmask: 255.255.255.0

Gateway: 192.168.1.1

DNS config

DNS server 01: 8.8.8.8

DNS server 02: 8.8.4.4

IP setup page.
Connectivity to gateway and DNS server can be tested.

Test: 192.168.1.1

2024-06-13-14:10:01

On the right hand side there is one submenu for internal clock configuration.

Internal clock

The internal clock can be synchronized against an NTP server as well as be set manually.

NTP synchronization

First page presented when clicking the clock button is the page below where NTP synchronization can be set up and connectivity to an NTP server and its functionality can be tested.

NTP config

NTP address 1: dk.pool.ntp.org

NTP address 2: 81.88.24.155

UTC: 1

Daylight: EUROPEAN

NTP sync hour: 0:00

NTP: ENABLED



NTP setup page.
Connectivity to an NTP server can be tested.

Test:

188.40.88.13



2020-07-10-13:10:47

On the same submenu level the manual time adjustment of the internal clock is found. Clicking the up/down arrows will lead to it.

Manual time adjustment

On the page below the internal clock can be set manually. The time of the PC connected is presented and can be used to set the ECEV clock against.

Manual config

PC time: 2020-07-10-13:11:14

PLC time:

2020 07 09 13 31 54



Manual device clock adjustment.
PC time shown for reference.

2020-07-10-13:11:12

ECev server access

The ECev features two servers:

1. Telnet server.
2. Web server (ECweb).

ECev Telnet server

On the below page the telnet server access is set up. It is normally not used as it is intended for debug purposes only by tracing various ECev client activities.

Telnet server access in general can furthermore be enabled/disabled.

ENcombi

ADMIN

TELNET Server:

User0: telnet_user0

Password0: *****

Telnet: ENABLED

Telnet server setup page.
Credential is for device telnet server access.
Telnet is usable for tracing various device client activities.

2020-07-10-13:14:30

On the same submenu level the set up of web server access is found. Clicking the up/down arrows will lead to it.

ECev web server (ECweb)

On the page below the web server access is set up.

The HTTP port can be changed. This can be useful if to access ECev from outside the LAN using port forwarding and multiple ECev's or other devices also featuring a web server are connected to the LAN as well.

ENcombi

ADMIN

WEB Server:

User0: web_user0

Password0: *****

HTTP port: 80

WEB server setup page.
Credential is for device WEB server access.
The HTTP port can be changed which can be useful if to setup
port forwarding in a router/gateway to the device.

2020-07-10-13:14:49

Identifiers

Under this tile overview of SW version installed and extras present in the ECev as well as set up of project details (name, location etc.), password scheme etc. are found.

ECev information

First page presented when clicking the Identifiers is the below page where various details about the ECev such as extras available, SW version, serial number etc. Also the MAC address can be found which is to be used when registering the ECev in ECcloud.

ENcombi ADMIN

Company:				
Name:	Website:	Contact:	Support:	Cloud service:
ENcombi	www.encombi.com	sales@encombi.com	support@encombi.com	www.encombi.online
Product:				
Type:	Extras:	Project version:	Serial number:	
ECev	-C-	1.04.0	202406250002	
Platform:				
Device type:	Device variant:	Chip type:	Rtos:	Version:
WP240X	COM	SC24L	V2.08 FULL	V23.9.68.2
Identifiers:				
Serial number 1:	Serial number 2:	MAC address:		
4B97CAF23091C8AD	7171E11FA24D3757	0261096113D1		

2024-09-11-14:18:59

On the right hand side there are four submenus for.

1. Project details
2. Password scheme.
3. Extras.
4. Backups.
5. Application

Project details

Clicking the map icon leads to the project details page. On this page the site name can be changed. This site name can be used to identify the site on ECcloud.

Project details:

Site: ENcombi ECev



Site details setup page.
The site name will be used by the device as the "from-alias" when sending out Emails.

2024-09-11-14:19:42

Password scheme

Clicking the log-in button leads to the below page where the password scheme can be enabled/disabled.

Passw. scheme:

Timeout: 180 s

Scheme: DISABLED

ECpanel

Show passw: DISABLED



Password editing scheme setup page.

The password editing scheme can be enabled/disabled by the administrator.
Level required for editing other settings, start/stop of plant etc. can be configured on dedicated permission setup pages.
If password scheme is disabled, all users logged into web server will have administrator rights.
Default passwords:
Administrator: Password0.
Service: Password1.
Operator: Password2.

The display of the ECpanel password in clear text on the ECpanel can be enabled.

2021-03-31-08:37:58

The password scheme holds four access levels:

1. Administrator.
2. Service.
3. Operator.
4. Viewer.

Required access levels of the various functionalities can be tailored by the customer as shown later. Whenever an attempt is made to alter/activate anything which is not allowed with the current access level, ECev will discard the command and populate a message text informing which access level is required to apply the command.

Viewer level is obtained just by logging on to ECweb.

When to change the access level the upper right text string informing about the current access level is to be clicked. Doing that leads to the below log-in page.

User: ADMIN

Password: *****

Up arrow, Down arrow, Padlock icon

Left arrow button, Right arrow button

When logging in the requested access level and associated password is typed in. When the correct password is typed in the padlock will open. Hereafter the log-in button must be clicked. That will give the selected access level and take you back to the previous page.

When logging out just click the log-out button. The ECev will log out automatically when no editing occurs within the timeout period. Users will be degraded to Viewer level and must log in again as described above to regain the required access level.

When the password scheme is disabled as per default the user will have administrator rights.

Only an administrator can disable the password scheme.

On the same submenu level the set up pages for Operator, Service and Administrator level passwords are found. Clicking the up/down arrows will lead to them.

Passwords

Operator access or high is required for changing the Operator password.

Service access or high is required for changing the Service password.

Administrator access is required for changing the Administrator password.

Three dedicated menus exist for changing the passwords. Below example for changing Operator password.

Operator

Password:



Operator password setup page.
At least operator level login required
for changing operator password.

On the same submenu level the set up pages for tailoring access level required for executing various commands are found. Clicking the up/down arrows will lead to them.

Permissions

The various access levels required are set as below example.

Log

Log setup: SERVICE

Log deletes: SERVICE

MySQL setup: SERVICE

MySQL data: SERVICE

MySQL deletes: SERVICE

Settings

Settings: SERVICE

Counters: SERVICE

EClogic: ADMIN



Permissions setup page.
Setup password level required
for various actions.
Admin level login required for that.

Only an administrator can change the access level required for the various functionalities.

License & Extras

Clicking the extras button leads to the page below where the list of available extras are displayed alongside which of them are present in the ECev. Activation of License as well as upgrading with new Extras are done from here.

ENcombi ADMIN

Extras:

C:  Cloud service

C TRIAL:  Cloud service free trial

License and extras page.
Contact dealer for purchase of license and extras.
When purchased, the license or extras can be fetched online.
The device must have access to the internet.

Search online: 

2024-06-13-14:14:29

After purchase of License or any additional Extra(s) the ECev is upgraded in one of the following ways.

Search online

The ECev will have to be connected to the internet for this approach. Click the binoculars button for "Search online". When successfully completed the ECev will request a reboot.

Backups

Clicking the Backup button leads to the page below where the backups supported by ECev are managed. The ECev provides two backups.



1. Settings.
2. Counters.

Both types can be:

1. Generated and stored locally on internal memory of ECev.
2. Loaded into ECev project from internal memory of ECev.
3. Copied from internal memory of ECev to ENcombi cloud for safe storage.
4. Read from ENcombi cloud to internal memory of ECev.
5. Generated and stored on USB-stick.
6. Loaded into ECev project from USB-stick.

When reading backups from the cloud it will overwrite any existing backup already present on the internal memory of the ECev. The presence of and date of origin of the backups on internal memory are displayed.

By default when reading backups from ENcombi cloud, the ECev will read backups generated by itself. Cloning an ECev can be done by typing in the MAC address of the ECev you intend to clone. Doing this ECpvX will read backups generated by that ECev instead.

Backup	Date	Action
Settings	2020-06-06-10:41:45	
Counters	N.A.	
MAC address:	0030569108A2	





Device backup page.
Following backups can be made:

- 1: Settings backup.
- 2: Counter backup.

The backups are saved and loaded locally on/from the device.
One backup for each function exist only.
Saving a new backup will overwrite any existing backup.

Backups can also be saved and read in/from cloud service.
One backup for each function per device can be saved only.
Reading a backup from cloud service, will overwrite any existing local backup.

Furthermore backups can be saved on and loaded from USB memory stick.

To clone a device, backups created from other devices can be read from the cloud and loaded.
To do so, the MAC address of the device to clone from must be typed in. The refresh button resets to the MAC address of the device itself.

Application

Clicking the Application button leads to the page below. Here it can be selected which application is to be active.

ENcombi

ADMIN

Application

Application: ECEV

Application swap page.
Here it is set up which application to run.
When toggling between applications, the device is to be reboot. Any settings made in the ECEV application will be lost in the process. Store a backup before leaving the ECEV project if any settings are made that is to be restored when reverting to the ECEV application.
Browser needs refreshing when the device has rebooted.

2024-02-22-15:46:59

The following applications are available.

1. ECev.
2. ECev Service Tool.
3. ECev Boot

ECev is the default application and the one to use for the normal operation of the ECev. ECev Service Tool is a separate application that offers various tests and configuration features and the ECev Boot is a tool for updating both the ECev and the ECev Service Tool SW. The ECev Service Tool and the ECev Boot are treated in separate chapters.

When toggling between applications the device is to be rebooted. Any settings made in the ECev application will be lost in the process. Make a backup before leaving the ECev application if any settings are made that are to be restored when reverting to the ECev application once again. The browser needs refreshing when the device is rebooted after switching the application.

Settings

Under this tile the setup of site specific parameters such as number of EV chargers and power control schemes etc. are found.

RS485 COM ports

The Ecev features two RS485 COM ports which are referred to as COM2 and COM3.

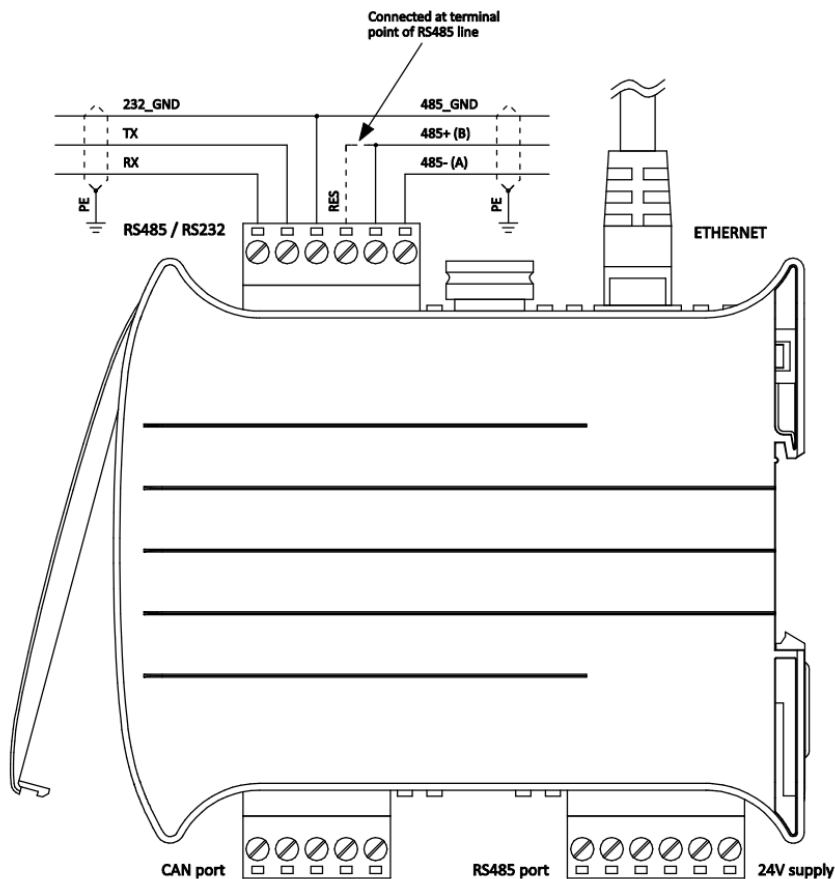

COM2 is the one found next to the power supply and COM3 is the one found next to the ethernet port.

- COM2 is reserved for interfacing to the EMS.
In case none of this is enabled, COM2 is acting as a slave port.
- COM3 is reserved for interfacing to EV charging stations.
In case none of this is enabled, COM3 is acting as a slave port.

First page presented when clicking the Settings tile is the page below where COM2 configuration is set up.

COM2 port

Baudrate:	9600
Parity:	NO PARITY 1 STOP BIT
Timeout:	0.3 s
TX rate:	0.1 s
Slave ID:	1



COM2 Port setup page.
Baudrates supported are 9600, 19200, 38400 and 115200.
EMS RTU communication is fixed on COM2.
IO module RTU communication is optional on COM2.
In case none of these communications are enabled, COM2 is serving as a Modbus RTU slave.
Slave ID is only used in case COM2 is serving as a slave.



2024-06-13-14:16:28

Baud rates supported are:

- 9600, 19200, 38400 and 115200

Parity supported are:

- "Parity one stop bit", "No parity", "Even parity" and "Odd parity".

When a COM2 port is acting as a master, the transmit rate can be used to control the rate at which the ECev transmits to the slaves.

The Slave ID is only used when a COM2 port is acting as a slave.

On the same menu level a similar setup page for COM3 configuration is found. Clicking the up/down arrows will lead to it.

On the right hand side there are five submenus for.

1. Alarm related parameters.
2. IO module related parameters.
3. EV charger related parameters.
4. EMS related parameters.
5. Simulation Parameters.

Alarms

Clicking the alarm button leads to menus of customizable alarms.

- Master alarms
- COM2 port slave alarm.
- COM3 port slave alarm.

- TCP port slave alarm.
- Common comm alarm

Other alarms exist as well but they are not customizable alarms as the ones listed above.

Master Alarms

ENcombi ADMIN

Master alarms

EV:	10
EMS:	10
IO:	10

Modbus master communication alarm setup page.
The number of timeouts to encounter before the respective alarm is raised can be set here. This way the sensitivity of the various Modbus Master related communication alarms can be adjusted.

2024-06-13-14:21:11

Here the sensitivity of the Modbus Master communication alarms can be adjusted. The settings dictates the number of timeouts to encounter before the respective Modbus Master alarm is raised.

COM2 slave

ENcombi ADMIN

COM2 slave

Delay:	5.0 s
Enable:	DISABLED
Signal:	DISABLED
Auto ack.:	DISABLED

COM2 slave alarm setup page.
When no frames are received from modbus master the alarm condition is present.
When condition has been present for a periode equal to or longer than the delay and in case the alarm is enabled, the alarm is provoked.
When alarm is provoked, the signal selected will be activated and the action selected will be taken.
The alarm is automatically acknowledged in case auto ack. is enabled.

2024-06-13-14:23:02

When no frames are received from the modbus RTU master, the alarm condition is present. When the condition has been present for a period equal to or longer than the delay and in case the alarm is enabled, the alarm is provoked. When the alarm is

provoked, the signal selected will be activated and the action selected will be taken. The alarm is automatically acknowledged in case auto ack. is enabled.

COM3 slave

COM3 slave

Delay:	5.0 s
Enable:	DISABLED
Signal:	DISABLED
Auto ack.:	DISABLED



COM3 slave alarm setup page.
 When no frames are received from modbus master the alarm condition is present.
 When condition has been present for a periode equal to or longer than the delay and in case the alarm is enabled, the alarm is provoked.
 When alarm is provoked, the signal selected will be activated and the action selected will be taken.
 The alarm is automatically acknowledged in case auto ack. is enabled.

2024-06-13-14:23:17

When no frames are received from the modbus RTU master, the alarm condition is present. When the condition has been present for a period equal to or longer than the delay and in case the alarm is enabled, the alarm is provoked. When the alarm is provoked, the signal selected will be activated and the action selected will be taken. The alarm is automatically acknowledged in case auto ack. is enabled.

TCP slave

TCP slave

Delay:	5.0 s
Enable:	DISABLED
Signal:	DISABLED
Auto ack.:	DISABLED



TCP slave alarm setup page.
 When no frames are received from modbus master the alarm condition is present.
 When condition has been present for a periode equal to or longer than the delay and in case the alarm is enabled, the alarm is provoked.
 When alarm is provoked, the signal selected will be activated and the action selected will be taken.
 The alarm is automatically acknowledged in case auto ack. is enabled.

2024-06-13-14:32:00

When no frames are received from the modbus TCP master, the alarm condition is present. When the condition has been present for a period equal to or longer than the delay and in case the alarm is enabled, the alarm is provoked. When the alarm is

provoked, the signal selected will be activated and the action selected will be taken. The alarm is automatically acknowledged in case auto ack. is enabled.

Common master communication

Comm alarm

Delay:	60.0 s
Enable:	ENABLED
Signal:	DISABLED
Auto ack.:	ENABLED



Common modbus master communication alarm setup page.
 When any modbus master communication alarm is triggered,
 then the alarm condition is present.
 When the condition has been present for a periode
 equal to or longer than the delay, and in case
 the alarm is enabled, the alarm is provoked.
 When the alarm is provoked, the signal selected
 will be activated and the action selected will be taken.
 The alarm is automatically acknowledged
 in case auto ack. is enabled.

This alarm condition is present in case any of the modbus master communication alarms for the inverter, power meter, sensor or IO communication are raised. When the condition has been present for a period equal to or longer than the delay and in case the alarm is enabled, the alarm is provoked. When the alarm is provoked, the signal selected will be activated and the action selected will be taken. The alarm is automatically acknowledged in case auto ack. is enabled.

IO modules

Clicking the IO module button leads to the following page.

ENcombi VIEWER

IO modules	
COM port:	COM2
IO 1:	OFF
IO 2:	OFF
IO 3:	OFF
IO 4:	OFF

IO module setup page.
 IO module communication can either run Modbus RTU or Modbus TCP.
 Whether to use COM2, COM3 or TCP is selectable by parameter.
 Port settings is setup at dedicated port setup page.

2021-01-22-17:11:09

Above page holds the setting up Modbus IO module communication. IO module communication runs either Modbus RTU or Modbus TCP. Whether to use IO modules on COM2, COM3 or TCP is selectable by parameter. A maximum of 4 Modbus IO modules can be connected to the ECev. The ECev can also read IO data directly from another ECev. This is selectable by parameter.

Check the link below to see which IO modules that are supported by ECev.

<http://www.encombi.com/products/eccev/>

Clicking the up/down arrows leads to the page below where the Modbus ID and IP addresses for the respective IO modules are set up.

ENcombi ADMIN

IO modules	
IO 1 ID:	1
IO 1 IP:	192.168.1.50
IO 2 ID:	1
IO 2 IP:	192.168.1.50
IO 3 ID:	1
IO 3 IP:	192.168.1.50
IO 4 ID:	1
IO 4 IP:	192.168.1.50

IO module setup page.
 Modbus RTU ID of the IO modules is selectable by parameter.
 Modbus TCP IP of the IO modules is selectable by parameter.
 The Modbus ID selected is used in the TCP frames.

2021-01-24-11:56:05

Analogue input/output

The ECev supports analogue input/output modules. When the analogue module is selected in the IO window setup, all settings are placed in the monitoring of the IO module.

The screenshot shows the ENcombi monitoring interface. At the top left is the ENcombi logo. On the right, there is an 'ADMIN' label and a vertical stack of navigation icons: a red arrow pointing up, a power button, a battery icon, and a yellow 'I/O' button. The main content area displays several data points:

- EMS Capacity:** 0.0 kW
- EMS Production:** 0.0 kW
- EV Load:** 0.0 kW
- External Load:** 0.0 kW
- References:**
 - PTAR: 0.0 kW
 - PREF: 0.0 kW
- Imported:**
 - ACE: 0 kWh
 - ACE YEAR: 0 kWh
 - ACE MONTH: 0 kWh
 - ACE DAY: 0 kWh

At the bottom right, the timestamp '2024-06-13-14:37:05' is visible.

When pressing the IO button, it will lead to the following page.

The screenshot shows the ENcombi IO modules configuration page. At the top left is the ENcombi logo. On the right, there is an 'ADMIN' label and a vertical stack of navigation icons: a red arrow pointing up, a power button, a battery icon, and a yellow 'I/O' button. The main content area is a table with the following columns: IO modules, IO type, IO inputs, IO outputs, Communication state, and Communication enable. The table contains four rows of data:

IO modules	IO type	IO inputs	IO outputs	Communication state:	Communication enable:
IO 1:	EX1608DD	0011 0000 0000 1100	0000 0000 0000 0000	Communication state:	Communication enable:
IO 2:	OFF	N.A	N.A	Communication state: N.A	Communication enable: N.A
IO 3:	OFF	N.A	N.A	Communication state: N.A	Communication enable: N.A
IO 4:	OFF	N.A	N.A	Communication state: N.A	Communication enable: N.A

At the bottom right, the timestamp '2024-02-23-08:59:40' is visible.

From this page it is possible to select which IO module to set up and monitor values. If the IO module is digital input/output, it is not possible to click on the module, the actual bit value is present at this page. By clicking on the IOx module, it will lead to the following page.

IO2	AIO type	Value	PCT	Minimum Scale	Maximum Scale	State:
Channel 1:	INPUT	1500.0	36.6 %	0.0	4095.0	Normal
Channel 2:	INPUT	2000.0	48.8 %	0.0	4095.0	Normal
Channel 3:	OUTPUT	0.0	0.0 %	0.0	4095.0	Normal
Channel 4:	OFF	N.A	N.A	0.0	4095.0	N.A



Module temp: 32.2 C
 Communication state:

2022-02-07-14:16:54

From this page it is possible to scale the input/output on each channel of the IO module. The input value can be used for Pref, Qref or other data points. This is set in EClodic. The value shown is the scaled value and the percentage is the percentage of the range from 0-100%. The maximum range is 0-4095.

The module temperature is shown in the lower right corner and the state of each channel can be read to the right.

EV Charging stations

Settings

Clicking the EV charger button leads to the below page where the settings for the charging stations can be adjusted.

EV Charger

Min EV Load:	5.0 kW
PV charging:	DISABLED
PV charging limit:	100.0 %
DC mode:	DISABLED



EV charging station setup page.

The minimum power limit for EV charging stations can be set here. The minimum power limit will be divided evenly among all guns on each station, if possible.

When PV charging is enabled, the total active power from PV inverters is used as generating capacity.

PV charging limit determines what percentage of the PV power output is available for EV charging stations to use. The PV charging limit does not apply in DC mode.

DC mode is used when the EV charging stations are connected to the DC bus behind the PCS from the EMS's point of view.

When enabled, Mains and Genset capacities are disregarded and the battery capacity is determined from the BMS and not the PCS.

If the PCS "charges" the battery from the AC bus, the corresponding power will be added to the generating capacity of the EMS.

When both PV charging and DC mode are enabled, DCPV power will be added to the total generating capacity instead of the total PV inverter active power.

2024-10-08-09:58:20

The minimum EV load defines the minimum power limit that the control can apply. Some charging stations require a power limit above 0 to be able to start the charging process. The

minimum power limit is distributed evenly between all guns on the station based on the Guns per station setting.

PV charging makes the active power produced by PV inverters available for the EV charging stations to use. The PV charging limit defines the percentage of the current active power that is made available for EV charging stations.

DC mode is used when the charging station is connected to the DC bus of the battery instead of the AC bus. When enabled, mains and genset generating capacities are disregarded and the batteries generating capacity is determined from the BMS instead of the PCS. If the PCS is used by the EMS controller to charge the battery, the corresponding power is added to the total generating capacity. Equivalently, if the PCS is used to discharge the battery to the grid, the corresponding power is subtracted from the total generating capacity available to the charging stations.

When both DC mode and PV charging are enabled, the DCPV power will be added to the total generating capacity instead of the total active power from PV inverters.

Ratings

Clicking the “up” arrow leads to the page where rated values of the EV charging station installation are set up.

Rated

EV 1:	100.0 kW
EV 2:	100.0 kW
EV 3:	100.0 kW
EV 4:	100.0 kW
EV 5:	100.0 kW
EV 6:	100.0 kW
EV 7:	100.0 kW
EV 8:	100.0 kW



EV Rated Power

The Rated Active Power setting determines the maximum power limit per station.

The ECev supports up to 32 EV charging stations at the same time. The rated power can be adjusted for each station individually.

Guns/charging points

Scrolling up or down, past all rated power settings, leads to the number of charging guns per station setting. The number of charging guns/charging points per station can be set individually for each station. The ECev will collect the current state and sometimes a unique car ID from each gun/charging point up to the number of guns per station.

Guns per station:

EV 1:	1
EV 2:	1
EV 3:	1
EV 4:	1
EV 5:	1
EV 6:	1
EV 7:	1
EV 8:	1



Number of Guns per EV charging station

The number of guns per EV charging station setting determines for how many guns data is acquired from for each station.
This setting reduces unnecessary data acquisition time.

2024-06-25-15:04:23

Counters

On the same submenu level pages for various EV related counters are found. Clicking the up/down arrows will lead to them. These counters show the amount of energy consumed by the EV charging stations in total, yearly, monthly, and daily.

Below is an example.

Produced	Active	Update
ACE:	0 kWh	<input type="text" value="0 kWh"/>
ACE YEAR:	0 kWh	<input type="text" value="0 kWh"/>
ACE MONTH:	0 kWh	<input type="text" value="0 kWh"/>
ACE DAY:	0 kWh	<input type="text" value="0 kWh"/>



EV energy production counters preset page.

Counters with checkmark in the update column will be preset with keyed in value when save button is pressed. Toggle between checkmark and crossmark by pressing the button.

2024-09-11-14:28:28

The counters will be incremented automatically by the ECev in accordance with operation conditions. The counters are part of the counters backup discussed in the Identifier chapter.

The menus are only providing the possibility for manually presetting of the counters. Counters with a check mark in the update column will be preset with the keyed in value when the save button is pressed. Toggle between check mark and cross mark by pressing the respective buttons.

Communication settings

Clicking the EV charging station icon leads to the general communications settings page.



The screenshot shows the ENcombi web interface. On the left, there is a table of settings for the EV Charger:

EV Charger	
Protocol:	OFF
Modbus type:	RTU
Control Fnc:	0x10
Control:	ENABLED
Data acquisition:	ENABLED
Nbr EV Chargers:	3

On the right side of the interface, there is a section titled "EV Charging Station Setup page." with a warning message: "The device can interface to EV Chargers via Modbus RTU or Modbus TCP. The data read from the EV Chargers will be visualized on dedicated page." Above this message are icons for editing (pencil) and navigation (up/down arrows). In the top right corner, there is an "ADMIN" label and a red arrow icon pointing upwards.

At the bottom right of the screenshot, the date and time "2024-06-17-08:49:14" are displayed.

All charging stations controlled by a single ECev must be of the same vendor and possibly model. The communication can either be RTU or TCP. Check the link below to see which inverters are supported by ECev.

<http://www.encombi.com/products/ecev/>

Should your preferred EV charging station not be on the list already, contact ENcombi to request the adding of it.

Controlling the EV charging stations and data acquisition from the charging stations can be enabled/disabled independently. ECev supports Modbus function code 0x06 and 0x10 for applying control commands. Some EV chargers support only one of the two. Consult the Modbus Master documentation on ENcombi website to learn which function code to use with your EV charging station:

<http://www.encombi.com/products/ECev/>

If data acquisition is enabled, the data read from the inverters, will be visualized on dedicated pages under monitoring.

RTU

On the same submenu level the page for setting up Modbus RTU specifics for EV charging station communication is found. Clicking the up/down arrows will lead to it.

RTU

Control type: UNICAST

Broadcast ID: 0

Control ID: 1

Acquisition ID: 1

**EV Charger interface via Modbus RTU setup page.**

The device can apply references as Unicast or as Broadcast. Unicast is applicable when interfacing to a single unit. This being a single inverter or a controller managing a pool of inverters. Broadcast is applicable for controlling a pool of inverters without the presents of a managing controller.

The modbus broadcast ID is configurable. Default and modbus standard is 0.

The Control ID is used for Unicast. If a managing controller is present the Control ID is to match that device. If no managing controller is present, the Control ID shall be set equal to the Acquisition ID.

The Acquisition ID shall be set equal to the lowest EV Charger ID present. When Acquisition enabled the device will read data from the EV Chargers.

The device will read from Acquisition ID an onwards, until the number of EV Chargers selected is reached. The IDs of the EV Chargers must be sequential.

2024-02-28-13:36:13

The ECev can apply references as Unicast or as Broadcast. Unicast is applicable when interfacing to a single unit. This being a single EV charging station or a controller managing a pool of charging stations. Broadcast is applicable for controlling a pool of EV charging stations without the presence of a managing controller.

The Control ID is used for Unicast. If a managing controller is present the Control ID is to match that device. If no managing controller is present, the Control ID shall be set equal to the Acquisition ID.

If the EV charging stations do not support Broadcast, a pool of charging stations can still be controlled using Unicast. In this case Control ID shall be set equal to the Acquisition ID.

The Acquisition ID shall be set equal to the lowest EV charging station ID present. When Acquisition enabled the device will read data from the charging stations. ECev will read from Acquisition ID and onwards, until the number of EV charging stations selected is reached. The IDs of the EV charging stations must be sequential.

TCP

On the same submenu level the page for setting up Modbus TCP specifics for EV charging station communication is found. Clicking the up/down arrows will lead to it.

TCP

Control IP: 192.168.1.66

Acquisition IP: 192.168.1.66



EV Charger interface via Modbus TCP setup page.

When controlling a pool of EV Chargers, without the presents of a managing controller, the Control IP is to be set differently than the Acquisition IP. The RTU Initialization ID is in this case used for any initialization frames. The RTU Control ID is in this case used for all other frames. The IP addresses of the EV Chargers must be sequential.

When controlling a single inverter or a pool of EV Chargers with the presents of a managing controller, the Control IP is to be set equal to the Acquisition IP. The RTU Initialization ID is used for any initialization frames. The RTU Control ID is used for the control frames. The RTU Acquisition IDs are used for the data acquisition frames.

2024-02-28-13:39:24

When controlling a pool of EV charging stations, without the presence of a managing controller, the Control IP is to be set differently than the Acquisition IP.

When controlling a single EV charging station or a pool of charging stations with the presence of a managing controller, the Control IP is to be set equal to the Acquisition IP.

EMS

Clicking the EMS icon leads to the below page where the SOC limits are set up.

ENcombi

ADMIN

SOC Hysteresis

Enable:	DISABLED
Upper Limit	80.0 %
Lower Limit	20.0 %
Safety Margin	0.0 %



Battery SOC Hysteresis settings.

The Enable settings enables the Battery SOC hysteresis.
 DISABLED: The hysteresis is disabled.
 ENABLED: The Hysteresis is enabled and the upper and lower limits from this page are used.
 EMS: The hysteresis is enabled and the highest enabled upper and lower SOC limits from the EMS are used.

Safety Margin is only used when EMS is chosen as the source of the limits. The margin is subtracted from the upper limit and added to the lower limit.

2024-06-13-14:47:40

The SOC hysteresis settings can be enabled here. This setting allows the EMS to charge the battery without being interrupted by the EV charging stations. For more information about the SOC limits please refer to the ECpvX User manual.

When the SOC reaches the lower limit, the battery's charging capacity is considered unavailable by the ECev until the SOC reaches the upper limit. NOTE that the controlling EMS still has priority when it comes to charging/discharging the battery.

Furthermore, an EMS mode can be chosen instead of enable/disable. In EMS mode the ECev automatically determines the range of SOC where the EMS will not choose to charge the battery. This way the ECev will not trigger any charging/discharging limits from the EMS.

The Safety Margin setting defines a margin around the EMS acquired SOC limits.

Clicking the EMS icon to the right leads to the EMS communication settings

Communication settings

On the below page the EMS configuration is configured.

EMS

Protocol: OFF
 Modbus type: RTU
 Acquisition ID: 1
 Acquisition IP: 192.168.1.50



EMS Communication Setup page.
 The device can interface to EMS via Modbus RTU or Modbus TCP.
 The data read from the EMS will be visualized on dedicated page.

2024-06-13-14:55:12

The ECev is able to communicate with the EMS via RTU or TCP. The data acquisition can be enabled separately.

When RTU is used the ECev will read from the Acquisition ID.

When TCP is used the ECev will read from the Acquisition IP.

Logs

The ECev offers logging both locally on SD-card or USB-stick.

Local logs

The ECev features logging stored locally on SD-card or on USB stick.

The ECev can make one log: Event log.

The logs are stored locally on ECev; either on SD-card or on USB-stick.

Log config

Log drive: SD-card
 Event log: DISABLED
 Log rate: 5 min



Log setup page.
 USB-key or SD-card can be used for logging.
 Use of USB-key recommended to avoid wearing SD-card.
 Three logs can be enabled/disabled independently.
 Event-log holds events and alarms.
 Summary-log holds the result of a days production.
 Production-log holds fixed interval loggings of production during a day.
 The logs can be read directly on web server as well as be transmitted via ftp or mail.
 Selected storage media must hold a "Logs" folder in the root directory.

Event log:



2024-02-23-09:39:55

A new Event log is generated every day. The event log holds entries of any events taking place or any occurrences of alarms on that particular day. All entries are time stamped. The event log can be displayed directly on ECweb. Below is an example of the event log and how it looks on ECweb. First page is a list of all the event logs available. Second page shows data from one of those logs:



Log to MySQL database

The ECEv can push time series data to a MySQL database as well. This can be to an installer/customer's own hosted database or it can be to an ENcombi hosted database.

Log config

Host: mysqlhost.com

Database: mysql_database

Username: mysql_username

Password: *****

Table name: mysql_tablename

Log rate: 5 min

Log: ENABLED

Cloud service: ENABLED



MySQL setup page.

When enabled, the device creates a table in the selected MySQL database should it not already be present. Afterwards the device pushes data to the table at the interval selected.

Tailor the data elements the device pushes and use your own MySQL database and preferred visualization tool. Alternatively use the Cloud service provided with the C-extra. In this case the table name and above settings are disregarded. Also the data elements pushed are fixed and can't be tailored.

In case connection to the MySQL database is lost, the device buffers data to local file and will be transferred once connection is re-established. local buffer file as well as the table in the database itself can be deleted from designated buttons.

Your device can come with free cloud service in a trial period. Below you can see if you have any free trial days available. Find the cloud service provider on the Identifiers page.

Buffer size:	<input type="text" value="0.0 kB"/>	
Table size:	<input type="text" value="27090"/>	
Free trial:	<input type="text" value="90 days"/>	

2020-07-10-13:55:57

When using an installer/customer hosted database the data visualization part is in the scope of the installer/customer as well. The data to push is configurable according to the MySQL documentation on ENcombi website:

<http://www.encombi.com/products/ecev/>

The option of using the ENcombi database requires the dedicated SW-extra "C" or time left of any complimentary free "C" trial period. The data pushed to the ENcombi database is fixed from ENcombi side and can't be tailored by installer/customer. The front-end for data visualization provided by ENcombi is called ECcloud. After the controlling ECpvX has started pushing data to the ENcombi database the customer/installer can register it in ECcloud. The Ecev can then be registered with the ECpvX and start pushing data into the cloud.

www.encombi.online



Welcome to ECcloud

Please enter your credentials

EClogic

EClogic provides the possibility of making project specific logical expressions when required. That could be for linking physical digital inputs applied on power meters to the position of circuit breakers or similar. First page presented when clicking the EClogic tile is the page below.

EClogic main page.

EClogic is a collection of logical features to use for site customization.

The Builder offers the possibility of logically combining various input states. This is done via graphical representation of logical gates. Say multiple breakers/contactors need to be in certain position before the PV plant is connected to Grid, this can be tailored in the Builder. The input to the gates are Modbus addresses and bitmasks. It will typically be addresses holding digital input statuses from various power meters. Consult the Modbus Slave documentation to identify the addresses of the inputs to use. Note that the default input address "0" is interpreted as "not used". The output of the gates are status set on dedicated Modbus addresses. Consult the Modbus Slave documentation to identify the addresses of the outputs generated. These statuses can then be used in the Linker to generate a command to the device.

The Linker offers the possibility of linking input states to commands. The input states are Modbus addresses and bitmasks. It will typically be addresses holding digital input statuses from various power meters or it can be addresses holding output status generated through the Builder. Consult the Modbus Slave documentation to identify the addresses of the inputs to use. Note that the default input address "0" is interpreted as "not used". The commands available are predefined commands on dedicated Modbus addresses. Consult the Modbus Slave documentation to identify the addresses of the available commands.

The RRCR is a dedicated configuration setup of RRCR functionality. 16 unique Power reference levels based on 4 input combinations can be configured.



EClogic is divided into five sub categories.

1. Builder
2. Linker
3. IO
4. Command timers
5. Alarms

Builder

The Builder offers the possibility of logically combining various input states. This is done via graphical representation of logical gates. Say multiple breakers/contactors need to be in a certain position before the PV plant is connected to the Grid, this can be tailored in the Builder.

The input to the gates are function code 0x04 Modbus addresses and bitmasks. It will typically be addresses holding digital input statuses from various power meters. Consult the Modbus Slave documentation to identify the addresses of the inputs to use. Note that the default input address "0" is interpreted as "not used".

The output/status of the gates are set on dedicated Modbus addresses. Consult the Modbus Slave documentation to identify the addresses of the outputs generated. These statuses can then be used in the Linker to generate a command to the device.

First page presented when clicking the builder button is the page below. Here an overview of the 16 builder lines supported is presented.

2020-07-10-14:00:11

Each builder line consists of four gates. The status of the gates are represented by the color. Red means that the gate is false and green that the gate is true.

2020-07-10-14:00:34

Clicking the line number will lead to the set up page for the specific line.

Each of the first three gates take four AND inputs and four AND NOT inputs. These three inputs are OR'ed together to generate one input to the output gate.

Example

In the configuration shown above, address 3397 bit0 is used as input to Gate1. From Modbus Slave documentation this is found to be input1 on PV meter1. As the input1 is active the Gate1 state is true which again results in the output gate to be true. This will generate the following statuses in the designated modbus area to go high.

ECLOGIC BUILDER AREA 1				
28000	Q1 gate output status line 1-16	16 unsigned int	bitwise	Not defined
28001	Q2 gate output status line 1-16	16 unsigned int	bitwise	Not defined
28002	Q3 gate output status line 1-16	16 unsigned int	bitwise	Not defined
28003	Q-out gate output status line 1-16	16 unsigned int	bitwise	Not defined
28004	Inverted Q-out gate output status line	16 unsigned int	bitwise	Not defined
28005...28999	RESERVED	Not defined	Reserved for later use	Not defined

Address 28000 bit0: Gate1, line1
 Address 28003 bit0: Output Gate, line1

Linker

The Linker offers the possibility of linking input states to commands. The input states are Modbus addresses and bitmasks. It will typically be addresses holding digital input statuses from various power meters or it can be addresses holding output status generated through the Builder. Consult the Modbus Slave documentation to identify the addresses of the inputs to use. Note that the default input address "0" is interpreted as "not used".

The commands available are predefined commands on dedicated Modbus addresses. Consult the Modbus Slave documentation to identify the addresses of the available commands.

First page presented when clicking the linker button is the page below. Here the 32 linker lines supported can be set up. Furthermore, the status of each link is indicated by green and red color.

ADMIN

INPUTS				OUTPUTS				INPUTS				OUTPUTS			
Line	Address	Bit	Status	Address	Bit	Status	Line	Address	Bit	Status	Address	Bit	Status		
Line:1	28003	0	■	29019	0	■	Line:17	0	0	■	29000	0	■		
Line:2	28003	0	■	29053	7	■	Line:18	0	0	■	29000	0	■		
Line:3	28003	0	■	29055	2	■	Line:19	0	0	■	29000	0	■		
Line:4	0	0	■	29000	0	■	Line:20	0	0	■	29000	0	■		
Line:5	0	0	■	29000	0	■	Line:21	0	0	■	29000	0	■		
Line:6	0	0	■	29000	0	■	Line:22	0	0	■	29000	0	■		
Line:7	0	0	■	29000	0	■	Line:23	0	0	■	29000	0	■		
Line:8	0	0	■	29000	0	■	Line:24	0	0	■	29000	0	■		
Line:9	0	0	■	29000	0	■	Line:25	0	0	■	29000	0	■		
Line:10	0	0	■	29000	0	■	Line:26	0	0	■	29000	0	■		
Line:11	0	0	■	29000	0	■	Line:27	0	0	■	29000	0	■		
Line:12	0	0	■	29000	0	■	Line:28	0	0	■	29000	0	■		
Line:13	0	0	■	29000	0	■	Line:29	0	0	■	29000	0	■		
Line:14	0	0	■	29000	0	■	Line:30	0	0	■	29000	0	■		
Line:15	0	0	■	29000	0	■	Line:31	0	0	■	29000	0	■		
Line:16	0	0	■	29000	0	■	Line:32	0	0	■	29000	0	■		

2020-07-10-14:01:41

Power limit overwrite

The power limit that the ECev calculates for each charging station can be overwritten or limited by the power limit overwrite ECLogic command register. Eight power limits can be chosen as percentages of the rated power. This percentage applies to all present EV charging stations.



Address:	Bit:		Power Limit	Enable:
29076	0	<input type="checkbox"/>	0.0 %	DISABLED
29076	1	<input type="checkbox"/>	0.0 %	DISABLED
29076	2	<input type="checkbox"/>	0.0 %	DISABLED
29076	3	<input type="checkbox"/>	0.0 %	DISABLED
29076	4	<input type="checkbox"/>	0.0 %	DISABLED
29076	5	<input type="checkbox"/>	0.0 %	DISABLED
29076	6	<input type="checkbox"/>	0.0 %	DISABLED
29076	7	<input type="checkbox"/>	0.0 %	DISABLED

2024-06-13-15:24:57

Choosing ENABLED overwrites the power limit and sets it to exactly the chosen percentage of each EV charging stations rated power.

Choosing LIMIT allows the power limit to drop below the chosen percentage but not exceed it.

General Purpose Hysteresis

General purpose hysteresis is a generic configuration tool to trigger alarms based on different inputs.

General purpose hysteresis enables you to trigger a status in modbus based on thresholds limits of various measurements. Via the EClogic Builder/Linker the status triggered can be used to activate relates, set an ECloig general purpose alarm etc. A total of 8 such hysteresis are available.



Address:	Data type:	Data sign:	Low Threshold:	High Threshold:	Low Timer:	High Timer:	Output:	Set:	Reset:	Invert:
0	16BIT	SIGNED	0.0	0.0	0.0 s	0.0 s	<input type="checkbox"/>	<input type="checkbox"/>	<input type="checkbox"/>	<input checked="" type="checkbox"/>
0	16BIT	SIGNED	0.0	0.0	0.0 s	0.0 s	<input type="checkbox"/>	<input type="checkbox"/>	<input type="checkbox"/>	<input checked="" type="checkbox"/>
0	16BIT	SIGNED	0.0	0.0	0.0 s	0.0 s	<input type="checkbox"/>	<input type="checkbox"/>	<input type="checkbox"/>	<input checked="" type="checkbox"/>
0	16BIT	SIGNED	0.0	0.0	0.0 s	0.0 s	<input type="checkbox"/>	<input type="checkbox"/>	<input type="checkbox"/>	<input checked="" type="checkbox"/>
0	16BIT	SIGNED	0.0	0.0	0.0 s	0.0 s	<input type="checkbox"/>	<input type="checkbox"/>	<input type="checkbox"/>	<input checked="" type="checkbox"/>
0	16BIT	SIGNED	0.0	0.0	0.0 s	0.0 s	<input type="checkbox"/>	<input type="checkbox"/>	<input type="checkbox"/>	<input checked="" type="checkbox"/>
0	16BIT	SIGNED	0.0	0.0	0.0 s	0.0 s	<input type="checkbox"/>	<input type="checkbox"/>	<input type="checkbox"/>	<input checked="" type="checkbox"/>
0	16BIT	SIGNED	0.0	0.0	0.0 s	0.0 s	<input type="checkbox"/>	<input type="checkbox"/>	<input type="checkbox"/>	<input checked="" type="checkbox"/>

2021-09-21-10:45:13

The address column is the input for the hysteresis. The data type and sign for the selected address must be changed according to the modbus manual for the address. The hysteresis is built up with a low threshold and a high threshold.

If the value from the address is lower than the low threshold value, the low timer will start. After the lower timer has expired, the output box will change color to green which indicates that the line is present. The status of each line can also be read out on modbus.

If the value from the address is higher than the high threshold value, the high timer will start. After the high timer expires, the output box will change color to red which indicates that the line is not present any more.

It is possible to manually force the line to be set or reset by clicking on the buttons corresponding to the line which should be forced.

Furthermore it is possible to inverse the output by clicking the button.

The hysteresis output status can be used in the EClogic Builder/Linker using the addresses below.

31014	BITFIELD_15	16 unsigned int	EClogic Threshold output 01..16
-------	-------------	-----------------	---------------------------------

IO

By clicking on the IO icon, it will lead to the following page.



Address:	Data type:	Data sign:	Module.Channel	Address:	Data type:	Data sign:	Module.Channel
0	16BIT	SIGNED	→ 1.1	0	16BIT	SIGNED	→ 3.1
0	16BIT	SIGNED	→ 1.2	0	16BIT	SIGNED	→ 3.2
0	16BIT	SIGNED	→ 1.3	0	16BIT	SIGNED	→ 3.3
0	16BIT	SIGNED	→ 1.4	0	16BIT	SIGNED	→ 3.4
0	16BIT	SIGNED	→ 2.1	0	16BIT	SIGNED	→ 4.1
0	16BIT	SIGNED	→ 2.2	0	16BIT	SIGNED	→ 4.2
0	16BIT	SIGNED	→ 2.3	0	16BIT	SIGNED	→ 4.3
0	16BIT	SIGNED	→ 2.4	0	16BIT	SIGNED	→ 4.4

From here it is possible to set up which data should be linked to each output of the AIO module. All 16 outputs are present and it is possible to select which data to be sent out on each channel.

Command timers

By clicking on the command timer icon, it will lead to the following page.

Command timers 1

Start day: Mon-Sun
 Start hour: 18 h
 Start minute: 0 min
 Stop hour: 6 h
 Stop minute: 0 min



Command timer setup page.
 Here the command timer period can be defined using the command time start and command time stop settings.
 The output will be placed in modbus.



2023-02-06-23:22:58

It is possible to set up 4 command timers. Type in the start day and time and stop time for the command timer. The output will be available on Modbus and can be used for EClologic status/commands.

General purpose alarms

General purpose alarms enable you to trigger your own custom made alarm. Via the EClologic Builder/Linker the trigger for the alarm is set up. A total of 8 such alarms are available.

ECLogic alarm 1

Delay: 5.0 s
 Signal: DISABLED
 Action: NOTIFICATION
 Auto ack.: ENABLED
 Alarm text: EClologic AI01



ECLogic alarm setup page.
 When the ECLogic alarm is triggered then the alarm condition is present.
 The alarm is triggered from ECLogic.
 When the condition has been present for a period equal to or longer than the delay, and in case the alarm is enabled, the alarm is provoked.
 When the alarm is provoked, the signal selected will be activated and the action selected will be taken.
 The alarm is automatically acknowledged in case auto ack. is enabled.



2022-09-30-09:47:33

The alarm trigger is set up in the EClologic Builder/Linker using the addresses below.

29068	ECLogic Alarms 01..08	16 unsigned int	bitwise
-------	-----------------------	-----------------	---------

General purpose timers

General purpose timers enable you to trigger your own custom made timer. Via the ECllogic Builder/Linker the trigger for the timer to be set up. A total of 8 such timers are available.

ENcombi

ADMIN

ECllogic timers

Timer 1:	5.0 s
Timer 2:	5.0 s
Timer 3:	5.0 s
Timer 4:	5.0 s
Timer 5:	5.0 s
Timer 6:	5.0 s
Timer 7:	5.0 s
Timer 8:	5.0 s



ECllogic timer setup page.
The commands for starting the timers are set from ECllogic.
The timer elapsed status is available in modbus
and can be used as in ECllogic.

2022-10-11-14:52:37

The timer triggers is set up in the ECllogic builder/Linker using the addresses below:

29069	ECllogic Timers 01..08	16 unsigned int	bitwise
-------	------------------------	-----------------	---------

The output of the timers when they are elapsed are found on the addresses below:

31021	BITFIELD_22	16 unsigned int	ECllogic Timers elapsed 01..16
-------	-------------	-----------------	--------------------------------

Monitoring

The ECweb provides a high-level overview of the installation. Below is an example of the first page presented under the Monitoring tile.

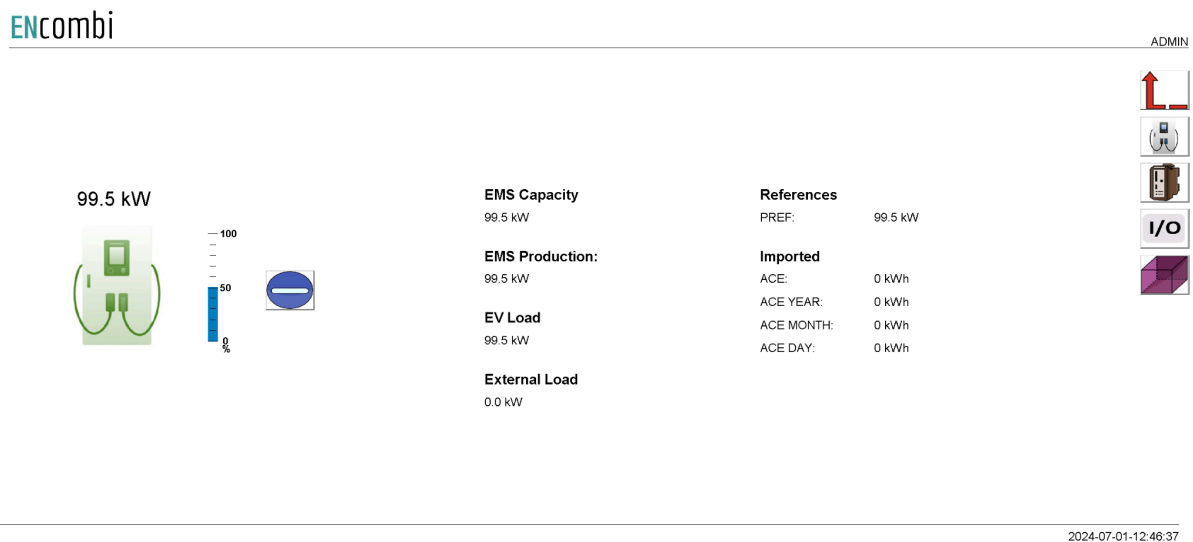

The current charging capacity, power production, EV charger power consumption, and the external load are shown in the left column. The right column shows the total power limit target and reference for the charging stations. The accumulated energy consumption is also shown here.

Clicking on the EMS or EV charger icon on the right hand side leads to a more detailed monitoring page. If enabled, the I/O button is also located on the right hand side. If enabled, the Simulation stimuli page is also shown here.

EMS

Clicking the EMS icon on the monitoring overview page leads to the data acquisition page of the EMS.

Identifiers:

EMS 1 
 MAC address: 026109611413
 Comm ID: 192.168.1.68, ID:1

Battery

SOC: 91.0 %
 SOH: 100.0 %
 SOE: 1000.0 kWh
 ODC: 100.0 kW
 OCC: 100.0 kW
 EVT1: 11354
 EVT2: 0

Mains control modes

Mains P ctrl: FIXED P PCC
 Mains Q ctrl: FIXED Q
 Mains Bat P ctrl: SYSTEM P
 Mains Bat Q ctrl: SYSTEM Q

Capacity

PV: 200.0 kW
 Genset: 0.0 kW
 Mains: 100.0 kW
 Battery: 250.0 kW

Active Power

PV: 100.0 kW
 Genset: 0.0 kW
 Mains: 50.0 kW
 Battery: 200.0 kW

Reactive Power

PV: 0.0 kW
 Genset: 0.0 kW
 Mains: 0.0 kW
 Battery: 0.0 kW

Battery charging limits

SOC max: 90.0 %
 SOC min: 10.0 %
 DG charging: DISABLED
 DG SOC start: 12.0 %
 DG SOC stop: 85.0 %
 Grid charging: ENABLED
 Mains SOC start: 12.0 %
 Mains SOC stop: 85.0 %
 PV charging: ENABLED
 PV SOC start: 15.0 %
 PV SOC stop: 80.0 %



Communication state: 

Communication enable: 

2024-02-28-13:05:11

This page shows all the data that is acquired from the EMS. The label can be changed by clicking the pencil icon in the top left corner. The communication status is shown in the bottom right corner of the page. A thumbs up means that the communication is online and a thumbs down means that there is some problem with the communication. The communication can be stopped manually pressing the “Communication enable” button. If the button shows a blue circle with a horizontal white bar the communication is enabled. If the white bar is vertical, the communication is disabled.

EV Chargers



Clicking the EV charger icon to the right leads to an overview of all installed EV charging stations.



EV Charger	Load	EV Charger	Load	EV Charger	Load	EV Charger	Load
EV 1	0.0 kW						



2024-06-13-15:45:36

Up to 32 EV charging stations can be displayed on this page together with the individual active power consumption of each station. Clicking the label of one station leads to the station's individual data acquisition page.

Identifiers:		AC		Gun #1:		
EV 1	424630	L1N:	230.9 V	STATE:	1	
Serial:	424630	L2N:	230.9 V	ACP:	N.A.	
Model:	Virtual	L3N:	230.9 V	Car ID:	A0B1C2D3	
Version:	1.00.0	L1L2:	400.0 V	Gun #2:		
Comm ID:	ID1	L2L3:	400.0 V	STATE:	1	
Production		L3L1:	400.0 V	ACP:	N.A.	
ACP:	100.0 KW	L1A:	130.0 A	Car ID:	A0B1C2D3	
ACQ:	0.0 KVAR	L2A:	130.0 A	Gun #3:		
ACS:	100.0 KVA	L3A:	130.0 A	STATE:	N.A.	
PF:	1.000	HZ:	50.00 Hz	ACP:	N.A.	
Status		DC		Car ID:	N.A.	
STATE:	2	DCA1:	142.8 A	Gun #4:		
EVT1:	0	DCU1:	700.0 V	STATE:	N.A.	
EVT2:	0	DCP1:	100.0 KW	ACP:	N.A.	
EVT3:	0			Car ID:	N.A.	
EVT4:	0					







Communication state: 
 Communication enable: 

2024-06-25-15:32:24

The data acquisition page shows all the data that is acquired from the EV charging station. The label of each EV charging station can be changed by clicking the pencil icon in the top left. In the bottom right of the page the communication status with the EV charging station is shown. A thumbs up means that the communication is online and a thumbs down means that there is some problem with the communication. The communication can be stopped manually pressing the “Communication enable” button. If the button shows a blue circle with a horizontal white bar the communication is enabled. If the white bar is vertical, the communication is disabled.

IO module data

Clicking the IO module button will lead to the below page where an overview of all the readings from the IO modules is provided. In case a reading is not supported or communication to the IO module is failing, the readings will be displayed as “N.A”.

IO modules	IO type	IO inputs	IO outputs	Communication state:	Communication enable:	
IO 1:	EX1600DD	0000 0000 0000 1000	N.A			
IO 2:	EX1609DD	0000 0000 0001 0000	0000 0000 0000 0000			
IO 3:	OFF	N.A	N.A	N.A	N.A	
IO 4:	OFF	N.A	N.A	N.A	N.A	

Simulation Stimuli

Clicking the Simulation button leads to the Simulation stimuli page. On this page a number of simulated cars charging at each station can be applied. The changes take effect by exiting the page via the “x” button in the top right corner.

ENcombi ADMIN

Stimuli

EV Charger	Cars
EV 1	<input type="text" value="0"/>

Simulation Stimuli page.

Here the number of cars charging at each station can be applied.

The change is applied by exiting the page with the "x" button.

2024-06-13-15:52:42

Service Tool

First page to be displayed after an initial welcome page when switching to the Service Tool application is the front page of ECweb.

ENcombi

Select your category

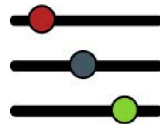
2020-07-26-10:57:51

Navigating around in the Service Tool is done in the same manner as in the ECev application.

In the lower center two menu tiles are available. These are from the left:

1. "Identifiers" gives access to an overview of the SW version installed as well as to the menu for switching between the applications.
2. "Settings" give access to the set up of various features.

In the following chapters the content of the two menu tiles are discussed in detail.

Identifiers

Under this tile overview of SW version installed and extras present in the ECev as well as to the menu for switching between the applications.

ENcombi

Company:					
Name:	Website:	Contact:	Support:	Cloud service:	
ENcombi	www.encombi.com	sales@encombi.com	support@encombi.com	www.encombi.online	
Product:					
Type:	Extras:	Project version:	Serial number:		
ECpvx Service Tool	-C-L-	1.00.0	202105040001		
Platform:					
Device type:	Device variant:	Chip type:	Rtos:	Version:	
WP240X	COM	SC24	V2.07 FULL	V23.9.63.1	
Identifiers:					
Serial number 1:	Serial number 2:	MAC address:			
14738AC71464B148	37648890F9A0D012	003056914973			

2021-09-20-14:22:53



On the right hand side there are one submenu for.

1. Application switch.

Application

Clicking the Application button leads to the page below. Here it can be selected which application is to be active.

ENcombi

Application		
Application:	ECPVX SERVICE TOOL	
 <div style="border: 1px solid black; padding: 5px; width: fit-content; margin: auto;"> <p style="text-align: center; margin: 0;">Application swap page. Here it is set up which application to run. When toggling between applications, the device is to be reboot. Any settings made in the ECPvx application will be lost in the process. Store a backup before leaving the ECPvx project if any settings are made that is to be restored when reverting to the ECPvx application. Browser needs refreshing when the device has rebooted.</p> </div>		

2021-09-20-14:23:22

The following applications are available.

1. ECev.
2. ECev Service Tool.
3. ECev Boot.

ECev is the default application and the one to use for the normal operation of the ECev. ECev Service Tool is a separate application that offers various tests and configuration features and the ECev Boot is a tool for updating both the ECev and the ECev Service Tool SW.

When toggling between applications the device is to be rebooted. Any settings made in the ECev application will be lost in the process. Make a backup before leaving the ECev application if any settings are made that are to be restored when reverting to the ECev application once again. The browser needs refreshing when the device is rebooted after switching the application.

Settings

Under this tile the setup of various features are found.

First page presented when clicking the Settings tile is the page below where COM2 configuration is set up.

ENcombi

COM2 port

Baudrate:	19200
Parity:	NO PARITY 1 STOP BIT
Timeout:	1.0 s
TX rate:	1.0 s
Slave ID:	1



COM2 Port setup page.
Baudrates supported are 9600, 19200, 38400 and 115200.

Power meter RTU communication is fixed on COM2.
Sensor and IO module RTU communication is optional on COM2.
In case none of these communications are enabled, COM2 is serving as a Modbus RTU slave.

Slave ID is only used in case COM2 is serving as a slave.



2022-03-11-15:08:56

Baud rates supported are:

- 9600, 19200, 38400 and 115200

Parity supported are:

- "Parity one stop bit", "No parity", "Even parity" and "Odd parity".

On the same menu level, a similar setup page for COM3 configuration is found. Clicking the up/down arrows will lead to it.

On the right hand side there are two submenus for.

1. Power meter configuration.
2. IO modules
3. Modbus Tester.
4. Client Trace.

Power meter configuration

Power meter configuration allows you to read and write the configurations of various power meters over Modbus. Clicking the Power meter button leads to the page below where a Pilot SPM32 power meter can be configured.

SPM32 config

Baudrate:	9600	
CT ratio:	1	
VT ratio:	1	
Conn mode:	3 Phase 4 Wire	
Modbus ID:	1	1

SPM32 setup page.
 Here a SPM32 power meter can be set up.
 It is fixed to use COM2.
 Port settings is setup at dedicated port setup page.
 Connect A(-) on the ECpv to RS485+ on the SPM32 and
 Connect B(+) on the ECpv to RS485- on the SPM32.
 Note that the SPM32 Modbus ID is set via the
 dipswitches on the back side.

2020-07-31-13:18:19

Clicking up/down buttons will navigate through all the meter power meter configurators supported. Currently the following are supported:

1. Pilot SPM32.
2. Pilot SPM33.

IO configuration

IO configuration allows you to read and write the configurations of IO modules over Modbus. Clicking the IO button leads to the page below where COM2 or COM3 can be selected.

IO modules

COM port:	COM2	
-----------	------	--

IO module setup page.
 IO module communication can either run Modbus RTU or Modbus TCP.
 Whether to use COM2, COM3 or TCP is selectable by parameter.
 Port settings is setup at dedicated port setup page.

2021-09-20-14:29:30

Afterwards clicking on the IO configuration button on the right hand side leads to the IO configuration page.

ENcombi

IO module comm.

Baudrate: 9600

Parity: EVEN PARITY

Modbus ID: -

Timeout: -

IO module search

Modbus ID: 1

Module: N.A

FW version: N.A

Overdigit IO module communication setup page.

After IO module is powered up, then press the PG button on the IO module for 3s until the green LED starts flashing. Now the IO module is in a temporary state having the Baudrate and Parity listed in the colored Active Column. Note that the COM port selected for IO module communication must be configured accordingly to complete the configuration successfully. In the update column the requested communication setup is made and Save button is pushed to write it to the IO module. Afterwards, press the PG button again to stop the green LED flashing and activate the communication setup just made.

The Timeout determines the delay for no communication being active before the IO module releases all its relays. Setting it to "0 x 10ms" means disabling the functionality and the IO module will keep the relays at there states in case of communication loss.

Search a Modbus ID to find module type and firmware version.

2022-02-07-14:32:39

It is possible to set up the Overdigit IO module with the tool.

After the IO module is powered up, then press the PG button on the IO module for 3s until the green LED starts flashing. Now the IO module is in a temporary state, having the Baudrate and Parity listed in the colored Active Column. Note that the COM port selected for IO module communication must be configured accordingly to complete the configuration successfully. In the update column the requested communication setup is made and the Save button is pushed to write it to the IO module. Afterwards, press the PG button again to stop the green LED flashing and activate the communication setup just made.



The Timeout determines the delay for no communication being active before the IO module releases all its relays. Setting it to "0 x 10ms" means disabling the functionality and the IO module will keep the relays at their states in case of communication loss.

AIO

When pressing the settings icon, it will lead to the following page.

ENcombi

EX04AIO config

Channel 1 type:	OFF	  <div style="border: 1px solid #ccc; padding: 5px; margin: 5px auto; width: 80%; font-size: 0.8em;"> <p>Overdigit AIO module communication setup page. Here an EX04AIO can be set up. It is optional which port to use. It is setup at dedicated COM page. Port settings is setup at dedicated port setup page.</p> <p>Setup input and output for all 4 channels. Modbus ID needs to be set in order to write configuration.</p> </div> 
Channel 1 source:	0-10V	
Channel 2 type:	OFF	
Channel 2 source:	0-10V	
Channel 3 type:	OFF	
Channel 3 source:	0-10V	
Channel 4 type:	OFF	
Channel 4 source:	0-10V	
Modbus ID:	-	

2022-02-07-14:34:29

From there it is possible to set up an EX04AIO module. From here it is selectable which channel to use for input and output. All 4 channels can be selected as off, input and output. It is also selectable which source the input or output should work with. The two options are 0-10 or 4-20mA. When the configuration is ready, the modbus ID must be set and after that it is possible to write the configuration to the module. An icon will show if the writing was successful or failed.

Toggle to the next page will lead to the set up of EX04AIS.

ENcombi

EX04AIS config

Channel 1 source:	OFF	  <div style="border: 1px solid #ccc; padding: 5px; margin: 5px auto; width: 80%; font-size: 0.8em;"> <p>Overdigit AIS module communication setup page. Here an EX04AIS can be set up. It is optional which port to use. It is setup at dedicated COM page. Port settings is setup at dedicated port setup page.</p> <p>Setup input for all 4 channels. Modbus ID needs to be set in order to write configuration.</p> </div> 
Channel 2 source:	OFF	
Channel 3 source:	OFF	
Channel 4 source:	OFF	
Modbus ID:	-	

2022-02-08-09:42:21

These are only inputs, so the only configuration is which source the channels should be. It can also be selected as OFF, which means the channel is deactivated.

Sensor Configuration

The Sensor configuration allows you to read and write the configurations of various sensors over Modbus. Clicking the Sensor button leads to the page below where it is set up whether the Sensor configuration is to use COM2 or COM3.

ENcombi

Sensors

COM port: COM2



Sensor setup page.
Sensor communication is running Modbus RTU only.
Whether to use COM2 or COM3 is selectable by parameter.
Port settings is setup at dedicated port setup page.





2022-03-11-15-07:41

Afterwards, clicking on the setup button on the right hand side leads to the Sensor configuration itself where the Sensor modules communication settings can be adjusted and the Sensor modules can be searched and identified.

ENcombi

SolSolare config

Baudrate:	N.A.				
Parity:	N.A.				
Modbus ID:	N.A.	60	 		
Serial:	N.A.				
FW main:	N.A.				
FW minor:	N.A.				



Soluzione Solare setup page.
Here the Soluzione Solare sensors can be set up.
Port settings are setup at dedicated port setup pages.
Connect A(-) on the ECpv to RS485+/B on the sensor and
Connect B(+) on the ECpv to RS485-/A on the sensor.



2022-03-11-15-08:02

Modbus Tester

Modbus Tester is a feature where the Service Tool acts as a Modbus RTU Master and communication with a Modbus RTU Slave can be tested. Clicking the Modbus Tester button leads to the page below where it is set up whether the Modbus Tester is to use COM2 or COM3.

Modbus tester

COM port: COM2



Modbus test page.
Here read and write commands can be tested.
The Modbus tester is for Modbus RTU only.
Whether to use COM2 or COM3 is selectable by parameter.
Port settings is setup at dedicated port setup page.



2020-07-26-11:17:56

Afterwards, clicking on the Modbus Tester button on the right hand side leads to the Modbus Tester itself where Modbus RTU read and write commands of various length and function codes can be transmitted and the response received is shown.

Read

Start ID:	Stop ID:	Control Fnc:	Control Fnc:	Control Fnc:	Address:	Length:
1	1	0x03	16BIT	SIGNED	0	1
N.A	N.A	N.A	N.A	N.A	1	N.A
N.A	N.A	N.A	N.A	N.A	N.A	
Register 1..2	Register 3..4	Register 5..6	Register 7..8	Register 9..10	Byte 01..20	

Write

Modbus ID:	Control Fnc:	Control Fnc:	Control Fnc:	Address:	Command:
1	0x06	16BIT	SIGNED	0	0
UNICAST	N.A				

2022-03-11-14:56:43



Client trace

Clicking the Client Trace button leads to the page below where trace of Modbus communication can be enabled/disabled. The Modbus Tester only shows the result/content of valid Modbus frames received. The Trace, on the other hand, provides information on any communication being detected on the RS485 line even if it is not perceived as valid Modbus frames.

ENcombi

Trace

Modbus: DISABLED

Trace setup page.
Enabling/disabling trace of various device client activities.
Trace is readable via device Telnet server.



2020-07-26-11:35:57

Trace is available via the built-in Telnet server. Clicking on the Telnet server button on the right hand side leads to the Telnet server setup.

Telnet server

On the page below the telnet server access is set up.



ENcombi

TELNET Server:

User0: telnet_user0

Password0: *****

Telnet: ENABLED

ADMIN



Telnet server setup page.
Credential is for device telnet server access.
Telnet is usable for tracing various device client activities.



2020-07-10-13:14:30

Use the PC application "Chiptool" to connect to the Telnet Server to follow activities such as the Modbus trace.

Boot

First page to be displayed after an initial welcome page when switching to the Boot application is the front page of ECweb.

ENcombi



Select your category



2021-02-02-13:42:34

Navigating around in the Service Tool is done in the same manner as in the ECev application.

In the lower center one menu tile is available:

1. "Identifiers" gives access to an overview of the SW version as well as to the menus for updating SW and switching between the applications.

In the following chapters the content of the menu tile is discussed in detail.

Identifiers

Under this tile overview of SW version installed and extras present in the ECev.

ENcombi

Company:

Name:	Website:	Contact:	Support:	Cloud service:
ENcombi	www.encombi.com	sales@encombi.com	support@encombi.com	www.encombi.online



Product:

Type:	Extras:	Project version:	Serial number:
ECpvx Boot	-C-L-	1.00.0	202105040001

Platform:

Device type:	Device variant:	Chip type:	Rtos:	Version:
WP240X	COM	SC24	V2.07 FULL	V23.9.63.1

Identifiers:

Serial number 1:	Serial number 2:	MAC address:
14738AC71464B148	37648890F9A0D012	003056914973

2021-09-20-14:36:07

On the right hand side there are submenus for.

1. SW update.
2. Application switch.

SW update

Clicking the SW update button leads to the page below. From here the ECev and the ECev Service Tool SW can be updated from a USB stick.

ENcombi



Device project update via USB.

- 1: Create an empty folder on your laptop named ECpvx_SW.
- 2: Download the SW file from the website.
- 3: Unzip the downloaded file.
- 4: Navigate to the SW version folder.
- 5: Copy the content of the SW version folder.
- 6: Paste the content to the ECpvx_SW folder.
- 7: Copy the ECpvx_SW folder to the root of a USB stick.
- 8: Insert USB stick into the device.
- 9: Click the search for SW button.
- 10: Wait for the process to complete.
- 11: If completed successfully then revert to the ECPVX application.



2021-09-20-14:47:23

Download the SW from the website and place it in a folder named "ECev_SW" in the root of a USB stick like shown below:

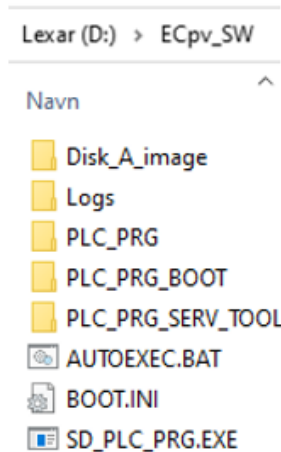

Then insert the USB stick into the ECev and press the binoculars button to start the SW update. When the SW update is completed successfully, then you can safely revert to the ECev application. If the SW is interrupted and it fails, then remain in the Boot application and try to update the SW once again. Do not return to the ECev application until the SW update is completed successfully.

Application

Clicking the Application button leads to the page below. Here it can be selected which application is to be active.

ENcombi

Application

Application: ECPVX BOOT



Application swap page.
Here it is set up which application to run.
When toggling between applications, the device is to be reboot. Any settings made in the ECPVX application will be lost in the process. Store a backup before leaving the ECPVX project if any settings are made that is to be restored when reverting to the ECPVX application.
Browser needs refreshing when the device has rebooted.

2021-09-20-14:48:01

The following applications are available.

1. ECev.
2. ECev Service Tool.
3. ECev Boot.

ECev is the default application and the one to use for the normal operation of the ECev. ECev Service Tool is a separate application that offers various tests and configuration

features and the ECev Boot is a tool for updating both the ECev and the ECev Service Tool SW.

When toggling between applications the device is to be rebooted. Any settings made in the ECev application will be lost in the process. Make a backup before leaving the ECev application if any settings are made that are to be restored when reverting to the ECev application once again. The browser needs refreshing when the device is rebooted after switching the application.