



ECpvX

User manual



<b>Document change log</b>	<b>5</b>
<b>Introduction</b>	<b>8</b>
<b>ECweb</b>	<b>10</b>
Connecting to ECweb with Internet Explorer or Pale Moon browser on PC/laptop	10
Connecting to ECweb using any other browser or mobile device	10
Troubleshooting	11
Navigating the ECweb	12
<b>Control</b>	<b>14</b>
IP configuration	14
Internal clock	14
NTP synchronization	14
Manual time adjustment	15
FTP client	15
FTP server	16
Automatic FTP transfer	16
ECpvX server access	16
ECpvX FTP server	17
ECpvX Telnet server	17
ECpvX web server (ECweb)	19
<b>Identifiers</b>	<b>20</b>
ECpvX information	20
Project details	20
Password scheme	21
Passwords	22
Permissions	23
License & Extras	24
Search online	24
Search on USB	24
Metrics	25
Backups	26
Application	27
<b>Settings</b>	<b>28</b>
RS485 COM ports	28
PV	30
Ratings	30
Measurements	30
Reference limits	32
Ramp rates	33
Ramp threshold	34
Tariff	34

Counters	36
Meter	37
Relay	37
CT settings	38
Frame settings	39
Inverter	40
RTU	40
TCP	41
Advanced Inverter command setup	43
SunSpec inverter command setup	44
Secondary inverter setup	44
Multiple inverter cluster setup	45
Inverter PID control	46
Battery	48
Ratings	48
Measurements	48
Reference limits	50
Ramp rates	51
Minimum battery load	51
Dispatch DG	52
Dispatch grid	52
PV charge	53
DG charge	54
Minimum DG load charge	55
Grid charge	55
Grid mode backup	56
Backup capacity	57
Genset mode backup	57
Backup capacity	58
DOD settings	58
Counters	58
Meter	59
Inverter	59
RTU	60
TCP	61
Advanced Inverter command setup	61
Commands	61
PCS mode handling	62
PCS PID control	63
BMS	64
RTU	64
TCP	65

HVAC	66
RTU	66
TCP	67
Genset	68
Measurements	68
References	70
Tariffs	71
Rated sizes	73
Counters	73
Meter	74
Genset management	75
Load dependent start/stop	76
Non-sync.	76
Sync SR.	77
Genset start/stop failures	78
Mains	79
Measurements	79
References PV	82
References Battery	83
API	84
Tariffs	84
Rated sizes	85
Counters	85
Meter	86
Grid management	87
Grid connect	88
Grid disconnect	89
Grid support	90
P(f)	90
U(Q)	91
Advanced grid support	92
Over Voltage	92
Under Frequency	92
Load	93
Load meter for control	94
Sensors	96
Modbus RTU Sensors	96
PV generating capacity	97
IO modules	99
Analogue input/output	100
Alarms	101
Genset low power	102

Mains low power	103
COM2 slave	103
COM3 slave	104
TCP slave	104
SOC minimum	105
SOC maximum	106
Cell voltage minimum	106
Cell voltage maximum	107
Fuel level alarm	107
Inverter production deviation alarm	108
Common master communication	108
Modbus Master comm. alarms	109
Overview	110
Nighttime	111
Simulation	112
Proprietary modbus pages	113
Monitoring	114
ECsync	115
Synchronization and deload	115
ECsync communication setup	115
RTU	116
TCP	117
<b>Logs</b>	<b>117</b>
Local logs with transmission via ftp	117
Log to MySQL database	119
<b>EClogic</b>	<b>120</b>
Builder	121
Example	122
Linker	123
Example continued	123
Overruling of Settings parameters	124
General Purpose Hysteresis	125
RRCR	126
AIO	128
Sensor	128
IO	129
Command timers	129
Charge scheduler	130
Command panel	131
General purpose alarms	131
General purpose timers	132
<b>Monitoring</b>	<b>133</b>

Command panel	134
Sensor data	135
IO module data	136
ECsync data	136
Simulation	137
PV	138
PV meter data	141
Inverter data	142
Genset	144
Genset meter data	144
Mains	145
Mains meter data	145
Spot price market data	145
Battery	147
Inverter data	148
BMS data	149
HVAC data	150
Load	151
<b>ECpvX stacking</b>	<b>154</b>
ECpvX slave	155
ECpvX master	155
Genset stacking	155
ECpv2 slave	156
ECpv2 Master	156
<b>Service Tool</b>	<b>157</b>
Identifiers	158
Application	158
Settings	160
Power meter configuration	160
IO configuration	161
AIO	163
Sensor Configuration	164
Modbus Tester	164
Client trace	166
Telnet server	166
<b>Boot</b>	<b>167</b>
Identifiers	168
SW update	168
Application	169

## Document change log

2021-10-04	First version
2022-02-08	Release of ECpvX 1.02.0
2022-03-14	Release of ECpvX 1.03.0
2022-04-06	Release of ECpvX 1.04.0
2022-07-05	Release of ECpvX 1.05.0
2022-07-19	Updated for ECpvX version 1.09.0
2022-09-30	Updated for ECpvX version 1.13.0
2022-10-10	Updated for ECpvX version 1.14.0
2022-10-31	Updated for ECpvX version 1.15.0
2022-11-09	Updated for ECpvX version 1.16.0
2022-11-21	Updated for ECpvX version 1.17.0
2022-11-22	Updated for ECpvX version 1.18.0
2022-12-15	Updated for ECpvX version 1.19.0
2022-02-06	Updated for ECpvX version 1.21.0
2023-03-24	Updated for ECpvX version 1.24.0
2023-04-16	Updated for ECpvX version 1.26.0
2023-05-09	Updated for ECpvX version 1.28.0
2023-05-17	Updated for ECpvX version 1.29.0
2023-06-21	Updated for ECpvX version 1.30.0
2023-08-31	Updated for ECpvX version 1.34.0
2023-09-18	Updated for ECpvX version 1.36.0
2023-09-21	Updated for ECpvX version 1.36.1
2023-10-02	Updated for ECpvX version 1.37.0
2023-10-25	Updated for ECpvX version 1.37.3
2023-12-05	Updated for ECpvX version 1.38.0

2023-12-15	Updated for ECpvX version 1.39.0
2024-01-07	Updated for ECpvX version 1.40.0
2024-01-16	Updated for ECpvX version 1.41.0
2024-02-20	Updated for ECpvX version 1.44.0
2024-03-12	Updated for ECpvX version 1.45.0
2024-04-03	Updated for ECpvX version 1.47.0
2024-04-10	Updated for ECpvX version 1.49.0
2024-04-16	Updated for ECpvX version 1.50.0
2024-04-18	Updated for ECpvX version 1.51.0
2024-04-30	Updated for ECpvX version 1.52.0
2024-05-26	Updated for ECpvX version 1.56.0
2024-08-08	Updated for ECpvX version 1.59.1
2024-08-21	Updated for ECpvX version 1.61.0



## Introduction

The ECpvX from ENcombi is capable of controlling the production of Battery inverters combined with PV inverters synchronized to battery, grid and/or gensets. The ECpvX is agnostic in the sense that it integrates with Battery inverter, PV inverters, gensets, meteorological sensors and power meters independent of vendor and model.

The production of Battery inverters and PV inverters are controlled seamlessly via a communication interface to the inverters. This interface can be either via Modbus RTU running on serial RS485 line or via Modbus TCP running on ethernet dependent on the inverter vendor and model used.

The same can be said of the interfaces to genset controller and power meters, these can be interfaced to also via Modbus RTU running on serial RS485 line or via Modbus TCP running on ethernet dependent on the vendors and models used.

Meteorological sensors are interfaced via Modbus RTU running on serial RS485 line only.

All interfaces for both Battery inverters, PV inverters, gensets, power sensing meters and meteorological sensors are pre-embedded and are enabled merely by parameter setting.

All configuration and real time monitoring of the ECpvX is done by connecting with a standard web browser to its built-in webserver (ECweb). Comprehensive help texts guide you through the configuration setup. ECweb can run on any device featuring a web browser. Use for instance a panel PC as a local HMI. A laptop or portable device which will give you monitoring and control capabilities even from remote if connectivity to the ECpvX is in place.

It is not mandatory for the control and balancing of the Battery, PV, genset and Mains part to work to have HMI or laptop connected to ECweb. It is required for commissioning of the ECpvX only.

Besides doing the control and balancing of the Battery, PV, genset and Mains the ECpvX is also acting as a datalogger. The ECpvX can make local file loggings on SD card or USB memory stick. These logs can be sent to the customer ftp server.

Furthermore the ECpvX can push data to a MySQL server hosted either by ENcombi with ENcombi front-end for data visualization (ECcloud) or customers can choose to push data to their own database and make use of their own data visualization tool.

Data logging functionality and connectivity to the internet is not mandatory for the control and balancing of the Battery, PV, genset and Mains part to work.

Below schematics are examples of how ECpvX are fitted into and interconnected to its surrounding environment.

## Modbus RTU inverters

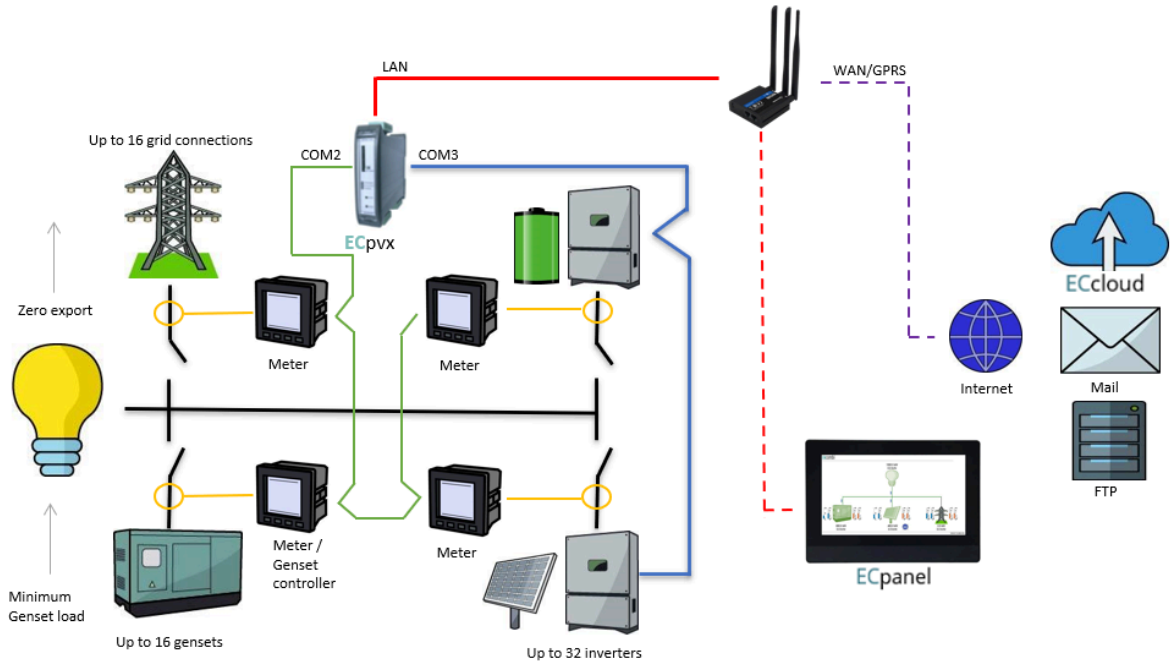

## Modbus TCP inverters

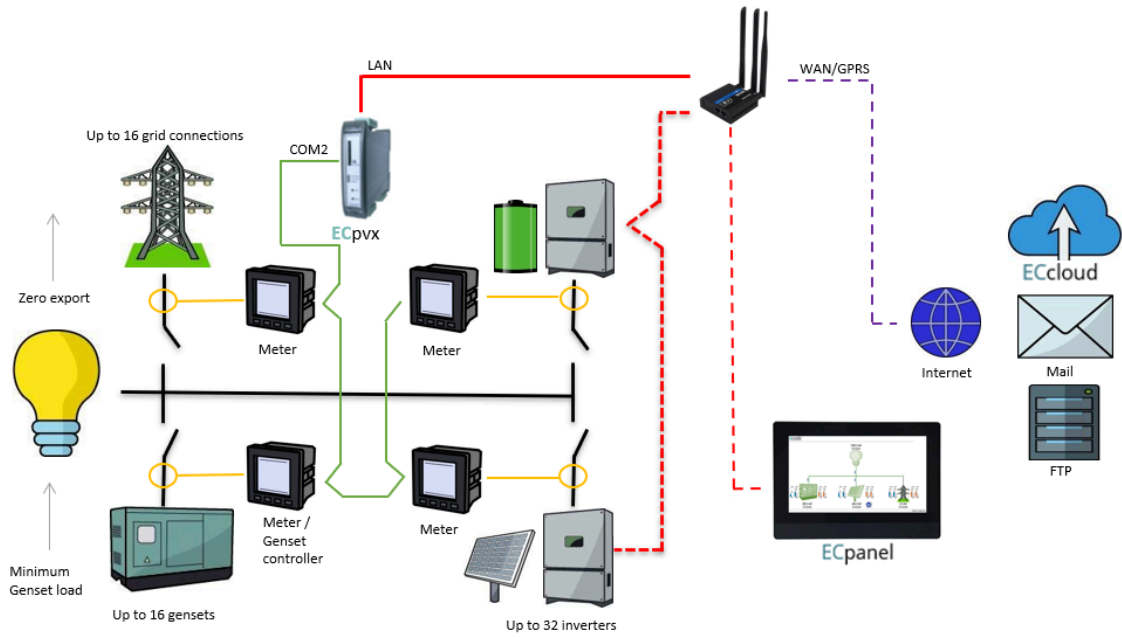

## ECweb

ECweb is the built-in webserver of the ECpvX. All configuration and real time monitoring of the ECpv2 is done via ECweb. Connection to ECweb is done with a standard web browser

Using a laptop/PC and Internet Explorer browser running on Java is the best option for connecting to ECweb. Other browsers and mobile devices can be used as well.

### Connecting to ECweb with Internet Explorer or Pale Moon browser on PC/laptop

Java from oracle must be installed on PC/laptop. Java can be downloaded from the link below. Note that either the Internet Explorer or the Pale Moon browser must be used for the download.

[Java download](#)

1: Type in IP address of the ECpvX in the browser command line.

Default IP address is:

192.168.1.101.

2: Type in login credentials when prompted.

Default login credentials are:

user: web\_user0

password: web\_password0

3: Accept/Ignore all warnings populated.

4: If tiles on the front page are out of order, click on the page and they will fall into place. If any icons are missing on the tiles, restart the browser and start over.

### Connecting to ECweb using any other browser or mobile device

For all other browsers on PC/laptop or from any browser on mobile devices.

1: Type in IP address/webvisu.html in the browser command line.

Default IP address is:

192.168.1.101.

2: Type in login credentials when prompted.

Default login credentials are:

user: web\_user0

password: web\_password0

## Troubleshooting

If connection can't be established verify that:

1. ECpvX is powered up and running. ECpvX must have 24VDC (+/- 15%) supply voltage. The green Power and the green Run LEDs in the front of the ECpvX must both be illuminated. Note that a too low supply voltage can result in a situation where sufficient voltage is present to power up the ECpvX but not to run the program. In this case the Power LED is illuminated but the Run LED. When powering up the ECpvX the Power LED will light up first and the Run LED will come approximately 30s after when ECpvX is initialized and the program is up and running.
2. Your laptop must be on the same subnet as the ECpvX. Even though you have an ethernet cable going directly from your laptop to the ECpvX you still need to make sure that your laptop is provided with a suitable IP address. In the case where the default IP address of the ECpvX 192.168.1.101 is kept a suitable IP address for your laptop would be 192.168.1.x, where x is a number in the range [2;249] excluding "101" as this is used by the ECpvX itself.
3. Once the IP of your laptop is in place you must be able to ping the ECpvX. This can be done by opening a command prompt and writing the command "ping xxx.yyy.zzz.www" where xxx.yyy.zzz.www is the IP address of the ECpvX as shown below. First when the ECpvX replies to the command it is verified that your laptop and the ECpvX can see each other on the network and you can connect to ECweb using the browser as described above.

```
C:\Users\Claus>ping 192.168.1.101

Pinging 192.168.1.101 with 32 bytes of data:
Reply from 192.168.1.101: bytes=32 time=15ms TTL=255
Reply from 192.168.1.101: bytes=32 time=25ms TTL=255
Reply from 192.168.1.101: bytes=32 time=1ms TTL=255
Reply from 192.168.1.101: bytes=32 time=11ms TTL=255

Ping statistics for 192.168.1.101:
    Packets: Sent = 4, Received = 4, Lost = 0 (0% loss),
    Approximate round trip times in milli-seconds:
        Minimum = 1ms, Maximum = 25ms, Average = 13ms
```

## Navigating the ECweb

The first page to be displayed after an initial welcome page when connection is established is the front page of ECweb.

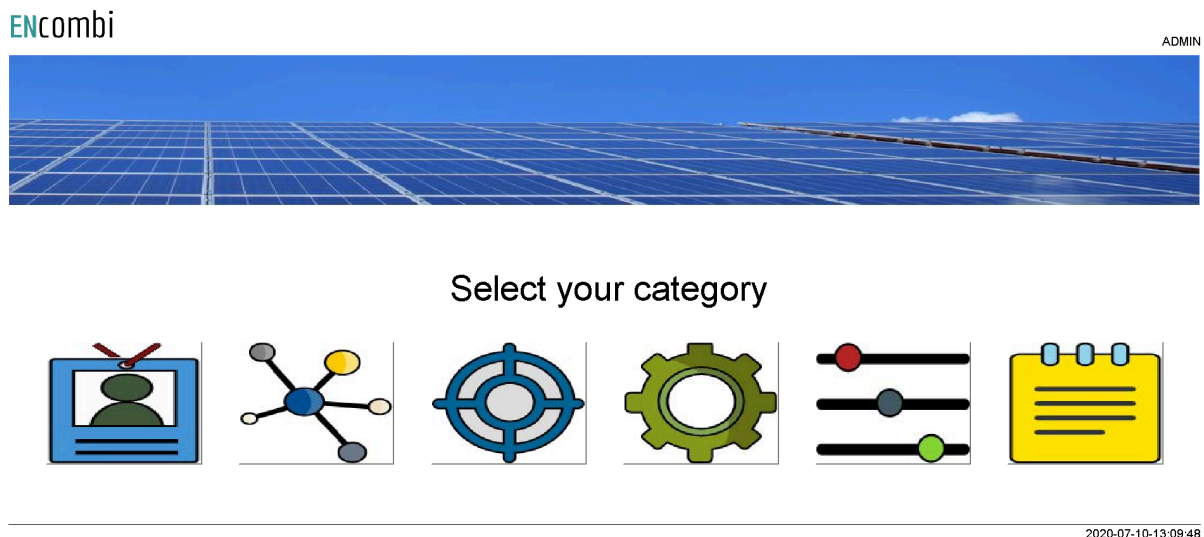

Whenever navigating around the ECweb you can always return to this page by clicking the ENcombi logo in the upper left corner.

In the upper right corner you can see the current access login level. Find more information about this in the chapter revolving password scheme.

In the lower left corner ECpvX will display any info and warning messages it wants to communicate to the user. Some messages will clear themselves automatically. Others demand user action to be acknowledged first. In that case a dedicated button with a garbage can symbol will be presented alongside the messages. Furthermore when changing certain settings etc. a reboot of the ECpvX is required before the changes take effect. This will be communicated in the message as well and a dedicated button with refresh symbol will be presented alongside with the messages.

In the lower right corner is the internal clock of the ECpvX displayed.

In the lower center a total of six menu tiles are available. These are from the left:

1. "Identifiers" gives access to overview of SW version installed and extras present in the ECpvX as well as set up of project details (name, location etc.), password scheme etc.
2. "EClogic" provides the possibility of making project specific logical expressions when required. That could be for linking physical digital inputs applied on power meters to the position of breakers or similar. Also here RRCR can be set up

providing the option of a superior control system to give power references for the ECpvX to follow.

3. "Monitoring" provides a high level overview of the installation as well as detailed information about each individual inverter and power meter.
4. "Control" gives access to set up of ECpvX controller related parameters such as IP configuration, Internal clock handling etc.
5. "Settings" give access to setup of site specific parameters such as number and ratings of genset, grid connections, and inverters, which power meters are used, power and reactive control schemes etc.
6. "Logs" give access to setup of log specific parameters.

In the following chapters the content of the six menu tiles are discussed in detail.

## Control

Under this tile set up of ECpvX controller related parameters for IP configuration, Internal clock handling etc. are found.

### IP configuration

First page presented when clicking the Control tile is the page below where IP configuration is set up and connectivity to the gateway can be tested.

ENcombi ADMIN

**IP config**

IP address: 192.168.1.101

Netmask: 255.255.255.0

Gateway: 192.168.1.1

**DNS config**

DNS server 01: 89.249.14.50

DNS server 02: 89.249.14.54

IP setup page.  
Connectivity to gateway and DNS server can be tested.

Test: 192.168.1.1

2020-07-10-13:10:20

On the right hand side there are four submenus for.

1. Internal clock.
2. FTP client.
3. ECpvX server access.

### Internal clock

The internal clock can be synchronized against an NTP server as well as be set manually.

#### NTP synchronization

First page presented when clicking the clock button is the page below where NTP synchronization can be set up and connectivity to an NTP server and its functionality can be tested.

### NTP config

NTP address 1: dk.pool.ntp.org  
 NTP address 2: 81.88.24.155  
 UTC: 1  
 Daylight: EUROPEAN  
 NTP sync hour: 0:00  
 NTP: ENABLED



NTP setup page.  
 Connectivity to an NTP server can be tested.

Test:

188.40.88.13



2020-07-10-13:10:47

On the same submenu level the manual time adjustment of the internal clock is found. Clicking the up/down arrows will lead to it.

### Manual time adjustment

On the page below the internal clock can be set manually. The time of the PC connected is presented and can be used to set the ECpvX clock against.

### Manual config

PC time: 2020-07-10-13:11:14

PLC time:

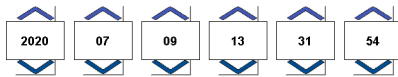

Manual device clock adjustment.  
 PC time shown for reference.

2020-07-10-13:11:12

### FTP client

The ECpvX has an FTP client and can transfer logs to an FTP server. It can be set up to do so automatically in case of an event/alarm occurring as well as transferring the summary and production logs when completed. This is discussed in detail in the Logs chapter later in this document. The customer/installer must make use of their own FTP server.



## FTP server

First page presented when clicking the FTP button is the page below where the FTP server details are set up. Connectivity to FTP server as well as functionality can be tested.

On the same submenu level the set up of automatic FTP transfer is found. Clicking the up/down arrows will lead to it.

## Automatic FTP transfer

On the page below the automatic transfer of files is set up.

## ECpvX server access

The ECpvX features three servers:

1. FTP server.
2. Telnet server.
3. Web server (ECweb).

### ECpvX FTP server

First page presented when clicking the server button is the page below where the FTP server access details are set up.

Two sets of credentials exist.

1. Credential set0 will provide access to the PLC\_PRG folder on the SD-card.
2. Credential set1 will provide access to the Logs folder on the SD-card.

FTP server access in general can furthermore be enabled/disabled.

The screenshot displays the ENcombi web interface for FTP server configuration. The top left shows the 'ENcombi' logo, and the top right has an 'ADMIN' label. The main content area is titled 'FTP Server:' and contains the following fields:

- User0: ftp\_user0
- Password0: \*\*\*\*\*
- User1: ftp\_user1
- Password1: \*\*\*\*\*
- FTP: ENABLED

In the center, there is a message box with the text: 'FTP server setup page. Credential0 is for remote SW update via FTP. Credential1 is for reading out logs via FTP.' To the left of this box are icons for editing (a pencil) and navigation (up/down arrows). To the right is an 'ADMIN' button with a red arrow icon. At the bottom right of the page, the timestamp '2020-07-10-13:14:07' is visible.

On the same submenu level the set up of telnet server access is found. Clicking the up/down arrows will lead to it.

### ECpvX Telnet server

On the below page the telnet server access is set up. It is normally not used as it is intended for debug purposes only by tracing various ECpvX client activities. Telnet server access in general can furthermore be enabled/disabled.

TELNET Server:

User0: telnet\_user0  
Password0: \*\*\*\*\*  
Telnet: ENABLED



Telnet server setup page.  
Credential is for device telnet server access.  
Telnet is usable for tracing various device client activities.

On the same submenu level the set up of web server access is found. Clicking the up/down arrows will lead to it.

## ECpvX web server (ECweb)

On the page below the web server access is set up.

The HTTP port can be changed. This can be useful if to access ECpvX from outside the LAN using port forwarding and multiple ECpvX's or other devices also featuring a web server are connected to the LAN as well.

#### WEB Server:

User0: web\_user0

Password0: \*\*\*\*\*

HTTP port: 80



WEB server setup page.  
Credential is for device WEB server access.  
The HTTP port can be changed which can be useful if to setup  
port forwarding in a router/gateway to the device.

## Identifiers

Under this tile overview of SW version installed and extras present in the ECpvX as well as set up of project details (name, location etc.), password scheme etc. are found.

## ECpvX information

First page presented when clicking the Identifiers is the below page where various details about the ECpvX such as extras available, SW version, serial number etc. Also the MAC address can be found which is to be used when registering the ECpvX in ECcloud.

ENcombi
ADMIN

---

<b>Company:</b>					
<b>Name:</b>	<b>Website:</b>	<b>Contact:</b>	<b>Support:</b>	<b>Cloud service:</b>	
ENcombi	www.encombi.com	sales@encombi.com	support@encombi.com	www.encombi.online	
<b>Product:</b>					
<b>Type:</b>	<b>Extras:</b>	<b>Project version:</b>	<b>Serial number:</b>		
ECpvx	-C-L-	1.00.0	202105040001		
<b>Platform:</b>					
<b>Device type:</b>	<b>Device variant:</b>	<b>Chip type:</b>	<b>Rtos:</b>	<b>Version:</b>	
WP240X	COM	SC24	V2.07 FULL	V23.9.63.1	
<b>Identifiers:</b>					
<b>Serial number 1:</b>	<b>Serial number 2:</b>	<b>MAC address:</b>			
14738AC71464B148	37648890F9A0D012	003056914973			

2021-08-18-11:46:22

On the right hand side there are five submenus for.

1. Project details.
2. Password scheme.
3. Extras.
4. Metrics.
5. Backups.
6. Application

## Project details

Clicking the location button leads to the below page where project details such as site name and location can be entered. Site name as well as location information is used when registering ECpvX in ECcloud as well as for data visualization in ECcloud after registration.

## Project details:

Site: Holstebrovej 75  
 Customer: Sterregaards  
 Installer: Claes  
 Install date: 2018-03-04



Site details setup page.  
 The site name will be used by the device as the  
 "from-alias" when sending out Emails.

## Location details:

Country: Denmark  
 Region: Midtjylland  
 City: Viborg  
 Latitude: 56.4483  
 Longitude: 9.3786

2020-07-10-13:19:03

## Password scheme

Clicking the log-in button leads to the below page where the password scheme can be enabled/disabled.

## Passw. scheme:

Timeout: 180 s  
 Scheme: DISABLED  
 ECpanel  
 Show passw: DISABLED



## Password editing scheme setup page.

The password editing scheme can be enabled/disabled by the administrator.  
 Level required for editing other settings, start/stop of plant etc. can be configured on dedicated permission setup pages.  
 If password scheme is disabled, all users logged into web server will have administrator rights.  
 Default passwords:  
 Administrator: Password0.  
 Service: Password1.  
 Operator: Password2.  
 The display of the ECpanel password in clear text on the ECpanel can be enabled.

2021-03-31-08:37:58

The password scheme holds four access levels:

1. Administrator.
2. Service.
3. Operator.
4. Viewer.

Required access levels of the various functionalities can be tailored by the customer as shown later. Whenever an attempt is made to alter/activate anything which is not allowed with the current access level, ECpvX will discard the command and populate a message text informing which access level is required to apply the command.

Viewer level is obtained just by logging on to ECweb.

When to change the access level the upper right text string informing about the current access level is to be clicked. Doing that leads to the below log-in page.

When logging in the requested access level and associated password is typed in. When the correct password is typed in the padlock will open. Hereafter the log-in button must be clicked. That will give the selected access level and take you back to the previous page.

When logging out just click the log-out button. The ECpvX will log out automatically when no editing occurs within the timeout period. Users will be degraded to Viewer level and must log in again as described above to regain the required access level.

When the password scheme is disabled as per default the user will have administrator rights.

Only an administrator can disable the password scheme.

Besides the enabling of the password scheme for ECweb itself, there is a setting for enabling visualization of the ECpanel password in clear text on the ECpanel itself. When disabled the ECpanel password is hidden on the ECpanel.

On the same submenu level the set up pages for Operator, Service and Administrator level passwords are found. Clicking the up/down arrows will lead to them.

## Passwords

Operator access or high is required for changing the Operator password.

Service access or high is required for changing the Service password.

Administrator access is required for changing the Administrator password.

three dedicated menus exist for changing the passwords. Below example for changing Operator password.

Operator

Password: \*\*\*\*\*



Operator password setup page.  
At least operator level login required  
for changing operator password.

On the same submenu level the set up pages for tailoring access level required for executing various commands are found. Clicking the up/down arrows will lead to them.

## Permissions

The various access levels required are set as below example.

### Log

Log setup: SERVICE

Log deletes: SERVICE

MySQL setup: SERVICE

MySQL data: SERVICE

MySQL deletes: SERVICE

### Settings

Settings: SERVICE

Counters: SERVICE

EClogic ADMIN



Permissions setup page.  
Setup password level required  
for various actions.  
Admin level login required for that.

Only an administrator can change the access level required for the various functionalities.



## License & Extras

Clicking the extras button leads to the page below where the list of available extras are displayed alongside with which of them are present in the ECpvX. Activation of License as well as upgrading with new Extras are done from here.

The screenshot shows the ENcombi interface for license and extras management. At the top left is the ENcombi logo, and at the top right is an 'ADMIN' link. Below the logo, the word 'Extras:' is followed by a list of extras, each with a yellow padlock icon and a status indicator (a small downward arrow). The extras listed are:

- A: Acquisition only
- C: Cloud service
- C TRIAL: Cloud service free trial
- H: Hybrid as a Service
- L: PV/genset plants, unlimitation PV capacity
- M: PV/genset plants, 500kW PV capacity limitation
- S: PV/genset plants, 100kW PV capacity limitation

In the center of the page, there is a white box with a black border containing the following text:

License and extras page.  
 Contact dealer for purchase of license and extras.  
 When purchased, the license or extras can be fetched  
 by the device either online or from a USB stick.  
 If online, the device must have access to the internet.  
 If from USB stick, goto [www.encombi.online](http://www.encombi.online) to download license.

To the right of this box are two binocular icons. The top one is labeled 'Search online:' and the bottom one is labeled 'Search on USB:'. In the top right corner of the interface, there is a red arrow icon pointing upwards.

At the bottom right of the page, the date and time '2020-07-10-13:24:28' are displayed.

After purchase of License or any additional Extra(s) the ECpvX is upgraded in one of the following ways.

### Search online

The ECpvX will have to be connected to the internet for this approach. Click the binoculars button for "Search online". When successfully completed the ECpvX will request a reboot.

### Search on USB

The License and Extras for the specific ECpvX are to be downloaded from ECcloud on [www.encombi.online](http://www.encombi.online) and put on the root directory on a USB stick. Insert the USB stick in the USB port on the ECpvX and click the binoculars button for "Search on USB". The ECpvX will check the USB stick for the upgrade. When successfully completed the ECpvX will request a reboot.

## Metrics

Clicking the metrics button leads to the below page where the metrics to use by ECpvX can be set up. The ECpvX will use the selected metrics for various displays on ECweb as well as in ECcloud.

**Settings**

Currency: Euro

Volume: liter

Mass: kg



Metrics setup page.  
Selected units will be used for  
various associated counters and derivatives.

## Backups

Clicking the Backup button leads to the page below where the backups supported by ECpvX are managed. The ECpvX provides two backups.

1. Settings.
2. Counters.

Both types can be:

1. Generated and stored locally on internal memory of ECpvX.
2. Loaded into ECpvX project from internal memory of ECpvX.
3. Copied from internal memory of ECpvX to ENcombi cloud for safe storage.
4. Read from ENcombi cloud to internal memory of ECpvX.
5. Generated and stored on USB-stick.
6. Loaded into ECpvX project from USB-stick.

When reading backups from the cloud it will overwrite any existing backup already present on the internal memory of the ECpvX. The presents of and date of origin of the backups on internal memory are displayed.

By default when reading backups from ENcombi cloud, the ECpvX will read backups generated by itself. If to clone an ECpvX this can be done by typing in the MAC address of the ECpvX you request to clone. Doing this ECpvX will read backups generated by that ECpvX instead.

ADMIN

Backup	Date	Action
Settings	2020-06-06-10:41:45	
Counters	N.A.	
MAC address:	0030569108A2	

Device backup page.  
Following backups can be made:

- 1: Settings backup.
- 2: Counter backup.

The backups are saved and loaded locally on/from the device.  
One backup for each function exist only.  
Saving a new backup will overwrite any existing backup.

Backups can also be saved and read in/from cloud service.  
One backup for each function per device can be saved only.  
Reading a backup from cloud service,  
will overwrite any existing local backup.

Furthermore backups can be saved on and loaded  
from USB memory stick.

To clone a device, backups created from other devices  
can be read from the cloud and loaded.  
To do so, the MAC address of the device to clone from  
must be typed in. The refresh button resets to the  
MAC address of the device itself.

2020-07-10-13:25:29

## Application

Clicking the Application button leads to the page below. Here it can be selected which application is to be active.

ENcombi

ADMIN

Application

Application: ECPVX

Application swap page.  
 Here it is set up which application to run.  
 When toggling between applications, the device is to be reboot. Any settings made in the ECpvx application will be lost in the process. Store a backup before leaving the ECpvx project if any settings are made that is to be restored when reverting to the ECpvx application. Browser needs refreshing when the device has rebooted.

2021-08-18-11:50:05

The following applications are available.

1. ECpvX.
2. ECpvX Service Tool.
3. ECpvX Boot

ECpvX is the default application and the one to use for the normal operation of the ECpvX. ECpvX Service Tool is a separate application that offers various tests and configuration features and the ECpvX Boot is a tool for updating both the ECpvX and the ECpvX Service Tool SW. The ECpvX Service Tool and the ECpvX Boot are treated in separate chapters.

When toggling between applications the device is to be rebooted. Any settings made in the ECpvX application will be lost in the process. Make a backup before leaving the ECpvX application if any settings are made that are to be restored when reverting to the ECpvX application once again. The browser needs refreshing when the device is rebooted after switching the application.

## Settings

Under this tile the setup of site specific parameters such as number and ratings of genset, grid connections, and inverters, which power meters are used, power and reactive control schemes etc. are found.

### RS485 COM ports

The ECpvX features two RS485 COM ports which are referred to as COM2 and COM3.

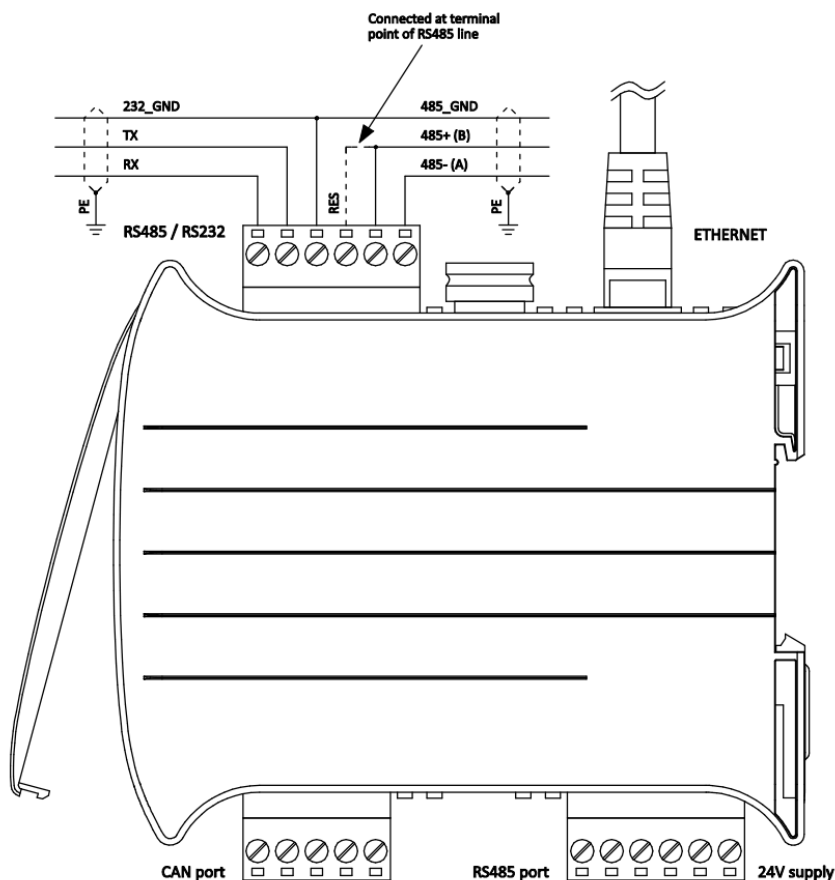

COM2 is the one found next to the power supply and COM3 is the one found next to the ethernet port.

- COM2 is reserved for interfacing to power meters and/or meteorological sensors.  
In case none of this is enabled, COM2 is acting as a slave port.
- COM3 is reserved for interfacing to inverters and/or meteorological sensors.  
In case none of this is enabled, COM3 is acting as a slave port.

First page presented when clicking the Settings tile is the page below where COM2 configuration is set up.

## COM2 port

Baudrate:	19200
Parity:	NO PARITY 1 STOP BIT
Timeout:	0.3 s
TX rate:	1.0 s
Slave ID:	1



COM2 Port setup page.  
Baudrates supported are 9600, 19200, 38400 and 115200.  
Power meter RTU communication is fixed on COM2.  
Sensor and IO module RTU communication is optional on COM2.  
In case none of these communications are enabled, COM2 is serving as a Modbus RTU slave.  
Slave ID is only used in case COM2 is serving as a slave.



2023-05-17-12:57:34

Baud rates supported are:

- 9600, 19200, 38400 and 115200

Parity supported are:

- "Parity one stop bit", "No parity", "Even parity" and "Odd parity".

When a COM2 port is acting as a master, the transmit rate can be used to control the rate at which the ECpvX transmits to the slaves.

The Slave ID is only used when a COM2 port is acting as a slave.

On the same menu level a similar setup page for COM3 configuration is found. Clicking the up/down arrows will lead to it.

On the right hand side there are fourteen submenus for.

1. PV related parameters.
2. Battery related parameters.
3. Genset related parameters.
4. Mains related parameters.
5. Sensor related parameters.
6. Load meter related parameters
7. IO module related parameters.
8. Alarm related parameters.
9. Overview.
10. Night time.
11. Simulation.
12. Modbus slave profiles.
13. Monitoring.

## 14. ECsync cabinet parameters

### PV

#### Ratings

Clicking the PV button leads to the below page where the rated values of the PV installation are set up.

**ENcombi** ADMIN

Rated	
Inverter S:	100.0 kVA
Inverter Q:	100.0 kVAr
Panel P:	150.0 kW
DC PV:	30.0 %

PV capacity setup page.  
 S and Q refers to installed inverter capacity.  
 P refers to installed PV panel capacity.  
 DC PV refers to how big a fraction of the installed PV capacity that is DC coupled.

2023-03-24-14:39:05

The S and Q refer to the total installed PV inverter capacity whereas the Panel P refers to the total installed PV panel capacity, that is both AC and DC coupled. The PV DC percentage refers to how big a part of the total installed Panel capacity that is DC coupled to the BESS.

#### Measurements

On the same submenu level the setup page for PV sensing methods are found. Clicking the up/down arrows will lead to it.

**ENcombi** ADMIN

Measurement	
Sensing method:	SUM ALL PHASES
kW Origin:	PV METER
kWh Origin:	ECPVX

PV measurement setup page.  
 Sensing method determines if to base reference on the sum of all phases or 3 x sensing values.  
 AC origin determines from which source the PV production arises.  
 kWh origin determines from which source the genset energy production arises.

2022-09-30-09:27:18

Sensing method determines what power readings to base the calculated references upon. Two options are available.

1. Sum all phases.
2. 3 x sensing.

#### *Sum all phases*

The control will work on the total loading of all phases.

#### *3 x sensing*

Only one CT is installed, sensing the production on one phase only. The phase production measured is representative for the production on the other two phases. The ECpvX will multiply the production sensed with three in order to get the total production.

kW origin determines from where to retrieve/calculate the PV power production. Supported methods are:

1. PV meter.
2. Inverter acquisition.
3. Inverter master control.
4. Modbus page 03.
5. Mains reading.

#### *PV meter*

Up to 16 power meters for sensing PV production can be installed. ECpvX will summarize the contributions from each of the meters into one common total for the PV power being produced. One meter is required for each cluster of inverters having a common point of coupling to the AC busbar.

#### *Inverter acquisition*

The ECpvX can also take the power contribution of the individual inverters directly from their own power measurements via the inverter communication. This approach should be carefully considered as loop time of getting all the individual contributions increases with the number of inverters (when interfacing to them via Modbus RTU) thereby introducing latency in the controls.

#### *Inverter master control*

Some inverter systems have a superior controller sitting on top acting as the point of interface from a superior controller such as the ECpvX. Examples hereof can be the Inverter Manager from SMA or Smartlogger from Huawei. These master controllers typically offer a summarized production of all the below inverter contributions on their own which the ECpvX can use directly. Again the loop time needs to be considered when using this method.

#### *Modbus page 03*



This will have ECpvX use the PV power data written from a superior controller/SCADA to the ECpvX proprietary modbus map page 3.

#### *Mains reading*

This will have ECpvX use the Mains power readings as an expression for the PV production as well. This can be used in an On-grid PV plant without any site load being present.

kWh origin determines from where to retrieve/calculate the PV energy production. Supported methods are:

1. ECpvX.
2. Power meters

#### *ECpvX*

Based on the kW measured, the ECpvX integrates energy counters itself.

#### *Power meters*

The ECpvX will read the total energy counter from the power meters and summarize those.

ECpvX will, based on this, derive daily, monthly and yearly energy counters.

The meter used must provide either the total energy counter or the total energy export counter in order to make use of this approach. Consult the Modbus master documentation on ENcombi website for detailed information about what data is read from the various meter models.

<http://www.encombi.com/products/ECpvX/>

Note that all counters derived from energy counters remain linked to the ECpvX energy counters still.

#### *Reference limits*

On the same submenu level the setup page for PV reference limits are found. Clicking the up/down arrows will lead to it.

### Reference limits

Priority:	OFF
Mains lim:	100.0 %
DG lim:	100.0 %
Cosphi cap:	0.600 C
Cosphi ind:	0.600 I
Cosphi lim:	DISABLED



**PV reference limits setup page.**  
 Priority setting determines whether to prioritise P or Q reference over the other in case exceeding rated S inverter capacity.

Max dispatch limits can be set for parallel operation to both grid and gensets respectively. In case the reference is exceeding, the device will limit the P reference.

Cosphi cap and Cosphi ind outlines operating range of the inverters. In case enabled and reference exceeding, the device will limit the Q reference.



2022-09-30-09:28:00

Priority setting determines whether to prioritize P or Q reference over the other in case exceeding rated S inverter capacity.

Maximum power dispatch limits can be set for grid and genset operation respectively. In case the reference calculated by the control schemes exceeds the limits, then the reference will be truncated to the limits.

Cosphi cap and Cosphi ind outline the operating range of the inverters. In case enabled and reference exceeds the outlined range, the ECpvX will limit the Q reference.

### Ramp rates

On the same submenu level the setup page for PV ramp rates are found. Clicking the up/down arrows will lead to it.

### Island

P ramp up:	2.0 %
P ramp down:	2.0 %
Q ramp up:	2.0 %
Q ramp down:	2.0 %



**PV ramp rate setup page.**  
 Ramp P and Ramp Q down determines the rate of change of the P and Q references respectively.  
 In case PV paralleling with gensets only and these are in reverse power or overload state the ramps will be bypassed in order to attempt to clear the hazardous situation.



### Grid-tied

P ramp up:	2.0 %
P ramp down:	2.0 %
Q ramp up:	2.0 %
Q ramp down:	2.0 %

2021-03-28-14:13:12

Ramp P and Ramp Q down determine the rate of change of the P and Q references respectively. Unique ramp rates are available for Island and Grid-tied operation respectively. In case PV paralleling with gensets only and these are in reverse power or

overload state the ramps will be bypassed in order to attempt to clear the hazardous situation.

## Ramp threshold

On the same submenu level the setup page for Ramp threshold is found. Clicking the up/down arrows will lead to it. When starting the PV plant the ECpvX offers an initial ramp threshold to avoid the PV reference being ramped up before even connecting the inverters.

### ENcombi

ADMIN

#### Ramp thr.

P Target: 5.0 %

Ramp P Thr.: 1.0 %

Ramp Thr. del.: 10.0 s

#### Ramp interlock

Bat charge: 5 kW



PV ramp threshold and interlock setup page.  
The power reference will be kept at the target value.  
When the PV power exceeds the threshold value then the timer will start to run. When the time exceeds the threshold delay then the ramping is released.  
The ramping of the PV is limited in relation to battery charge sequence when the power difference between the PV charge production exceeds the battery charge intake with this amount.



2022-09-30-09:29:41

As long as the threshold delay is not elapsed, then the ECpvX will use the threshold power target as the active power reference with a unity power factor for the PV plant. The threshold timer will start to run when the PV power production exceeds the Power threshold. Once the timer elapses, then the ramping is released and the PV reference will be ramped to the actual target references.

The Ramp interlock setting ties the battery charging from PV together meaning that it prevents the PV from ramping up faster than the battery can keep up with. The PV will wait for the battery if the charging difference exceeds the set value.

## Tariff

On the same submenu level the setup page for PV Tariff is found. Clicking the up/down arrows will lead to it.

Tarif

Export: 0.02 Euro/kWh



PV tariff setup page.  
The tariff for PV power produced.  
Used by device for calculating PV export save.

2021-03-28-14:13:34

This tariff is for revenue generated based on the PV generation alone. This revenue is referred to as PV export save.

## Counters

On the same submenu level pages for various PV related counters are found. Clicking the up/down arrows will lead to them.

- Produced energy (daily, monthly, yearly and total).
- Curtailed energy (daily, monthly, yearly and total).
- PV export save (daily, monthly, yearly and total).
- Mains import save (daily, monthly, yearly and total).
- Fuel save (daily, monthly, yearly and total).
- Fuel expense save (daily, monthly, yearly and total).
- CO2 emission save (daily, monthly, yearly and total).

Below is an example.

Produced	Active	Update
ACE:	0 kWh	<input type="text" value="0 kWh"/>
ACE YEAR:	0 kWh	<input type="text" value="0 kWh"/>
ACE MONTH:	0 kWh	<input type="text" value="0 kWh"/>
ACE DAY:	0 kWh	<input type="text" value="0 kWh"/>
Curtailed	Active	Update
ACE:	0 kWh	<input type="text" value="0 kWh"/>
ACE YEAR:	0 kWh	<input type="text" value="0 kWh"/>
ACE MONTH:	0 kWh	<input type="text" value="0 kWh"/>
ACE DAY:	0 kWh	<input type="text" value="0 kWh"/>
Curtailmnt thrs.:	97.0 %	<input type="text" value="97.0 %"/>

ADMIN

2021-03-28-14:14:20

The counters will be incremented automatically by the ECpvX in accordance with operation conditions. The counters are part of the counters backup discussed in the Identifier chapter.

The menus are only providing the possibility for manually presetting of the counters. Counters with a check mark in the update column will be preset with the keyed in value when the save button is pressed. Toggle between check mark and cross mark by pressing the respective buttons.

Curtailment threshold determines how close actual PV power production must be to the power reference before ECpvX interprets it as curtailment is ongoing. Curtailment state can only be set in case reference is below 100%.

## Meter

Clicking the power meter button on the right hand side of any of the above pages leads to the following page.

### PV

Power meter:	OFF
Modbus type:	RTU
ID:	2
IP:	192.168.1.50
Number:	1
TCP-RTU converter:	DISABLED



PV power meter setup page.  
 A maximum of 16 power meters for PV is supported.  
 The same make/model must be used for all PV measurements.  
 The communication can be either Modbus RTU or TCP.

The Modbus IDs of the meters must be sequential in case of RTU, with lowest ID being equal to the setting made in the device.

The IP addresses of the meters must be sequential in case of TCP, with lowest IP address being equal to the setting made in the device.  
 The Modbus ID selected is used in the TCP frames.

In case interfacing with Modbus TCP to Modbus RTU meters via a TCP-RTU converter, then this setting must be enabled.  
 The IP address is then to be set equal to that of the converter and the modbus IDs are then used in the TCP frames from the ECpvX to identify the individual meters.

Port settings is setup on dedicated port setup page.

A maximum of 16 power meters for PV is supported. The same make/model must be used for all PV measurements. The communication can be either Modbus RTU or TCP. Check the link below to see which meters are supported by ECpvX.

<http://www.encombi.com/products/ECpvx/>

Should your preferred meter not be on the list already, contact ENcombi to request the adding of it.

The Modbus IDs of the meters must be sequential in case of RTU, with the lowest ID being equal to the setting made in the ECpvX.

The IP addresses of the meters must be sequential in case of TCP, with the lowest IP address being equal to the setting made in the ECpvX. The Modbus ID selected is used in the TCP frames.

In case interfacing with Modbus TCP to Modbus RTU power meters via a TCP-RTU converter, then the dedicated setting must be enabled. The IP address is then to be set equal to that of the converter and the Modbus IDs are then used by the ECpvX in the Modbus TCP frames to identify the individual power meter.

Meter communication on Modbus RTU runs on RS485 COM2 port as discussed earlier in this chapter.

## Relay

On the same submenu level the page for setting up relay outputs on the power meters is found. Clicking the up/down arrows will lead to them.

## PV relay 1

Enable: DISABLED

Type: NO

## PV relay 2

Enable: DISABLED

Type: NO



PV meter relay setup page.  
The relay needs to be enabled with the intended functionality.  
Furthermore normal state "open" or "closed" can be set.

2020-07-10-13:32:54

A total of two relay outputs can be controlled.

The relay needs to be enabled with the intended functionality.

1. Disabled
2. Alarm
3. EClogic

Furthermore the relay can be configured to be normally open or normally closed.

Relay control is not supported for all the power meters. Consult the Modbus Master documentation on ENcombi website to learn for which power meters relay feature is support:

<http://www.encombi.com/products/ecpvx/>

### CT settings

On the same submenu level the page for setting up CT and VT settings for the power meters is found. Clicking the up/down arrows will lead to them. This feature applies for the Pilot SPM32 and SPM33 meters only. The Pilot meter CT and PT settings will by default automatically be read from the SPM32 and SPM33 power meters. If the CT and VT used on all PV meters are the same you can choose to type them in here and then have the ECpvX use those settings. This will speed up the loop time polling rate.

**PV**

CT1: 5 A

PT1: 22 times 10V

PT2: 220 V

Enable: DISABLED



PV meter CT and PT setup page.  
 The Pilot meter CT and PT settings will per default automatically be read from the SPM32 and SPM33 power meters. If the CT and VT used on all PV clusters are the same you can choose to type them in here and then have the ECpX use those settings. This will speed up the loop time polling rate for the meters.

2023-08-31-09:58:12

## Frame settings

On the same submenu level the frame setup is found. Modbus frames that only contain either energy counters or digital inputs can be disabled from this page. This will speed up the loop time polling rate for meters using separate KWH or DIGIN frames.

**Frame:**

KWH Frame: ENABLED

DIGIN Frame: ENABLED



PV meter frame setup page.  
 Modbus frames containing only energy counters or digital inputs can be disabled individually. This will speed up the loop time polling rate for meters using separate KWH or DIGIN frames.

2024-04-16-14:37:23



## Inverter

Clicking the inverter button leads to the following page.

**ENcombi** ADMIN

**Inverter**

Protocol:	OFF
Modbus type:	RTU
Control Fnc:	0x10
Control:	ENABLED
Data acquisition:	ENABLED
Number:	4

**Inverter setup page.**  
 The device can interface to inverters via Modbus RTU or Modbus TCP.  
 Besides controlling the inverters, the device can also do data acquisition.  
 If data acquisition enabled, the device will read production data from all the inverters.  
 The data read, will be visualized on dedicated page.

2020-07-10-13:33:20

A maximum of 32 inverters is supported by a single ECpvX. In case more than 32 inverters are to be controlled, multiple ECpvX can be stacked to work together. This is discussed in a separate chapter later in this document. All inverters controlled by a single ECpvX must be of the same vendor and possibly model. The communication can be either Modbus RTU or TCP.

Check the below link to see which inverters are supported by ECpvX.

<http://www.encombi.com/products/ecpvx/>

Should your preferred inverter not be on the list already, contact ENcombi to request the adding of it.

Controlling the inverters and data acquisition from the inverters can be enabled/disabled independently. ECpvX supports Modbus function code 0x06 and 0x10 for applying control commands. Some inverters support only one of the two. Consult the Modbus Master documentation on ENcombi website to learn which function code to use with your inverter:

<http://www.encombi.com/products/ECpvx/>

If data acquisition is enabled, the data read from the inverters, will be visualized on dedicated pages under monitoring.

## RTU

On the same submenu level the page for setting up Modbus RTU specifics for inverter communication is found. Clicking the up/down arrows will lead to it.

## RTU

Control type:	UNICAST
Initialization ID:	0
Broadcast ID:	0
Control ID:	1
Acquisition ID:	1



Inverter interface via Modbus RTU setup page.

The device can apply references as Unicast or as Broadcast.  
Unicast is applicable when interfacing to a single unit.  
This being a single inverter or a controller managing a pool of inverters.  
Broadcast is applicable for controlling a pool of inverters without the presents of a managing controller.

The modbus broadcast ID is configurable.  
Default and modbus standard is 0.

The Control ID is used for Unicast.  
If a managing controller is present the Control ID is to match that device.  
If no managing controller is present, the Control ID shall be set equal to the Acquisition ID.

The Identification ID used for protocol map identification routine.

The Acquisition ID shall be set equal to the lowest inverter ID present.  
When Acquisition enabled the device will read data from the inverters.  
The device will read from Acquisition ID on onwards, until the number of inverters selected is reached.  
The IDs of the inverters must be sequential.

2020-07-10-13:33:48

The ECpvX can apply references as Unicast or as Broadcast. Unicast is applicable when interfacing to a single unit. This being a single inverter or a controller managing a pool of inverters. Broadcast is applicable for controlling a pool of inverters without the presence of a managing controller.

The Control ID is used for Unicast. If a managing controller is present the Control ID is to match that device. If no managing controller is present, the Control ID shall be set equal to the Acquisition ID.

If the inverters do not support Broadcast, a pool of inverters can be controlled using Unicast still. In this case Control ID shall be set equal to the Acquisition ID.

The Initialization ID is used for any protocol initialization routine such as SunSpec map identification.

The Acquisition ID shall be set equal to the lowest inverter ID present. When Acquisition enabled the device will read data from the inverters. ECpvX will read from Acquisition ID and onwards, until the number of inverters selected is reached. The IDs of the inverters must be sequential.

## TCP

On the same submenu level the page for setting up Modbus TCP specifics for inverter communication is found. Clicking the up/down arrows will lead to it.

## TCP

Control IP: 192.168.1.50

Acquisition IP: 192.168.1.50

TCP-RTU converter: DISABLED



Inverter interface via Modbus TCP setup page.

When controlling a pool of inverters, without the presents of a managing controller, the Control IP is to be set differently than the Acquisition IP. The RTU Initialization ID is in this case used for any initialization frames. The RTU Control ID is in this case used for all other frames. The IP addresses of the inverters must be sequential.

When controlling a single inverter or a pool of inverters with the presents of a managing controller, the Control IP is to be set equal to the Acquisition IP. The RTU Initialization ID is used for any initialization frames. The RTU Control ID is used for the control frames. The RTU Acquisition IDs are used for the data acquisition frames.

When controlling a single inverter or a pool of inverters via TCP-RTU converter, the Control IP is to be set equal to the Acquisition IP. The RTU Initialization ID is used for any initialization frames. The RTU Control IDs are used for the control frames. The RTU Acquisition IDs are used for the data acquisition frames.

2020-07-10-13:40:48

When controlling a pool of inverters, without the presence of a managing controller, the Control IP is to be set differently than the Acquisition IP.

- The RTU Initialization ID is used for all TCP frames related to protocol initialization routines such as the SunSpec map identification.
- The RTU ControlID is used for TCP frames for both acquisition and control references. The IP addresses of the inverters must be sequential.

When controlling a single inverter or a pool of inverters with the presence of a managing controller, the Control IP is to be set equal to the Acquisition IP.

- The RTU Initialization ID is used for all TCP frames related to protocol initialization routines such as the SunSpec map identification.
- The RTU Control ID is used for the TCP frames related to control references.
- The RTU Acquisition IDs are used for the TCP frames related to data acquisition.

Controlling a single inverter or a pool of inverters via a TCP/RTU converter can be useful sometimes if ECpvX is to coexist with a datalogger for instance. In this case the Control IP is to be set equal to the Acquisition IP.

- The RTU Initialization ID is used for all TCP frames related to protocol initialization routines such as the SunSpec map identification.
- The RTU Control ID is used for the TCP frames related to control references.
- The RTU Acquisition IDs are used for the TCP frames related to data acquisition.

This approach is not recommended with big inverter clusters as the Modbus TCP from ECpvX will give references to the inverters individually. When passing this through a TCP/RTU converter the speed is limited to the serial line performance slowing this way down. For big clusters of inverters, going directly with Modbus RTU from ECpvX via a serial line multiplexer is considered the best option as references can then be applied as broadcast commands.

## Advanced Inverter command setup

On any of the above inverter pages clicking the Command button will lead to the below page for advanced inverter command setup.

**ENcombi** ADMIN

**Inverter Cmd**

Interval:	300.0 s
P timeout:	60 s
Q timeout:	60 s

Common inverter command setup page.  
 The delay between transmission of commands  
 that is set to be transmitted at defined interval  
 and reference fallback timeout values can be set here.  
 Protocol specific command configuration  
 is found on the following pages.

2020-07-10-13:41:08

These settings are common for all inverters and may or may not apply to the specific inverter make/model selected. Here the delay between transmission of commands that is set to be transmitted at a defined interval can be set. Furthermore the fallback timeouts for reverting to a predefined production level in case of loss of communication can be set up.

## SunSpec inverter command setup

Clicking the up/down button will lead to the SunSpec command setup page.

The screenshot shows the ENcombi web interface. On the left, there is a table with the following settings:

SunSpec Cmd	
P enable:	CONTINUOUSLY
Q enable:	CONTINUOUSLY
P timeout:	DISABLE
Q timeout:	DISABLE
P scale:	AUTOMATIC
Q scale:	AUTOMATIC
SunSpec Acq	
I160:	ENABLED

In the center, there is a warning box with the following text:

SunSpec command setup page.  
 The commands for enabling of P and Q references can be disabled, transmitted at defined interval or be transmitted continuously.  
 The commands for timeout of P and Q references can be disabled, transmitted at defined interval or be transmitted continuously. The timeout values to sent are set up on the common inverter command page.  
 The resolution used for power and reactive power references can be adjusted.

At the top right, there is an 'ADMIN' link and a red 'L' icon. At the bottom right, the timestamp '2020-11-18-12:07:05' is visible.

For SunSpec protocol the commands for enabling P and Q references can be disabled, transmitted at a defined interval or be transmitted continuously. The same is the case for the transmission of the fallback timeout values.

The number of decimals used when applying the power and reactive power control commands can be adjusted. Default selection is "Automatic" as this is detected as part of SunSpec. However, in some cases it is found that the inverter vendors implementation is not according to the standard (due to old SW in the inverter or similar) and in those cases the automatics can be overruled and the number of decimals used can be fixed in accordance with the actual behavior of the inverter.

It can further be enabled/disabled whether to include the Multiple MPPT Extended Inverter Model (I160) as part of the inverter data acquisitioning.

## Secondary inverter setup

Clicking the up/down button will lead to the Secondary inverter setup page.

## Secondary inverter

Protocol:	OFF
Control Fnc:	0x10
Number:	1
Control:	DISABLED
Data acquisition:	DISABLED



**Secondary inverter setup page.**  
The device can control a PV plant with a mix of up to two different inverter models.

On this page a secondary inverter model can be enabled. It is enabled by selecting a protocol and how many of the total number of inverters present that are of the secondary type.

On the primary inverter setup page inverter, the number of inverters to set must be the total number of inverters in the plant.

Secondary inverter support only applies for Non SunSpec protocols running on Modbus RTU and using Unicast command method.

The modbus IDs of all the inverters must be sequential with the primary inverters having the lowest IDs in the sequence.

2022-03-14-10:58:38

The ECpvX can control a PV plant with a mix of up to two different inverter models. On this page a secondary inverter model can be enabled. It is enabled by selecting a protocol and how many of the total number of inverters present that are of the secondary type. On the primary inverter setup page inverter, the number of inverters to set must be the total number of inverters in the plant. Secondary inverter support only applies for Non SunSpec protocols running on Modbus RTU and using the Unicast command method. The modbus IDs of all the inverters must be sequential with the primary inverters having the lowest IDs in the sequence.

## Multiple inverter cluster setup

Clicking the up/down button will lead to the pages for setting up multiple inverter clusters. An inverter cluster in this context is defined as one or more inverters being connected to a superior datalogger like a Huawei Smartlogger, a Sungrow COM100E or a SMA InverterManager. The ECpv2 can control up to 32 inverter clusters. Note that data acquisition of the individual inverters is limited to a maximum of 32 inverters. In the menu below it is set up how the total installed inverter capacity is split between the individual inverter clusters.

### Cluster capacity

Cluster 1:	50.0 %
Cluster 2:	50.0 %
Cluster 3:	0.0 %
Cluster 4:	0.0 %
Cluster 5:	0.0 %
Cluster 6:	0.0 %
Cluster 7:	0.0 %
Cluster 8:	0.0 %



**Inverter cluster setup page.**  
 The device can control a PV plant made up of multiple inverter clusters each being connected to a superior datalogger like the Huawei Smartlogger or the Sungrow COM100E.  
 On this page the capacity of each of these clusters are to be set. It is set in percentage of the total installed inverter capacity in the entire PV plant.

2022-06-28-11:59:10

In the menu below it is set up how many inverters are present in the individual clusters.

### Cluster inverter nbr

Cluster 1:	4
Cluster 2:	6
Cluster 3:	0
Cluster 4:	0
Cluster 5:	0
Cluster 6:	0
Cluster 7:	0
Cluster 8:	0



**Inverter cluster setup page.**  
 The device can control a PV plant made up of multiple inverter clusters each being connected to a superior datalogger like the Huawei Smartlogger or the Sungrow COM100E.  
 On this page the number of inverters present in each of these clusters are to be set.

2022-06-28-12:00:38

The IP addresses of the superior dataloggers of the inverter cluster must come in a sequential order. Furthermore the Modbus IDs of the inverters in the individual clusters must be sequential and the Modbus ID sequence in each inverter cluster must start at the same value.

When making a multi cluster plant then the setting normally used for the number of inverters being present is instead referring to the number of inverter clusters (superior data loggers) being present.

### Inverter PID control

On the same submenu level the page for configuring PID control of the Inverters. Clicking the up/down arrows will lead to them.

**P PID**

Enable: DISABLED

Kp: 0.1

Ki: 0.025

Kd: 0.1

**Q PID**

Enable: DISABLED

Kp: 0.1

Ki: 0.025

Kd: 0.1



Inverter PID setup page.  
Per default the Inverter control is open loop.  
Here closed loop PID control can be enabled and adjusted.  
It can be selected whether to make the control using  
the active and reactive power adjustment control  
registers directly or indirectly via the voltage and frequency  
adjustment control registers instead.

2024-02-20-12:56:17

By default the PID control is disabled and the Inverter control is open loop. Closed loop control can help achieve the desired power output when controlling multiple PV inverters even if one or more of them do not produce the desired output. Active and Reactive power PID control can be enabled separately.



## Battery

### Ratings

Clicking the Battery button leads to the below page where the rated values of the battery installation are set up.

**ENcombi** ADMIN

Rated	
Inverter S:	100.0 kVA
Inverter Q:	100.0 kVAr
Battery P:	100.0 kW
Hour:	1.0 hour

Battery capacity setup page.  
S and Q refers to installed inverter capacity.  
P and hours refers to installed battery capacity.

2023-04-16-10:41:15

The S and Q ratings refer to the Power Conversion System whereas the P and Hour refer to the installed battery capacity.

### Measurements

On the same submenu level the setup page for sensing methods are found. Clicking the up/down arrows will lead to it.

**ENcombi** ADMIN

Measurement	
Sensing method:	SUM ALL PHASES
kW Origin:	BESS
kWh Origin:	ECPVX

Battery measurement setup page.  
Sensing method determines if to base reference on the sum of all phases or 3 x sensing values.  
kW origin determines from which source the battery power production arises.  
kWh origin determines from which source the battery energy production arises.

2023-08-31-10:10:15

Sensing method determines what power readings to base the calculated references upon. Two options are available.

3. Sum all phases.
4. 3 x sensing.

#### *Sum all phases*

The control will work on the total loading of all phases.

#### *3 x sensing*

Only one CT is installed, sensing the production on one phase only. The phase production measured is representative for the production on the other two phases. The ECpvX will multiply the production sensed with three in order to get the total production.

kW origin determines from where to retrieve the battery power production. Supported methods are:

1. BESS.
2. Battery meter.
3. Mains reading.

#### *BESS*

The ECpvX will take the power contribution of the BESS directly from its own power measurements via the PCS communication.

#### *Battery meter*

The ECpvX will take the power contribution of the BESS via a power meter installed at the AC output line of BESS.

#### *Mains reading*

This will have ECpvX use the Mains power readings as an expression for the BESS production as well. This can be used in an On-grid BESS plant without any site load being present.

kWh origin determines from where to retrieve the battery energy production.

Supported methods are:

1. ECpvX.
2. PCS

#### *ECpvX*

Based on the kW measured, the ECpvX integrates energy counters itself.

#### *PCS*

Based on the kWh energy counter in the PCS.

## Reference limits

On the same submenu level the setup pages for battery reference limits are found. Clicking the up/down arrows will lead to them.

**ENcombi** ADMIN

**Reference limits**

Priority: OFF

Mains lim: 100.0 %

DG lim: 100.0 %

Cosphi cap: 0.600 C

Cosphi ind: 0.600 I

Cosphi lim: DISABLED

Battery reference limits setup page.  
Priority setting determines whether to prioritise P or Q reference over the other in case exceeding rated S inverter capacity.

Max dispatch limits can be set for parallel operation to both grid and gensets respectively. In case the reference is exceeding, the device will limit the P reference.

Cosphi cap and Cosphi ind outlines operating range of the inverters. In case enabled and reference exceeding, the device will limit the Q reference.

2023-08-31-10:09:37

Priority setting determines whether to prioritize P or Q reference over the other in case exceeding rated S inverter capacity.

Maximum power dispatch limits can be set for grid and genset operation respectively. In case the reference calculated by the control schemes exceeds the limits, then the reference will be truncated to the limits.

Cosphi cap and Cosphi ind outline the operating range of the inverters. In case enabled and reference exceeds the outlined range, the ECpvX will limit the Q reference.

**ENcombi** ADMIN

**Reference limits**

OCC dist: 10 kW

SOC max: 98.0 %

SOC min: 10.0 %

OCC lim: ENABLED

ODC lim: ENABLED

Battery reference limit setup page.

The safety distance to keep from the actual charging capacity of the battery can be set in kW.

The overall SOC limits for charging and discharging can be set.

Whether to acknowledge and not compromise any charging and discharging power limits received from either the PCS or the BMS can be set.

2023-08-31-10:09:08

When the battery is charging it is possible to set a safety distance in order to keep the reference close to the actual charging.

SOC maximum setting is a superior limit that will suppress all further charging when parallel to either genset or grid.

SOC minimum setting is a superior limit that will suppress all further discharging when parallel to either genset or grid.

Whether to acknowledge and not compromise any charging and discharging limits received by the PCS/BMS can be set.

## Ramp rates

On the same submenu level the setup page for battery ramp rates are found. Clicking the up/down arrows will lead to it.

ENcombi ADMIN

**Island**

P ramp up:	2.0 %
P ramp down:	2.0 %
Q ramp up:	2.0 %
Q ramp down:	2.0 %

**Grid-tied**

P ramp up:	2.0 %
P ramp down:	2.0 %
Q ramp up:	2.0 %
Q ramp down:	2.0 %

Battery ramp rate setup page.  
Ramp P and Ramp Q down determines the rate of change of the P and Q references respectively.  
In case battery is paralleling with gensets only and these are in reverse power or overload state the ramps will be bypassed in order to attempt to clear the hazardous situation.

2023-08-31-10:08:42

Ramp P and Ramp Q down determine the rate of change of the P and Q references respectively. Unique ramp rates are available for Island and Grid-tied operation respectively. In case battery paralleling with gensets only and these are in reverse power or overload state the ramps will be bypassed in order to attempt to clear the hazardous situation.

## Minimum battery load

On the same submenu level the setup page for minimum battery is found. Clicking the up/down arrows will lead to it.

## References

Min. battery load:	5.0 kW
--------------------	--------



Battery reference setup page.  
Reference applies for when running parallel to PV only.  
The setting dictates the amount of load to leave for the battery to carry.



2023-08-31-10:08:11

When the battery is parallel with PV only, it can be selected how much loading there should be kept on the battery. The ECpvX will seek to have the PV pick up any excessive load.

## Dispatch DG

On the same submenu level the setup page for dispatch DG is found. Clicking the up/down arrows will lead to it.

## Dispatch DG

Battery dispatch:	ENABLE
-------------------	--------

Start hour:	22 h
-------------	------

Start minute:	0 min
---------------	-------

Stop hour:	6 h
------------	-----

Stop minute:	0 min
--------------	-------



Battery dispatch with genset setup page.  
When parallel with genset it is possible to setup when the battery are allow to dispatch.  
The dispatch with genset can also be limited to a defined time period.  
This period can be set with the associated parameters.



2023-08-31-10:07:50

When the battery is parallel with the genset it is possible to select if the battery should be able to dispatch power. It is possible to select if the battery should be able to dispatch all the time or in a specific period of time when parallel to DG.

If dispatch is disabled, the battery will still help the genset if the load is bigger than the DG capacity.

## Dispatch grid

On the same submenu level the setup page for dispatch grid is found. Clicking the up/down arrows will lead to it.

### Dispatch grid

Battery dispatch:	ENABLE
Start hour:	22 h
Start minute:	0 min
Stop hour:	6 h
Stop minute:	0 min
Max load pct:	80.0



Battery dispatch with grid setup page.  
When parallel with grid it is possible to setup when the battery is allow to dispatch.

The dispatch with grid can also be limited to a defined time period.  
This period can be set with the associated parameters.

The dispatch can also be set to follow the charge/discharge scheduler.  
The scheduler is set up in the EClogic menu. The scheduler only works when the Battery Ctrl mode is set to Fixed Power.

The maximum loading of the grid transformer when power is being dispatched can be set.



2023-08-31-10:06:31

When the battery is parallel with the grid it is possible to select if the battery should be able to dispatch power. It is possible to select if the battery should be able to dispatch all the time or only in a defined period of time. The maximum loading of the transformer allowed can be adjusted by the dedicated setting. If dispatch is disabled, the battery will still help the grid if the load is bigger than the grid capacity.

## PV charge

On the same submenu level the setup page for PV charge is found. Clicking the up/down arrows will lead to it.

### PV charge

PV charging:	DISABLED
SOC start:	95.0
SOC stop:	100.0
Grid prio:	PV REFERENCE
Genset prio:	BATTERY



PV charging setup page.  
Charging from PV can be enabled.  
The SOC trigger values for initiating and aborting charging can be set.  
Whether to prioritise available PV for maintaining the PV reference or charge the battery can be selected.



2023-08-31-10:06:07

Enable charging from PV can be done at this page. SOC start will determine when to start charging from PV, if any available PV power. SOC stop will determine when to stop charging from PV. Furthermore, it can be selected whether to prioritize the PV power to meet the PV reference or to charge the battery. Alternatively, EClogic can be selected to overrule the setting based on the EClogic Battery Charge PV priority Modbus register. Consult the Modbus slave documentation on ENcombi website for details on addresses to use:

<http://www.encombi.com/products/ecpvx/>

The PV charge priority can be set independently for grid and genset parallel operation.

When in grid parallel operation the PV charging is only active whenever the “Mains ctrl. method” for the battery is set to “System P”.

## DG charge

On the same submenu level the setup page for DG charge is found. Clicking the up/down arrows will lead to it.

ENcombi ADMIN

**DG charge**

DG charging: DISABLE

SOC start: 10.0

SOC stop: 80.0

Charge pct: 100.0

Max load pct: 80.0

**Timer**

Start hour: 22 h

Start minute: 0 min

Stop hour: 6 h

Stop minute: 0 min

Genset charging setup page.  
Charging from gensets can be enabled.  
The SOC trigger values for initiating  
and aborting charging can be set.  
Furthermore the target loading on gensets  
during charging can be set.  
The charging is also selectable from time period.  
This can be set in parameters.

2023-08-31-10:05:47

When parallel with gensets it is possible to charge the battery from the genset. The following options are available:

1. Disable
2. Enable
3. Timer

### *Disable*

The genset is not allowed to charge the battery if the SOC is going below SOC start.

### *Enable*

The genset is allowed to charge the battery when the SOC is below SOC start. The genset will run at the load percentage and charge the battery with the available power when the load is subtracted from the genset production.

### *Timer*

The genset is allowed to charge within a specific time period when the SOC is below SOC start. The charging will stop either if the SOC goes above SOC stop or the time is expired.

The charge percentage is the requested charge power whereas the maximum load percentage determines the maximum loading on the gensets during charging.

## Minimum DG load charge

On the same submenu level the setup page for minimum DG load charge is found. Clicking the up/down arrows will lead to it.

**ENcombi** ADMIN

**Min. DG load charge**

DG charging:	DISABLED
SOC stop:	95.0

Genset charging setup page.  
 Allowing charging from genset to keep it at its minimum load  
 can be enabled here. If SOC reaches the stop threshold,  
 the battery will stop charging.

2023-08-31-10:05:24

When the battery is parallel with the genset and the load is below the minimum DG load. The battery is able to charge if the SOC is below SOC stop. The battery will start charging and keep the genset at minimum DG load. When the load increases above the minimum DG load the battery will stop charging. If the SOC goes above SOC stop, the battery will stop charging as well.

## Grid charge

On the same submenu level the setup page for grid charge is found. Clicking the up/down arrows will lead to it.



**Grid charge**

Grid charging: DISABLE

SOC start: 10.0

SOC stop: 80.0

Charge pct: 100.0

Max load pct: 80.0

**Timer**

Start hour: 22 h

Start minute: 0 min

Stop hour: 6 h

Stop minute: 0 min



Mains charging setup page.  
Charging from grid can be enabled.  
The SOC trigger values for initiating  
and aborting charging can be set.  
Furthermore the target loading on grid  
during charging can be set.

The charging is also selectable from time period.  
This can be set in parameters.



2023-09-31-10:05:01

When parallel with the grid it is possible to charge the battery from the grid.  
The following options are available:

1. Disable
2. Enable
3. Timer

*Disable*

The grid is not allowed to charge the battery if the SOC is going below SOC start.

*Enable*

The grid is allowed to charge the battery when the SOC is below SOC start. The grid will charge with the load percentage and charge the battery with the available power when the load is subtracted from the grid production.

*Timer*

The grid is allowed to charge the battery within a specific time period when the SOC is below SOC start. The charging will stop either if the SOC goes above SOC stop or the time is expired.

The charge percentage is the requested charge power whereas the maximum load percentage determines the maximum loading on the grid during charging.

Charging from the grid is only active whenever the "Mains ctrl. method" for the battery is set to either "System P" or "Fixed P".

*Grid mode backup*

On the same submenu level the setup page for backup grid settings is found. Clicking the up/down arrows will lead to it.

### Grid mode backup

Grid backup: ENABLED

### Backup capacity

Start SOC Threshold: 30.0

Stop SOC Threshold: 40.0

Enable backup capacity: DISABLED



Battery backup in grid mode setup page.  
The battery can be used as backup for the grid when operating in Grid mode.

When operating in grid mode the battery will stop contributing feeding the load when the SOC drops below the start threshold and will resume again when SOC exceeds the stop threshold.



2023-08-31-10:04:36

When the battery is operating in grid mode it is possible to let the battery backup if the grid fails. If the grid is failed the battery will continue operating without the grid, if grid backup is enabled.

### Backup capacity

When the battery is parallel with the grid it is possible to control when the battery should stop discharge power in order to keep a minimum capacity in backup. When the SOC goes below the Start threshold, the battery will stop contributing to feeding the load and will remain at 0kW.

When the SOC goes above the Stop threshold it will start to feed to the load again.

### Genset mode backup

On the same submenu level the setup page for backup genset settings is found. Clicking the up/down arrows will lead to it.

### Genset mode backup

Genset backup: ENABLED

### Backup capacity

Start SOC Threshold: 30.0

Stop SOC Threshold: 40.0

Genset backup: DISABLED



Battery backup in genset mode setup page.  
The battery can be used as backup for the genset when operating in Genset mode.

When operating in genset mode the battery will stop contributing feeding the load when the SOC drops below the start threshold and will resume again when SOC exceeds the stop threshold.



2023-08-31-10:04:12

When the battery is operating in genset mode it is possible to let the battery back up if the genset fails. If the genset is failed the battery will continue operating without the genset, if genset backup is enabled.

## Backup capacity

When the battery is parallel with the genset it is possible to control when the battery should stop discharge power in order to keep a minimum capacity in backup. When the SOC goes below the Start threshold, the battery will stop contributing to feeding the load and will remain at 0kW.

When the SOC goes above the Stop threshold it will start to feed to the load again.

## DOD settings

On the same submenu level the setup page for DOD settings is found. Clicking the up/down arrows will lead to it.

The screenshot shows the ENcombi web interface. At the top left is the ENcombi logo. At the top right is the word 'ADMIN'. Below the logo, there is a 'DOD settings' section with two rows: 'DOD high thr:' with a value of '90.0' and 'DOD low thr:' with a value of '50.0'. To the right of this section is a 'DOD threshold setup page' which contains the text: 'DOD threshold can be setup with a high and low threshold. When a full SOC cycle is made based on the threshold, the DOD counter will increase'. The page also features a pencil icon for editing and up/down arrows for navigation. On the far right, there is a vertical sidebar with several icons representing different system components.





DOD threshold can be set up in order to count a DOD cycle. When a full cycle is made based on the threshold, the DOD counter will increase.

## Counters

On the same submenu level pages for various Battery related counters are found. Clicking the up/down arrows will lead to them.

- Produced energy (daily, monthly, yearly and total).
- Consumed energy (daily, monthly, yearly and total).
- PV discharge (daily, monthly, yearly and total).
- PV charge (daily, monthly, yearly, total and available).
- Mains discharge (daily, monthly, yearly and total).
- Mains charge (daily, monthly, yearly, total and available).
- DG discharge (daily, monthly, yearly and total).
- DG charge (daily, monthly, yearly, total and available).
- DOD (daily, monthly, yearly and total).

Below is an example.

Produced	Active	Update	
Total:	0 kWh	<input type="text" value="0 kWh"/>	<input checked="" type="checkbox"/>
Year:	0 kWh	<input type="text" value="0 kWh"/>	<input checked="" type="checkbox"/>
Month:	0 kWh	<input type="text" value="0 kWh"/>	<input checked="" type="checkbox"/>
Day:	0 kWh	<input type="text" value="0 kWh"/>	<input checked="" type="checkbox"/>
 			
<div style="border: 1px solid black; padding: 5px;"> <p>Battery energy production counters preset page.            Counters with checkmark in the update column will be preset with keyed in value when save button is pressed.            Toggle between checkmark and crossmark by pressing the button.</p> </div>			
 			
Consumed	Active	Update	
Total:	0 kWh	<input type="text" value="0 kWh"/>	<input checked="" type="checkbox"/>
Year:	0 kWh	<input type="text" value="0 kWh"/>	<input checked="" type="checkbox"/>
Month:	0 kWh	<input type="text" value="0 kWh"/>	<input checked="" type="checkbox"/>
Day:	0 kWh	<input type="text" value="0 kWh"/>	<input checked="" type="checkbox"/>

2021-08-24-12:40:50

The counters will be incremented automatically by the ECpvX in accordance with operation conditions. The counters are part of the counters backup discussed in the Identifier chapter.

The menus are only providing the possibility for manually presetting of the counters. Counters with a check mark in the update column will be preset with the keyed in value when the save button is pressed. Toggle between check mark and cross mark by pressing the respective buttons.

## Meter

Clicking the power meter button on the right hand side of any of the above pages leads to battery meter configuration. The battery meter configuration is done in the exact same manner as the already covered PV power meter configuration. Refer to PV power meter configuration for setting up of battery power meter.

## Inverter

Clicking the inverter button leads to the following page.

## Inverter

Protocol:	OFF
Modbus type:	RTU
Control Fnc:	0x10
Control:	DISABLED
Data acquisition:	DISABLED



Battery inverter setup page.  
 The device can interface to a battery inverter via Modbus RTU or Modbus TCP.  
 Besides controlling the inverter, the device can also do data acquisition. If data acquisition enabled, the device will read production data from the inverter.  
 The data read, will be visualized on dedicated page.

2021-08-24-13:10:19

A maximum of 1 inverter is supported by a single ECpvX. The communication can be either Modbus RTU or TCP.

Check the link below to see which inverters are supported by ECpvX.

<http://www.encombi.com/products/ecpvx/>

Should your preferred inverter not be on the list already, contact ENcombi to request the adding of it.

Controlling the inverter and data acquisition from the inverter can be enabled/disabled. ECpvX supports Modbus function code 0x06 and 0x10 for applying control commands. Some inverters support only one of the two. Consult the Modbus Master documentation on ENcombi website to learn which function code to use with your inverter:

<http://www.encombi.com/products/ecpvx/>

If data acquisition is enabled, the data read from the inverters, will be visualized on dedicated pages under monitoring.

## RTU

On the same submenu level the page for setting up Modbus RTU specifics for inverter communication is found. Clicking the up/down arrows will lead to it.

## RTU

Control type: UNICAST

Control ID: 1



Inverter interface via Modbus RTU setup page.  
Here the Modbus ID of the battery inverter is set.



2021-08-24-13:43:34

The ECpvX can apply references as Unicast or as Broadcast. The Control ID is used for Unicast.

## TCP

On the same submenu level the page for setting up Modbus TCP specifics for inverter communication is found. Clicking the up/down arrows will lead to it.

## TCP

Control IP: 192.168.1.50



Inverter interface via Modbus TCP setup page.  
Here the IP address of the battery inverter is set.  
The RTU Control ID is used for the TCP frames.



2021-08-24-13:44:27

The RTU Control ID is used for the TCP frames.

## Advanced Inverter command setup

## Commands

On any of the above inverter pages clicking the Command button will lead to the below page for advanced inverter command setup.

## Inverter Cmd

P timeout:	60 s
Q timeout:	60 s
P Cmd:	DISABLED



Common inverter command setup page.  
Reference fallback timeout values can be set here.

Fast power control command transmission can be enabled.  
Intended usage is only when to fulfill ancillary service  
response time requirements.

Protocol specific command configuration  
is found on the following pages.

2023-12-15-16:17:13

These settings are common for all inverters and may or may not apply to the specific inverter make/model selected. Fallback timeouts for reverting to a predefined production level in case of loss of communication can be set up.

Frequent transmission of power control commands can be enabled. The intended usage is for when doing ancillary services to fulfill time response requirements.

## PCS mode handling

On the same submenu level the page for handling of PCS mode commands are found. Clicking the up/down arrows will lead to them.

## Inverter Cmd

Send Mode:	DISABLED
Grid on:	PQ MODE
Genset on:	PQ MODE
All off:	VF MODE
Seamless mode transfer:	DISABLED
Black start:	DISABLED
Stop at 0kW ref.:	DISABLED



Battery Advanced setup page.  
Note that the settings may not apply for all battery protocols.

Select if the battery should send mode commands to PCS and select the mode to send in the various operating conditions.

Select if the PCS is able to switch between operating modes seamless or it needs to be stopped down.

Select whether to activate dedicated black start sequence for black starting of the BESS.

Select if to send stop command to the BESS in case of 0kW reference when not in Off-grid operation.

2024-02-20-12:53:10

For some protocols it is possible to select whether the ECpvX should send mode commands to the PCS. Then the ECpvX will send the mode based on the operating condition. The operating mode for the various operating conditions can be set. All operating modes may not be supported by a given PCS. The support modes for the ECpvX to send is:

1. PQ mode
2. VF mode

## 3. VSG mode

The seamless mode transfer setting can be enabled from here. When seamless mode transfer is enabled, the ECpVX will not stop down the battery when the operating mode of the PCS is changed.

Some BESS requires a dedicated routine for doing black starting. In this case it can be set whether to enable and allow the black starting

When the reference for the PCS is 0kW for more than 60 seconds in a non off-grid operating condition, it can be chosen to command the PCS to stop.

### PCS PID control

On the same submenu level the pages for configuring PID control of the PCS. Dedicated menus for P/f and Q/U PID controls are available. Clicking the up/down arrows will lead to them.

**ENcombi** ADMIN

**P/F PID**

Enable:	DISABLED
Kp:	0.1
Ki:	0.025
Kd:	0.1
Kp offgrid:	1.0
Ki offgrid:	0.25
Kd offgrid:	0.05

**Inverter PID setup page.**  
 Per default the inverter control is open loop.  
 Here closed loop PID control can be enabled and adjusted.  
 It can be selected whether to make the control using the active and reactive power adjustment control registers directly or indirectly via the voltage and frequency adjustment control registers instead.  
 Dedicated PID factors are set for on-grid and off-grid operation.  
 The PID control is only active when the battery mode is set to VSG.

2024-05-26-08:54:10

**ENcombi** ADMIN

**Q/U PID**

Enable:	DISABLED
Kp:	0.1
Ki:	0.025
Kd:	0.1
Kp offgrid:	1.0
Ki offgrid:	0.25
Kd offgrid:	0.05

**Inverter PID setup page.**  
 Per default the inverter control is open loop.  
 Here closed loop PID control can be enabled and adjusted.  
 It can be selected whether to make the control using the active and reactive power adjustment control registers directly or indirectly via the voltage and frequency adjustment control registers instead.  
 Dedicated PID factors are set for on-grid and off-grid operation.  
 The PID control is only active when the battery mode is set to VSG.

2024-05-26-08:55:53

By default the PID control is disabled and the PCS control is open loop.



It can be selected whether to make the control using the active and reactive power adjustment control registers directly or indirectly via voltage and frequency adjustment control registers instead. The PIDs are active only when the battery mode is VSG. Dedicated PID factors exist for off-grid and on-grid respectively. The on-grid factors apply for situations when the BESS parallels with either the grid or genset(s).

## BMS

Clicking the battery button leads to the following page.

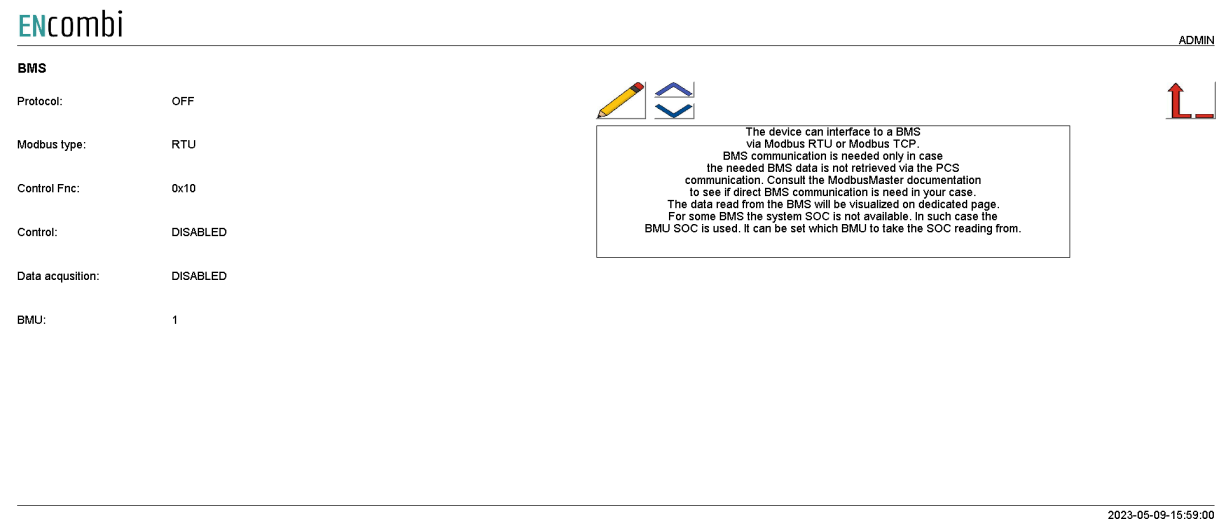

The screenshot shows the ENcombi BMS configuration page. The page header includes the ENcombi logo and an ADMIN link. The BMS settings are as follows:

BMS	
Protocol:	OFF
Modbus type:	RTU
Control Fnc:	0x10
Control:	DISABLED
Data acquisition:	DISABLED
BMU:	1

A warning box is present in the center of the page, containing the following text:

The device can interface to a BMS via Modbus RTU or Modbus TCP. BMS communication is needed only in case the needed BMS data is not retrieved via the PCS communication. Consult the ModbusMaster documentation to see if direct BMS communication is needed in your case. The data read from the BMS will be visualized on dedicated page. For some BMS the system SOC is not available. In such case the BMU SOC is used. It can be set which BMU to take the SOC reading from.

The page footer shows the date and time: 2023-05-09-15:59:00.

A maximum of 1 BMS is supported by a single ECpvX. The communication can be either Modbus RTU or TCP. Some PCS have communication to the BMS itself and the ECpvX can get the needed BMS information via the PCS thereby making MBS communication obsolete. Check the link below to see which PCS are supported by the ECpvX and which can be handled without the need for separate BMS communication.

<http://www.encombi.com/products/ecpvx/>

Should your preferred inverter not be on the list already, contact ENcombi to request the adding of it.

Controlling the BMS and data acquisition from the BMS can be enabled/disabled. ECpvX supports Modbus function code 0x06 and 0x10 for applying control commands. Some BMS support only one of the two. Consult the Modbus Master documentation on ENcombi website to learn which function code to use with your BMS:

<http://www.encombi.com/products/ecpvx/>

If data acquisition is enabled, the data read from the BMS, will be visualized on dedicated pages under monitoring.

## RTU

On the same submenu level the page for setting up Modbus RTU specifics for BMS communication is found. Clicking the up/down arrows will lead to it.

### RTU

Control type: UNICAST

Control ID: 1



BMS interface via Modbus RTU setup page.  
Here the Modbus ID of the BMS is set.

2022-12-15-23:55:40

The ECpvX can apply references as Unicast or as Broadcast. The Control ID is used for Unicast.

### TCP

On the same submenu level the page for setting up Modbus TCP specifics for inverter communication is found. Clicking the up/down arrows will lead to it.

### TCP

Control IP: 192.168.1.50



BMS interface via Modbus TCP setup page.  
Here the IP address of the BMS is set.  
The RTU Control ID is used for the TCP frames.

2022-12-15-23:56:47

The RTU Control ID is used for the TCP frames related.

## HVAC

Clicking the fan button leads to the following page.

ENcombi

ADMIN

HVAC

Protocol: OFF

Modbus type: RTU

Control Fnc: 0x06

Control: DISABLED

Data acquisition: ENABLED

HVAC setup page.  
The device can interface to a HVAC system  
via Modbus RTU or Modbus TCP.  
The data read from the HVAC system will be visualized on dedicated page.

2023-04-16-10:38:35

A maximum of 1 HVAC system is supported by a single ECpvX. The communication can be either Modbus RTU or TCP. On the ENcombi website you can see which HVAC systems that are supported. Should your preferred inverter not be on the list already, contact ENcombi to request the adding of it.

<http://www.encombi.com/products/ecpvx/>

Controlling the HVAC and data acquisition from the HVAC can be enabled/disabled. ECpvX supports Modbus function code 0x06 and 0x10 for applying control commands. Some HVAC support only one of the two. Consult the Modbus Master documentation on ENcombi website to learn which function code to use with your HVAC:

<http://www.encombi.com/products/ecpvx/>

If data acquisition is enabled, the data read from the BMS, will be visualized on dedicated pages under monitoring.

## RTU

On the same submenu level the page for setting up Modbus RTU specifics for HVAC communication is found. Clicking the up/down arrows will lead to it.

**RTU**

Control type: UNICAST

Control ID: 3



HVAC interface via Modbus RTU setup page.  
Here the Modbus ID of the HVAC system is set.

2023-04-16-10:39:11

The ECpvX can apply references as Unicast or as Broadcast. The Control ID is used for Unicast.

**TCP**

On the same submenu level the page for setting up Modbus TCP specifics for inverter communication is found. Clicking the up/down arrows will lead to it.

**TCP**

Control IP: 192.168.1.50



HVAC interface via Modbus TCP setup page.  
Here the IP address of the HVAC system is set.  
The RTU Control ID is used for the TCP frames.

2023-04-16-10:39:50

The RTU Control ID is used for the TCP frames related.

## Genset

### Measurements

Clicking the mains button leads to the page below where the measurements used for the genset can be set up.

**ENcombi** ADMIN

Measurement	
GB Feedb. origin:	GENSET POWER
Threshold:	0.00 kW
KW Origin:	GENSET METER
kWh Origin:	ECPVX
Sensing method:	SUM ALL PHASES

Genset measurement setup page.

Sensing method determines if to base reference on the sum of all phases,  
3 x lowest loaded phase or 3 x sensing values.

GB feedback origin determines from which source  
the genset breaker position feedbacks arises.

kWh origin determines from which source  
the genset energy production arises.

2022-09-30-09:08:26

Sensing method determines what power readings to base the calculated references upon. Three options are available.

1. Sum all phases.
2. 3 x lowest phase.
3. 3 x sensing.

#### *Sum all phases*

The control will work on the total loading of all phases not regarding any potential asymmetry. Using this method with asymmetrical loads and a low minimum genset load can result in a situation where the load on individual phase(s) gets very low with the risk of reversing.

#### *3 x lowest phases*

The control will identify the least loaded phase and multiply this with three. This can be useful when load is asymmetrical avoiding the phenomenon described above. The net loading on the genset will be somewhat higher than the minimum genset load setting dictates but it will diminish the potential risk of feeding power into the genset(s) on the low loaded phase(s).

#### *3 x sensing*

This can be used when load is symmetrical. Only one CT is installed, sensing the load from one phase only. The phase load sensed is representative for the loading on the

other two phases. The ECpvX will multiply the load sensed with three in order to get the total load.

GB feedback origin determines from which source the genset(s) breaker position closed feedback arises. Three options are available.

- Power meter / genset controller.
- Genset power.
- EClogic.
- Modbus page 03.
- Bat. Comm.
- ECsync

#### *Power meter*

In case a power meter is used instead of a direct interface to a genset controller, the input1 of the power meter will be interpreted as genset breaker closed feedback. If interfacing to a genset controller, the genset breaker closed feedback will already be wired to the genset controller and can in most cases be read directly by ECpvX.

#### *Genset power*

Whether a gensets breaker is closed can also be detected on the power reading itself. If a power is read from the power meter that exceeds the threshold, both positive and negative, the associated genset breaker is interpreted as being closed.

#### *EClogic*

In more complex electrical infra structures having for instance sectional breakers separating part of the gensets from the PV plant, a condition of whether the gensets are at all connected to the same AC busbar section as the PV needs to be taken into consideration. Such conditions can be customized from within EClogic.

#### *Modbus page 03*

This will have ECpvX use the GB feedback data written from a superior controller/SCADA to the ECpvX proprietary modbus map page 3.

#### *Bat Comm.*

This will have ECpvX use readings from the BESS system. It depends on the make and model of BESS whether this option is supported.

#### *ECsync.*

This will have ECpvX use external GB connected input to the ECsync cabinet.

kW origin determines from where to retrieve/calculate the genset power production. Supported methods are:

1. Genset meter.
2. Modbus page 03.

### 3. ECsync

#### *Genset meter*

Up to 16 power meters for sensing Genset production can be installed. ECpvX will summarize the contributions from each of the meters into one common total for the genset power being produced.

#### *Modbus page 03*

This will have ECpvX use the genset power data written from a superior controller/SCADA to the ECpvX proprietary modbus map page 3.

#### *ECsync*

The ECpvX will use the power reading from the ECsync cabinet for genset power.

kWh origin determines from where to retrieve/calculate the genset energy production. Supported methods are:

1. ECpvX.
2. Power meters

#### *ECpvX*

Based on the kW measured, the ECpvX integrates energy counters itself.

#### *Power meters*

The ECpvX will read the total energy counter from the power meters and summarize those.

ECpvX will, based on this, derive daily, monthly and yearly energy counters.

The meter used must provide either the total energy counter or the total energy export counter in order to make use of this approach. Consult the Modbus master documentation on ENcombi website for detailed information about what data is read from the various meter models.

<http://www.encombi.com/products/ECpvx/>

Note that all counters derived from energy counters remain linked to the ECpvX energy counters still.

#### References

On the same submenu level the setup page for references used when parallelling PV and/or battery to genset(s) are used. Clicking the up/down arrows will lead to it.

## References

Min. genset load:	30.0 %
Upt. genset load:	30.0 %
Genset Q ctrl:	ALL Q
Cosphi cap:	0.800 C
Cosphi ind:	0.950 I



Genset reference setup page.  
References applies for when running parallel to genset only.

The device will regulate PV power production in order to keep gensets connected running at the minimum genset load setting and the battery power to keep the genset at the optimum load setting.

Genset Q ctrl determines the reactive power regulation.  
All Q: Gensets carry all the reactive loading until limits reached.  
Sharing Q: Same reactive loading on PV plant, battery and gensets.  
Same cosphi: Same cosphi on PV plant, battery and gensets.  
Fixed cosphi C DG: Fixed cap cosphi on the gensets.  
Fixed cosphi I DG: Fixed ind cosphi on the gensets.  
All Q no limits: Gensets carry all the reactive loading.

Cosphi cap and cosphi ind outlines the operating range of the gensets. In case compromised, the PV and battery will pick up excessive reactive loading in order to keep gensets within their operating range. This applies only for the selection "All Q" in Genset Q ctrl. setting.

2022-09-30-09:11:30

The ECpvX will regulate the PV power production in order to keep gensets connected running at the minimum genset load setting. The ECpvX will regulate the battery power production in order to keep gensets connected running at the optimum genset load setting.

Genset Q ctrl determines the reactive power regulation. Three options are available.

- All Q: the ECpvX will let the gensets carry all the reactive loading until they reach the cosphi limits.
- Sharing Q: the ECpvX will keep the same reactive loading on the PV plant and gensets.
- Same cosphi: the ECpvX will keep the same cosphi on the PV plant and gensets.
- Fixed cosphi C DG: the ECpvX will keep a fixed capacitive cosphi on the genset. The reference is determined by the "Cosphi cap" setting.
- Fixed cosphi I DG: the ECpvX will keep a fixed inductive cosphi on the genset. The reference is determined by the "Cosphi ind" setting.
- All Q no limits: the ECpvX will let the gensets carry all the reactive loading.

Cosphi cap and Cosphi ind outlines the operating range of the gensets. In case compromised the ECpvX will pick up excessive reactive loading in order to keep gensets within their operating range. This applies only when "All Q" selection is made in Genset Q ctrl. setting.

## Tariffs

On the same submenu level the setup page for genset tariffs is found. Clicking the up/down arrows will lead to it.



## Tarif

Efficiency:	0.25 liter/kWh
Price:	1.25 Euro/liter
Emission:	2.64 kg/liter



Genset tarif setup page.  
 Efficiency is used for calculating fuel volume consumed by the gensets as well as fuel volume saved by the PV plant.

Price is used for calculating fuel expense of the fuel volume consumed by the gensets as well as for the fuel expense spared by the PV plant.

Emission is used for calculating the CO2 emission generated fuel volume consumed by the gensets as well as for the CO2 emission spared by the PV plant.

2021-01-05-15:02:42

Efficiency is used for calculating fuel volume consumed by the gensets as well as fuel volume saved by the PV plant.





Price is used for calculating fuel expense of the fuel volume consumed by the gensets as well as for the fuel expense spared by the PV plant.

Emission is used for calculating the CO2 emission generated fuel volume consumed by the gensets as well as for the CO2 emission spared by the PV plant.

## Rated sizes

On the same submenu level the setup pages for gensets rated power are found. Clicking the up/down arrows will lead to them.

ENcombi ADMIN

Rated			
Genset 1:	100.0 kW	  <div style="border: 1px solid black; padding: 5px; text-align: center; margin-top: 5px;">Genset capacity setup page.</div>	  
Genset 2:	100.0 kW		
Genset 3:	100.0 kW		
Genset 4:	100.0 kW		
Genset 5:	100.0 kW		
Genset 6:	100.0 kW		
Genset 7:	100.0 kW		
Genset 8:	100.0 kW		

2021-01-05-15:03:15

A total of 16 gensets are supported. Above page is one of two pages available for setting up the rated genset sizes.

## Counters

On the same submenu level pages for various genset related counters are found. Clicking the up/down arrows will lead to them.

- Produced energy (daily, monthly, yearly and total).
- Fuel consumed (daily, monthly, yearly and total).
- Fuel expense (daily, monthly, yearly and total).
- CO2 emission (daily, monthly, yearly and total).

Below is an example.

ENcombi
ADMIN

Produced	Active	Update	
ACE:	0 kWh	<input type="text" value="450 kWh"/>	<input checked="" type="checkbox"/>
ACE YEAR:	0 kWh	<input type="text" value="500 kWh"/>	<input checked="" type="checkbox"/>
ACE MONTH:	0 kWh	<input type="text" value="400 kWh"/>	<input checked="" type="checkbox"/>
ACE DAY:	0 kWh	<input type="text" value="410 kWh"/>	<input checked="" type="checkbox"/>
Fuel consumed	Active	Update	
Total:	0 liter	<input type="text" value="0.0"/>	<input checked="" type="checkbox"/>
Year:	0 liter	<input type="text" value="0.0"/>	<input checked="" type="checkbox"/>
Month:	0 liter	<input type="text" value="0.0"/>	<input checked="" type="checkbox"/>
Day:	0 liter	<input type="text" value="0.0"/>	<input checked="" type="checkbox"/>

Genset production counters preset page.  
 Counters with checkmark in the update column will be preset with keyed in value when save button is pressed. Toggle between checkmark and crossmark by pressing the button.

2021-01-05-15:11:48

The counters will be incremented automatically by the ECpv in accordance with operation conditions. The counters are part of the counters backup discussed in the Identifier chapter.

The menus are only providing the possibility for manually presetting of the counters. Counters with a check mark in the update column will be preset with the keyed in value when the save button is pressed. Toggle between check mark and cross mark by pressing the respective button.

## Meter

Clicking the power meter button on the right hand side of any of the above pages leads to genset meter configuration. The genset meter configuration is done in the exact same manner as the already covered PV power meter configuration. Refer to PV power meter configuration for setting up of power meters.

## Genset management

Clicking the genset management meter button on the right hand side of any of the above pages leads to the genset management configuration.

First page presented is the below page where the genset management is configured.

ENcombi ADMIN

**Genset management**

Backup in Off mode:	DISABLED
Connect threshold:	20.0 %
Disconnect threshold:	80.0 %
Breaker settings:	NON-SYNC
Open point:	3.0 %
Grid backup:	DISABLED
Enable:	DISABLED

**Genset management setup page.**

**Backup in Off mode:**  
The genset will act as a backup for the battery in Off mode. It be if the battery is blocked for operation or if the SOC drops below the Connect threshold.

**Breaker setting:**  
Determines if genset is to be synchronized to the battery or if an open transition is to take place.

**Open point:**  
Determines the power level at which the genset stop signal is given when performing a power deload of the genset.

**Grid backup:**  
The genset will act as a backup for the Grid in Grid mode.

**Enable:**  
Enable/disable of the entire Genset Management scheme.

2021-08-24-13:57:27

### *Backup in off mode:*

If backup in off mode is enabled, the genset will act as backup for the battery. If the SOC drops below the selected threshold or the battery is blocked for operation, the generator will start and backup the battery. If the SOC goes above the selected threshold or the battery is able to start again, the genset will stop down again.

### *Breaker settings:*

Selecting between synchronizing breaker on genset or non-sync breaker. The ECpvX is not in control of synchronizing breakers, but it will give a start signal to the genset and if the breakers are synchronized breakers, the battery will continue running and await the genset to synchronize and connect.

If the breakers are non-sync, the battery will stop down and make a blackout in order to start and close the genset breaker.

In order to stop the genset, the ECpvX will unload the genset and wait for the power to be less than the open point setting before sending a stop signal to the genset.

### *Grid backup:*

If the grid is in grid mode and there is a grid failure, the genset can act as backup if the battery is not allowed. The genset will start and carry the load until the grid is ready again.

## Load dependent start/stop

On the same submenu level pages for Load depending start/stop are found. Clicking the up/down arrows will lead to them.

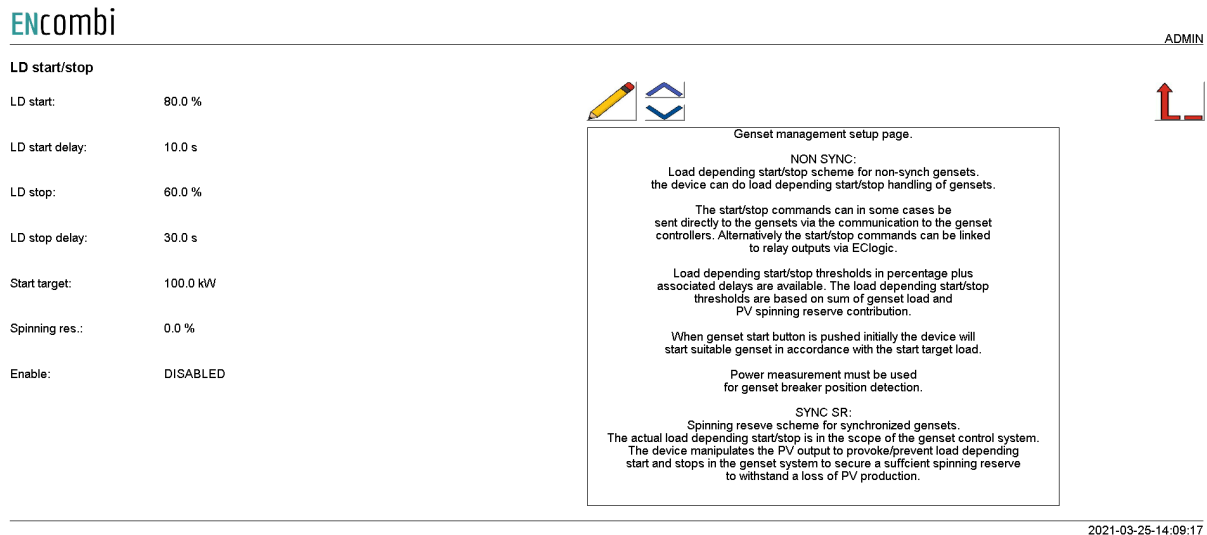

The screenshot shows the ENcombi web interface. On the left, there is a table for 'LD start/stop' settings:

LD start:	80.0 %
LD start delay:	10.0 s
LD stop:	60.0 %
LD stop delay:	30.0 s
Start target:	100.0 kW
Spinning res.:	0.0 %
Enable:	DISABLED

In the center, there is a box titled 'Genset management setup page.' containing the following text:

**NON SYNC:**  
Load depending start/stop scheme for non-synch gensets. the device can do load depending start/stop handling of gensets.

The start/stop commands can in some cases be sent directly to the gensets via the communication to the genset controllers. Alternatively the start/stop commands can be linked to relay outputs via EClogic.

Load depending start/stop thresholds in percentage plus associated delays are available. The load depending start/stop thresholds are based on sum of genset load and PV spinning reserve contribution.

When genset start button is pushed initially the device will start suitable genset in accordance with the start target load.

Power measurement must be used for genset breaker position detection.

**SYNC SR:**  
Spinning reserve scheme for synchronized gensets. The actual load depending start/stop is in the scope of the genset control system. The device manipulates the PV output to provoke/prevent load depending start and stops in the genset system to secure a sufficient spinning reserve to withstand a loss of PV production.

At the bottom right of the screenshot, the date '2021-03-25-14:09:17' is visible.

The ECpvX can do load depending start- and stop handling of gensets for two types of genset systems.

1. Non-Sync.  
Routine for non synchronizing gensets.
2. Sync SR.  
Routine for synchronizing gensets with its own build in load depending start/stop scheme.

## Non-sync.

This routine is for non-synch gensets. The ECpvX will at all times only request for one genset to be connected and when swapping gensets it will make certain that one is disconnected before the next one is started and connected.

The start/stop commands can in some cases be sent directly to the gensets via the communication to the genset controllers. Consult the Modbus master documentation on ENcombi website to find out which supports this:

<http://www.encombi.com/products/ECpvx/>

Alternatively the start/stop commands can be linked to relay outputs via EClogic. Consult the Modbus slave documentation on ENcombi website for details on addresses to use:

<http://www.encombi.com/products/ecpvx/>

The load depending start threshold is compared to the sum of genset loads and the PV spinning reserve contribution. The PV spinning reserve contribution is a percentage of

the actual load carried by the PV plant. When the condition is fulfilled for the selected load depending start delay, the ECpvX will start a larger, more suitable genset for the load if available.

The load dependent stop threshold is compared to the sum of genset load and PV load. This is to make certain that when a smaller gensets is started to replace a bigger running genset that it will be able to carry the full load present which it will have to as PV production is temporarily lost when transitioning from the big to the small genset.

When genset management is enabled an additional start/stop button appears on the monitoring pages (see later) for starting and stopping of the genset plant. When the genset start button is pushed initially, the ECpvX will start a suitable genset in accordance with the start target load.

“Genset Power” must be selected as the means for GB feedback detection.

Sync SR.

This routine is for synchronizing gensets with its own build in load depending start/stop scheme.

The actual load depending start/stop is carried out by the genset control system but the ECpvX will manipulate the loading on the gensets (via control of the PV production) to provoke/prevent load depending start and stops. The ECpvX does so based on the Spinning reserve requested in the genset system. The PV spinning reserve request is the percentage setting set of the actual load carried by the PV plant.

To be able to withstand a complete loss of PV production at all times, the Spinning reserve should therefore be set to 100%. If the genset capacity needed (actual load plus the spinning reserve request) on the AC bus exceeds the load depending start threshold, then the ECpvX will, after the load depending start delay expires, bring the genset up to that load depending start load by curtailing the PV. This will provoke a load depending start in the genset system bringing an additional genset online.

Similar, if the genset capacity needed (actual load plus the spinning reserve request) on the AC bus will exceed the load depending stop threshold after the potential stopping of a genset, then the ECpvX will keep the gensets at the load depending stop threshold load to prevent the genset system from stopping down a genset.

Eventually if the load drops further and the genset capacity needed (actual load plus the spinning reserve request) on the AC bus will not exceed the load depending stop threshold after the potential stopping of a genset, then the ECpvX will, after the load depending stop delay expires, bring the gensets to their minimum operating load which will result in the genset system stopping down a genset.

The genset system should be set up to do load depending start/stop calculations in percentage. It is recommended to set the load depending start/stop thresholds in the

ECpvX a few percentage higher than they are set in the genset system. If the gensets are of different ratings, then the genset start priority should be set in the same order as the modbus ID meaning that the one with the lowest Modbus ID has first priority and so on.

### Genset start/stop failures

On the same submenu level the setup page for genset start/stop failures are found. Clicking the up/down arrows will lead to it.

**ENcombi** ADMIN

**DG start fail.**

Fail. delay: 30.0 s

Enable: DISABLED

Auto ack.: DISABLED

**DG stop fail.**

Fail. delay: 30.0 s

Enable: DISABLED

Auto ack.: DISABLED

Genset start/stop failure setup page.  
 If genset start command is given and genset not on line within defined time a start failure is raised. That specific genset will not be considered available any longer until alarm is cleared. Manual alarm acknowledge will clear the alarm on all the gensets. Autoacknowledge will clear the alarm on all the gensets in case all gensets present are having start failure.  
 If genset stop command is given and genset not off line within defined time a stop failure is raised. In case stop failure is present all start commands are suppressed. All gensets must be off line before start command to new genset is given.

2020-07-10-13:46:24

If the genset start command is given and a genset is not on line within defined time a start failure is raised. That specific genset will not be considered available any longer until the alarm is cleared. Manual alarm acknowledgment will clear the alarm on all the gensets.

Auto acknowledge will clear the alarm on all the gensets in case all gensets present are having start failure.

If the genset stop command is given and the genset is not offline within defined time a stop failure is raised. In case stop failure is present all start commands are suppressed. All gensets must be offline before the ECpvX sends the start command to a new genset.

## Mains

### Measurements

Clicking the mains button leads to the page below where the measurements used for the grid can be set up.

The screenshot shows the ENcombi interface for 'Mains measurement setup'. On the left, there is a table of settings:

Measurement	
Sensing method:	SUM ALL PHASES
MB Feedb. origin:	FIXED ON
kW Origin:	MAINS METER
kWh Origin:	ECPVX

In the center, a text box titled 'Mains measurement setup page.' contains the following text:

Sensing method determines if to base reference on the sum of all phases, 3 x lowest loaded phase or 3 x sensing values.

MB feedback origin determines from which source the mains breaker position feedbacks arises.

kWh origin determines from which source the mains energy production arises.

At the bottom right of the screenshot, the timestamp '2023-12-06-09:36:37' is visible.

Sensing method determines what power readings to base the calculated references upon. Three options are available.

1. Sum all phases.
2. 3 x lowest phase.
3. 3 x sensing.

#### *Sum all phases*

The control will work on the total loading of all phases not regarding any potential asymmetry. Using this method with asymmetrical loads can in a self consumption situation for instance result in a situation where the net power feed to grid is in fact 0kW but there is import on some phase(s) and export on other phase(s).

#### *3 x lowest phases*

The control will identify the least loaded phase and multiply this with three. This can be useful when load is asymmetrical avoiding the situation described above. The net import power from the grid may not be 0kW but exporting power on any of the three phases is avoided.

#### *3 x sensing*

This can be used when load is symmetrical. Only one CT is installed, sensing the load from one phase only. The phase load sensed is representative for the loading on the other two phases. The ECpvX will multiply the load sensed with three in order to get the total load.



MB feedback origin determines from which source the mains breaker position closed feedbacks arises.

- Fixed on.
- Power meter.
- EClogic.
- All GB off
- Modbus page 03.
- ECsync

#### *Fixed on*

In case of sites without gensets where ECpvX is used for self consumption operation alone for example, the mains breaker position can always be assumed to be closed.

#### *Power meter*

In case a power meter is used the input1 of the power meter will be interpreted as mains breaker closed feedback.

#### *EClogic*

In more complex electrical infra structures having for instance sectional breakers separating the utility from the PV plant, a condition of whether the utility is at all connected to the same AC busbar section as the PV needs to be taken into consideration. Such conditions can be customized from within EClogic.

#### *All GB off*

In case all GBs are off and there is no genset communication alarm present, the ECpvX will interpret this as the mains breaker position is closed.

#### *Modbus page 03*

This will have ECpvX use the MB feedback data written from a superior controller/SCADA to the ECpvX proprietary modbus map page 3.

#### *ECsync*

This will have ECpvX use the external MB connected input to the ECsync cabinet.

kW origin determines from where to retrieve/calculate the grid power production. Supported methods are:

1. Mains meter.
2. Modbus page 03.
3. PV Comm.
4. Bat. Comm.
5. ECsync

#### *Mains meter*

Up to 16 power meters for sensing grid production can be installed. ECpvX will summarize the contributions from each of the meters into one common total for the grid power being imported/exported.

#### *Modbus page 03*

This will have ECpvX use the grid power data written from a superior controller/SCADA to the ECpvX proprietary modbus map page 3.

#### *PV Comm.*

Some vendors' inverters / inverter managers support data acquisition from a power meter installed at the grid connection. The ECpvX will acquire the active and reactive power readings from this meter via the PV communication.

#### *Bat Comm.*

This will have ECpvX use readings from the BESS system. It depends on the make and model of BESS whether this option is supported.

#### *ECsync*

The ECpvX will use the power readings of the ECsync cabinet.

kWh origin determines from where to retrieve/calculate the grid energy imported and exported. Supported methods are:

1. ECpvX.
2. Power meters

#### *ECpvX*

Based on the kW measured, the ECpvX integrates energy counters itself.

#### *Power meters*

The ECpvX will read the total energy counter from the power meters and summarize those.

ECpvX will, based on this, derive daily, monthly and yearly energy counters.

The meter used must provide both the total energy export counter and the total energy import counter in order to make use of this approach. Consult the Modbus master documentation on the ENcombi website for detailed information about what data is read from the various meter models.

<http://www.encombi.com/products/ECpvx/>

Note that all counters derived from energy counters remain linked to the ECpvX energy counters still.

## References PV

On the same submenu level, the setup page for references when parallel with PV is found. Clicking the up/down arrows will lead to it.

**References PV**

Mains P ctrl:	FIXED P
PREF:	20.0 kW
Mains Q ctrl:	FIXED Q
QREF:	0.0 kVAr
COSPHIREF:	1.000

**Mains reference setup page.**  
References applies for PV when running parallel to utility.

**Mains P ctrl determines the active power regulation scheme.**  
 Fixed P: the device will keep the active PV power production fixed.  
 Fixed P PCC: device will keep the active power production fixed at point of connection to utility.  
 PREF is used as reference by the Mains P ctrl scheme.

**Mains Q ctrl determines the reactive power regulation scheme.**  
 Fixed Q: the device will keep the reactive PV power production fixed.  
 Fixed Q PCC: device will keep the reactive power production fixed at point of connection to utility.  
 Fixed cosphi C or Fixed cosphi I: the device will keep the cosphi of the PV plant fixed running capacitive and inductive respectively.  
 Fixed cosphi C PCC or Fixed cosphi I PCC: the device will keep the cosphi at point of connection to utility fixed, capacitive and inductive respectively.  
 QREF and COSPHIREF are used as references by the Mains Q ctrl scheme.

2023-12-06-09:37:07

Mains P ctrl determines the active power regulation scheme.

- Fixed P: the device will keep the active PV power production fixed.
- Fixed P PCC: device will keep the active power production fixed at the point of connection to utility. This is therefore to be the selected method for doing self consumption / zero export operation.

PREF is used as the reference setting by the Mains P ctrl scheme.

Mains Q ctrl determines the reactive power regulation scheme.

- Fixed Q: the device will keep the reactive PV power production fixed.
- Fixed Q PCC: device will keep the reactive power production fixed at the point of connection to utility.
- Fixed cosphi C or Fixed cosphi I: the device will keep the cosphi of the PV plant fixed running capacitive and inductive respectively.
- Fixed cosphi C PCC or Fixed cosphi I PCC: the device will keep the cosphi at point of connection to utility fixed, capacitive and inductive respectively.
- Same cosphi: the device will keep the same cosphi between the PV plant and the utility.

QREF and COSPHIREF are used as reference settings by the Mains Q ctrl scheme.

## References Battery

On the same submenu level the setup page for references when parallel with the battery is found. Clicking the up/down arrows will lead to it.

**ENcombi** ADMIN

**References Battery**

Mains P ctrl:	SYSTEM P
PREF:	20.0 kW
Mains Q ctrl:	SYSTEM Q
QREF:	0.0 kVAr
COSPHIREF:	1.000

**Mains reference setup page.**  
References applies for the battery when running parallel to utility.

**Mains P ctrl determines the active power regulation scheme.**  
Fixed P: the device will keep the active battery power production fixed.  
System P: device will follow the mode selection made for the PV.  
PREF is used as reference by the Mains P ctrl scheme.

**Mains Q ctrl determines the reactive power regulation scheme.**  
Fixed Q: the device will keep the reactive battery power production fixed.  
Fixed cosphi C or Fixed cosphi I: the device will keep the cosphi of the battery fixed running capacitive and inductive respectively.  
System Q: device will follow the mode selection made for the PV.  
QREF and COSPHIREF are used as references by the Mains Q ctrl scheme.

2023-12-06-09:37:33

Mains P ctrl determines the active power regulation scheme.

- System P: The device will follow the mode selection from PV.
- Fixed P: The device will keep the active battery power production fixed while still following the various charge schemes.
- Fixed P SA: The device will keep the active battery power production fixed. It will disregard the various charge schemes. Both negative and positive references are accepted. Only the outer limits for low and high SOC are respected.
- Fixed P PCC SA: The device will keep import/export from the grid fixed. It will disregard the various charge schemes. Both negative and positive references are accepted. Only the outer limits for low and high SOC are respected.

PREF is used as the reference setting by the Mains P ctrl scheme.

Mains Q ctrl determines the reactive power regulation scheme.

- Fixed Q: the device will keep the reactive Battery power production fixed.
- Fixed cosphi C or Fixed cosphi I: the device will keep the cosphi of the Battery fixed running capacitive and inductive respectively.
- System Q: the device will follow the mode selection from PV.

QREF and COSPHIREF are used as reference settings by the Mains Q ctrl scheme.

## API

On the same submenu level the setup page for API setup is found. Clicking the up/down arrows will lead to it.

The ECpvX can take in various commands including power and reactive power commands for both PV and BESS via ECapi. This enables an online optimizer service provider to control the PV and BESS via ECapi thereby eliminating the need for installing any additional HW on site. The API setting must be enabled in order to have the ECpvX accepting commands applied via ECapi. Consult the ECapi documentation on which commands are available and how to apply them.

## Tariffs

On the same submenu level the setup page for utility tariffs are found. Clicking the up/down arrows will lead to it.

Import is used for calculating expense for the energy imported by the utility as well as for the import savings generated by the PV plant.

Export is used for calculating earnings for the energy exported to the utility.

Emission is used for calculating the CO2 emission savings due to the PV power produced while parallel to the grid.

For some European markets the tariffs can be based on the hourly market spot prices. The spot price will apply for both import and export tariffs. Pick the relevant market and enable the spot price to activate it. The spot price market works in Euro and the exchange rate between Euro and the local currency must be keyed in separately.

If arbitrage control based on the spot prices is used, then the cost factor for a full charge in Euro can be set. The charge cost factor can be thought of as a sensitivity factor for the arbitrage routine. The arbitrage control itself is enabled by the dedicated setting. Arbitrage control references will overrule the charge/discharge references originating from the normal mode operations and the associated settings in the Battery Charge and Dispatch menus. Still the transformer limits will overrule any arbitrage control references that exceed them.

## Rated sizes

On the same submenu level the setup pages for gensets rated power are found. Clicking the up/down arrows will lead to them.

ENcombi ADMIN

**Rated**

Mains 1:	100.0 kW
Mains 2:	100.0 kW
Mains 3:	100.0 kW
Mains 4:	100.0 kW
Mains 5:	100.0 kW
Mains 6:	100.0 kW
Mains 7:	100.0 kW
Mains 8:	100.0 kW

Mains capacity setup page.

2023-12-06-09:40:59

A total of 16 utility connections are supported. Above page is one of two pages available for setting up the rated mains transformer sizes.

## Counters

On the same submenu level pages for various utility related counters are found. Clicking the up/down arrows will lead to them.

- Imported energy (daily, monthly, yearly and total).

- Exported energy (daily, monthly, yearly and total).
- Import expense (daily, monthly, yearly and total).
- Export revenue (daily, monthly, yearly and total).

Below is an example.

The counters will be incremented automatically by the ECpvX in accordance with operation conditions. The counters are part of the counters backup discussed in the Identifier chapter.

The menus are only providing the possibility for manually presetting of the counters. Counters with a check mark in the update column will be preset with the keyed in value when the save button is pressed. Toggle between check mark and cross mark by pressing the respective button.

## Meter

Clicking the power meter button on the right hand side of any of the above pages leads to mains meter configuration. The mains meter configuration is done in the exact same manner as the already covered PV power meter configuration. Refer to PV power meter configuration for setting up of power meters.

## Grid management

Clicking the grid management button on the right hand side of any of the above pages leads to grid management configuration.

### Grid management

Backup in Off mode:	DISABLED
Connect threshold:	20.0 %
Disconnect threshold:	80.0 %
Genset backup:	DISABLED
Open point:	3.0 %
Grid breaker:	NON-SYNC
Enable:	DISABLED



Grid management setup page.

**Backup offgrid:**  
The grid can be used as a backup grid if the system are running off grid. When selecting this parameter, the grid will be available if genset fails or the Battery is low SOC.  
The grid will only be used as a backup if parameter is enabled.

**SOC Threshold:**  
Setup the SOC threshold for connecting and disconnecting the grid. When SOC goes below the limit for connecting grid, the grid will connect.  
When the battery is charged above the "disconnect threshold" the grid will disconnect again.

**MB open point:**  
Unload MB when transition from On-grid to Off-grid  
Percentage of rated power for open point.  
Sync type: Non-sync or Sync.

2021-08-24-15:11:28

### *Backup in off mode:*

If backup in off mode is enabled, the grid will act as backup for the battery. If the SOC drops below the selected threshold or the battery is blocked for operation, the grid will close and backup the battery. If the SOC goes above the selected threshold or the battery is able to start again, the grid will open again.

### *Breaker settings:*

Selecting between synchronizing grid breaker or non-sync grid breaker. The ECpvX is not in control of synchronizing breakers, but it will give a close signal to the grid and if the breakers are synchronized breakers, the battery will continue running and if the protocol supports adjust frequency and voltage output of the battery inverter to match the frequency and voltage of the grid.

If the breakers are non-sync, the battery will stop down and make a blackout in order to close the grid breaker.

In order to open the grid breaker, the ECpvX will unload the grid breaker and wait for the power to be less than the open point setting before sending an open signal to the grid.

### *Grid backup:*

If the genset is in genset mode and there is a genset failure, the grid can act as backup if the battery is not allowed. The grid will close and carry the load until the genset is ready again.



## Grid connect

On the same submenu level, the setup page for grid connect is found. Clicking the up/down arrows will lead to it.

ENcombi

ADMIN

## Grid Connect

Low voltage: 380.0 V

High voltage: 420.0 V

Low frequency: 49.5 Hz

High frequency: 50.5 Hz

Delay: 5.0 s

Enable: DISABLED

## Connect failure

Delay: 10.0 s

Enable: DISABLED



Grid connect setup page.

Voltage:  
Setup upper and lower thresholds for detecting grid failure.

Frequency:  
Setup upper and lower thresholds for detecting grid failure.

Delay:  
Time for accepting the grid as good.

Enable:  
Enable to make the ECpvx control the close and open of the breaker if grid failure.

2021-08-25-13:12:53

*Grid connect:*

It is possible to set up a threshold for detecting if the grid is available to connect. If the grid is out of voltage or frequency, the ECpvX will not send a close signal to the grid. When the grid is healthy again and within the range of voltage and frequency, the timer will start and after the timer expires, the ECpvX will send a close signal. If the grid fails within the timer, it will reset the timer and wait for the grid to become healthy again.

*Connect failure:*

If the ECpvX is sending a close signal to the grid and the feedback is not changing within the time period, the ECpvX will raise an alarm.

## Grid disconnect

On the same submenu level, the setup page for grid connect is found. Clicking the up/down arrows will lead to it.

ENcombi

ADMIN

## Grid Disconnect

Low voltage: 380.0 V

High voltage: 420.0 V

Low frequency: 49.5 Hz

High frequency: 50.5 Hz

Delay: 5.0 s

Enable: DISABLED

## Disconnect failure

Delay: 10.0 s

Enable: DISABLED



Grid disconnect setup page.

Voltage:  
Setup upper and lower thresholds for detecting grid failure.

Frequency:  
Setup upper and lower thresholds for detecting grid failure.

Delay:  
Time for accepting the grid as good.

Enable:  
Enable to make the ECpvx control the close and open of the breaker if grid failure.

2021-08-25-13:14:16

*Grid disconnect:*

It is possible to set up a threshold for detecting if the grid fails. If the grid fails, the ECpvX will send an open signal to the grid after the timer has expired.

If the grid becomes healthy within the time period, it will reset the timer.

*Disconnect failure:*

If the ECpvX is sending an open signal to the grid and the feedback is not changing within the time period, the ECpvX will raise an alarm.

## Grid support

Clicking the grid support button on the right hand side of any of the above pages leads to grid support configuration.

### P(f)

Dedicated frequency support menus exist for PV and battery respectively. Below is the menu for PV shown. The menu for Battery is identical.

#### ENcombi

ADMIN

##### Grid support P(f) PV

Deadband low:	49.00 Hz
Slope low:	10.00 kW/Hz
Cutoff low:	48.00 Hz
Deadband high:	51.00 Hz
Slope high:	-10.00 kW/Hz
Cutoff high:	52.00 Hz
Trigger	ENABLED
Enable:	DISABLED



P(f) grid support setup page  
 When grid frequency is within defined deadband the power reference is unaffected by the grid support.  
 When frequency goes above or below the deadband the reference is altered according to the frequency and the respective slopes. Frequencies above or below cutoff thresholds do not contribute to further alteration.  
 Once frequency returns within the defined deadband, the references are again passed by without interference from the grid support.  
 When the trigger setting is enabled the power level at the time the P(f) is triggered will be used as the baseline reference. Otherwise zero will be used.

2024-04-30-07:14:11

When the grid frequency is within the defined deadband, the power reference is unaffected by the grid support. When the frequency goes above or below the deadband, the power reference is then altered according to the frequency and the respective slopes. Frequencies above or below cutoff thresholds do not contribute to further alteration. Once frequency returns within the defined deadband, the references are again passed by without interference from the frequency support.

The power production at the time frequency exceeds the dead band and frequency support is triggered can be used as a baseline reference for the frequency support. This is enabled by the trigger setting. If the trigger setting is disabled, then zero kW is used as baseline.

Frequency support control references will overrule the charge/discharge references originating from the normal mode operations and the associated settings in the Battery Charge and Dispatch menus. Still the transformer limits will overrule any frequency support control references that exceed them.

Note that when grid power origin is set to "Mains meter" the Line1 frequency needs to be part of the data read from the mains meter in order to use the frequency support. Consult the Modbus master documentation on the ENcombi website for detailed information about what data is read from the various meter models.

<http://www.encombi.com/products/ecpvx/>

U(Q)

On the same submenu level the setup pages for voltage support are found. Clicking the up/down arrows will lead to them. Dedicated voltage support menus exist for PV and battery respectively. Below is the menu for PV shown. The menu for Battery is identical.

ENcombi

ADMIN

## Grid support Q(U) PV

Deadband low:	390.0 V
Slope low:	10.00 kVAr/V
Cutoff low:	380.0 V
Deadband high:	410.0 V
Slope high:	-10.00 kVAr/V
Cutoff high:	420.0 V
Trigger	ENABLED
Enable:	DISABLED



Q(U) grid support setup page.

When grid voltage is within defined deadband the reactive power reference is unaffected by the grid support.

When voltage goes above or below the deadband the reference is set equal to the PV reactive power at that instance.

The reference is then altered according to the voltage and the respective slopes. Voltages above or below cutoff thresholds do not contribute to further alteration.

Once voltage returns within the defined deadband, the references are again passed by without interference from the grid support.

When the trigger setting is enabled the reactive power level at the time the Q(U) is triggered will be used as the baseline reference. Otherwise zero will be used.



2024-04-30-07:14:34

When the grid voltage is within the defined deadband the reactive power reference is unaffected by the grid support. When voltage goes above or below the deadband the reference is then altered according to the voltage and the respective slopes. Voltages above or below cutoff thresholds do not contribute to further alteration.

Once voltage returns within the defined deadband, the references are again passed by without interference from the voltage support. Voltage support can be enabled for PV and Battery power respectively.

The reactive power production at the time voltage exceeds the dead band and voltage support is triggered can be used as a baseline reference for the voltage support. This is enabled by the trigger setting. If the trigger setting is disabled, then zero kVAr is used as baseline.

Voltage support control references will overrule the references originating from the normal mode operations

Note that when grid power origin is set to "Mains meter" that Line1-Line2 voltage needs to be part of the data read from the mains meter in order to use the voltage support. Consult the Modbus master documentation on ENcombi website for detailed information about what data is read from the various meter models.

<http://www.encombi.com/products/ecpvx/>

## Advanced grid support

On any of the Grid support pages, clicking on the command button leads to the advanced grid support options.

### Over Voltage

The first advanced grid support setting is cosphi reference overwrite during over voltage.

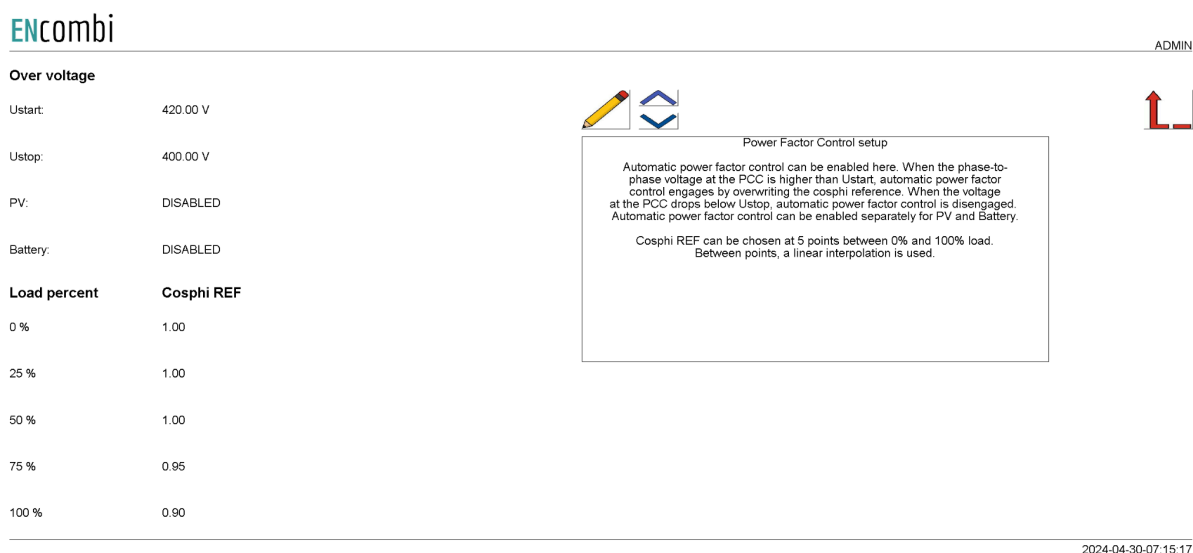

The screenshot shows the ENcombi web interface. At the top left is the ENcombi logo, and at the top right is the word 'ADMIN'. The main content area is titled 'Over voltage' and contains a table with the following settings:

Ustart:	420.00 V
Ustop:	400.00 V
PV:	DISABLED
Battery:	DISABLED
<b>Load percent</b>	<b>Cosphi REF</b>
0 %	1.00
25 %	1.00
50 %	1.00
75 %	0.95
100 %	0.90

Overlaid on the right side of the table is a 'Power Factor Control setup' dialog box. It contains the following text:

Automatic power factor control can be enabled here. When the phase-to-phase voltage at the PCC is higher than Ustart, automatic power factor control engages by overwriting the cosphi reference. When the voltage at the PCC drops below Ustop, automatic power factor control is disengaged. Automatic power factor control can be enabled separately for PV and Battery.

Cosphi REF can be chosen at 5 points between 0% and 100% load. Between points, a linear interpolation is used.

At the bottom right of the screenshot, the date and time '2024-04-30-07:15:17' are displayed.

This setting starts to overwrite the cosphi reference when the grid voltage measured by the mains meter exceeds Ustart, and stops overwriting the cosphi reference once the grid voltage drops below Ustop.

The setting can be enabled for PV and Battery separately.

When active, the cosphi reference follows a curve based on the active power loading of the corresponding inverter. The cosphi reference can be chosen at 5 points between 0% and 100% load percent. In between points a linear interpolation is used.

### Under Frequency

The second advanced grid support option disables ramping down the active power during under frequency. The page for this setting can be reached by clicking the up/down arrow.

**Under Frequency**

PV: DISABLED  
 Battery: DISABLED



Under frequency disable ramp down  
 When enabled, and the grid frequency is under 50 Hz the ramp down of active power is disabled.  
 This setting can be enabled for PV and Battery separately.

2024-04-30-07:24:52

The under frequency setting can be enabled for PV and Battery separately. When enabled, the active power is prohibited from ramping down while the frequency is under 50 Hz.

## Load

Clicking the sensor button leads to the following page.

**Load power meter**

DG load meter: 0  
 PV load meter: 0  
 Mains load meter: 0



Load power meter setup page.  
 A maximum of 48 power meters for load is supported.  
 Load meters are divided into three groups, each with a maximum of 16 meters.  
 The three groups share the protocol and ID range with the source meters for PV, DG and Mains respectively.  
 Group1 shares with DG, Group2 shares with PV and Group3 shares with Mains.  
 The number of load meter plus the number of source meters for each group can be a maximum of 16 meters.

2022-04-06-10:25:25

Above page there are 3 options to select load power meters. If the DG load meter is selected, the power meter protocol is selected on the DG power meter page. The ID of the load meter will be the next ID after the DG power meter.

If selecting PV or mains load meter, it is the same philosophy. The protocol is selected on the DG, PV or mains power meter setup page.

*Example with the same power meter model:*

2 x DG power meters with ID 3 and 4.

1 x load power meter with ID 5.

Under the DG power meter setup page the specific power meter protocol is selected and ID 3 is set as ID and the number of power meters is set to 2. Then the user needs to select 1 load power meter in the DG load meter setting. Then the user is able to see data from alle 3 power meters; the first 2 power meters are from DG and the third is from the load meter.

*Example with different power meter models:*

2 x DG power meters with ID 3 and 4.

1 x load power meter with ID 5.

Under the DG power meter setup page the specific power meter protocol is selected and ID 3 is set as ID and the number of power meters is set to 2.

The load power meter is another protocol than the DG power meter protocol, so the user will need to configure a PV power meter with the correct protocol. On the setup page the user will type in 0 as the number of PV power meters and the ID must be the load power meter ID, which is 5.

Then go to the load power meter setup page and select 1 meter for the PV load power meter setting.

## Load meter for control

Clicking the Advanced button to the right hand side will lead to the menu below.

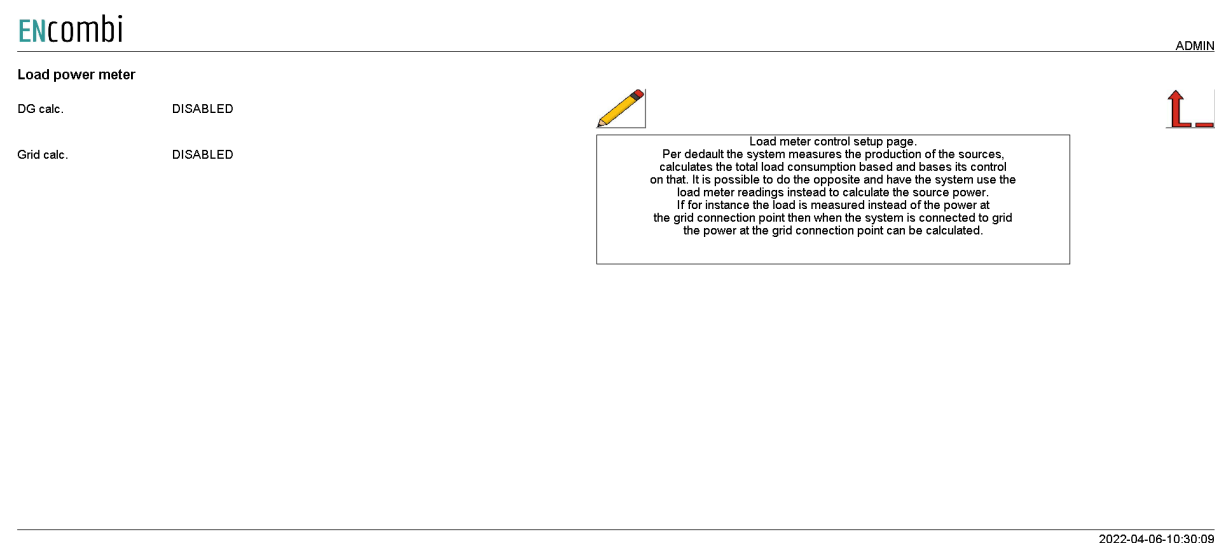

ENcombi ADMIN

Load power meter	
DG calc.	DISABLED
Grid calc.	DISABLED

**Load meter control setup page.**

Per default the system measures the production of the sources, calculates the total load consumption based and bases its control on that. It is possible to do the opposite and have the system use the load meter readings instead to calculate the source power.

If for instance the load is measured instead of the power at the grid connection point then when the system is connected to grid the power at the grid connection point can be calculated.

2022-04-06-10:30:09

Normally the total load in the system is a calculated value based on the production of the various sources (genset, PV, grid and battery) and the control is based on the readings from the sources directly. On this page it is possible to have the ECpvX use the readings from the load meters as an expression of the total loading in the system and use this for calculating the power flowing in/out of the grid when being parallel to the grid and the power production of the genset when being parallel to the genset respectively and do its control based upon that instead.

This can be useful in the various cases where for instance the grid meters can't be mounted due to physical constraints and only load meters are available or it could be a

simple ATS application with one genset and one grid, then the control can be based on a single meter placed on the load side of the ATS instead of having both a power meter for the genset and a power meter for the grid.





## Sensors

Clicking the sensor button leads to the following page.

ENcombi ADMIN

---

**Sensors**



POA origin:	OFF	  <div style="border: 1px solid black; padding: 5px; text-align: center; margin-top: 5px;"> <p>Meteorological setup page. Select the origin of the various meteorological readings. They origin can be from one of the sensors installed or directly from the PV communication.</p> </div>	
BOM origin:	OFF		
GHI origin:	OFF		
Amb. temp. origin:	OFF		
Wind speed origin:	OFF		
RH origin:	OFF		
Bar. press. origin:	OFF		
Wind dir. origin:	OFF		
Rain origin:	OFF		

2020-07-10-13:41:50

ENcombi ADMIN

---

**Sensors**

Fuel Lvl 01 origin:	OFF	  <div style="border: 1px solid black; padding: 5px; text-align: center; margin-top: 5px;"> <p>Fuel level setup page. Select the origin of the various fuel level readings. They origin can be from one of the sensors installed, directly from the PV communication or by Modbus Page 3.</p> </div>	
Fuel Lvl 02 origin:	OFF		
Fuel Lvl 03 origin:	OFF		
Fuel Lvl 04 origin:	OFF		
Fuel Press 01 origin:	OFF		
Fuel Press 02 origin:	OFF		
Fuel Press 03 origin:	OFF		
Fuel Press 04 origin:	OFF		

2022-04-06-13:24:58

Above page holds the list of all meteorological readings supported. The origin of these readings can be selected as either Modbus RTU based sensors, inverter communication, Modbus page 3 or by EClogic.

### Modbus RTU Sensors

On the same submenu level the page for setting up Modbus RTU sensor communication is found. Clicking the up/down arrows will lead to it.

### Sensors

COM port:	COM2
Sensor 1:	OFF
Sensor 1 ID:	1
Sensor 2:	OFF
Sensor 2 ID:	1
Sensor 3:	OFF
Sensor 3 ID:	1
Sensor 4:	OFF
Sensor 4 ID:	1



Sensor setup page.  
Sensor communication is running Modbus RTU only.  
Whether to use COM2 or COM3 is selectable by parameter.  
Port settings is setup at dedicated port setup page.

2020-07-10-13:42:10

Sensor communication runs on Modbus RTU only. Whether to use sensors on COM2 or COM3 is selectable by parameter. A maximum of 4 Modbus RTU sensors can be connected to the ECpvX.

Check the link below to see which sensors are supported by ECpvX.

<http://www.encombi.com/products/ecpvx/>

### PV generating capacity

On the same submenu level the page for calculating the generating capacity (GC) of the PV panels is found. Clicking the up/down arrows will lead to it.

### Sensors

Panel temp. coef.:	-0.41 %/C
Degradation:	0.0 %/year
Year:	2022
DC loss:	0.0 %
Inv. efficiency:	100.0 %
AC loss:	0.0 %
BOM Offset:	0.0 C
GC compensation:	OFF



PV generating capacity setup page.  
Panel temperature coefficient can be keyed in.  
Based on POA and BOM, generating capacity compensation of the PV panels installed can be calculated. Furthermore can the panel degradation factor, DC loss factor, inverter efficiency and AC loss factor be keyed in to get the generating capacity on the AC side.  
The device uses the the generating capacity on the AC side for handling curtailment counters and PV performance ratios. In case generating capacity compensation is not enabled, installed PV panel capacity will be used as PV generating capacity by device.

2022-09-30-09:41:38

GC compensation selection determines if and how to do generating capacity compensation of the PV panels. The ECpvX uses PV panel generating capacity for handling curtailment counters and PV performance ratios. Supported methods are:

1. Disabled.
2. Sensors.
3. Modbus page 03.

*Disabled*

In this case the installed PV panel capacity will be used as PV generating capacity by the ECpvX.

*Sensors*

Based on the keyed-in Installed PV panel capacity, the PV panel temperature coefficient, The PV panel degradation, DC losses, inverter efficiency, AC losses and the readings from the POA and BOM sensors, the generating capacity of the PV panels is calculated. The efficiency of the inverters is thereafter included to get the PV generating capacity.

*Modbus page 03*

This will have ECpvX use the PV generating capacity data written from a superior controller/SCADA to the ECpvX proprietary modbus map page 3.

*EClogic*

In EClogic it is possible to use the dedicated EClogic pages to set up the input to the data points.

## IO modules

Clicking the IO module button leads to the following page.

**ENcombi** VIEWER

**IO modules**

COM port:	COM2
IO 1:	OFF
IO 2:	OFF
IO 3:	OFF
IO 4:	OFF

IO module setup page.  
IO module communication can either run Modbus RTU or Modbus TCP.  
Whether to use COM2, COM3 or TCP is selectable by parameter.  
Port settings is setup at dedicated port setup page.

2021-01-22-17:11:09

Above page holds the setting up Modbus IO module communication. IO module communication runs either Modbus RTU or Modbus TCP. Whether to use IO modules on COM2, COM3 or TCP is selectable by parameter. A maximum of 4 Modbus IO modules can be connected to the ECpvX. The ECpvX can also read IO data directly from another ECpvX. This is selectable by parameter.

Check the link below to see which IO modules that are supported by ECpvX.

<http://www.encombi.com/products/ecpvx/>

Clicking the up/down arrows leads to the page below where the Modbus ID and IP addresses for the respective IO modules are set up.

**ENcombi** ADMIN

**IO modules**

IO 1 ID:	1
IO 1 IP:	192.168.1.50
IO 2 ID:	1
IO 2 IP:	192.168.1.50
IO 3 ID:	1
IO 3 IP:	192.168.1.50
IO 4 ID:	1
IO 4 IP:	192.168.1.50

IO module setup page.  
Modbus RTU ID of the IO modules is selectable by parameter.  
Modbus TCP IP of the IO modules is selectable by parameter.  
The Modbus ID selected is used in the TCP frames.

2021-01-24-11:56:05

## Analogue input/output

The ECpvX supports analogue input/output modules. When the analogue module is selected in the IO window setup, all settings are placed in the monitoring of the IO module.

ENcombi

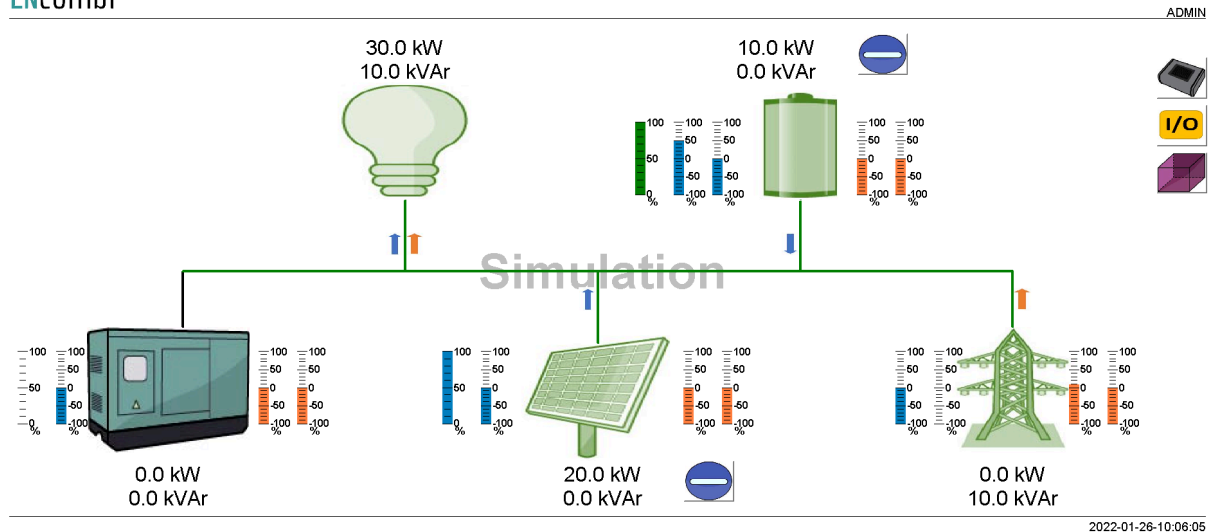

When pressing the IO button, it will lead to the following page.

ENcombi

IO modules	IO type	IO inputs	IO outputs	Communication state:	Communication enable:
IO 1:	EX04AIO	N.A	N.A		
IO 2:	EX04AIO	N.A	N.A		
IO 3:	EX1608DD	0011 0000 0000 1100	0000 0000 0000 0000		
IO 4:	EX04AIS	N.A	N.A		

2022-02-01-09:20:08

From this page it is possible to select which IO module to set up and monitor values. If the IO module is digital input/output, it is not possible to click on the module, the actual bit value is present at this page.

By clicking on the IOx module, it will lead to the following page.

IO2	AIO type	Value	PCT	Minimum Scale	Maximum Scale	State:
Channel 1:	INPUT	1500.0	36.6 %	0.0	4095.0	Normal 
Channel 2:	INPUT	2000.0	48.8 %	0.0	4095.0	Normal
Channel 3:	OUTPUT	0.0	0.0 %	0.0	4095.0	Normal
Channel 4:	OFF	N.A	N.A	0.0	4095.0	N.A

Module temp: 32.2 C

Communication state: 

2022-02-07-14:16:54

From this page it is possible to scale the input/output on each channel of the IO module. The input value can be used for Pref, Qref or other data points. This is set in EClogic. The value shown is the scaled value and the percentage is the percentage of the range from 0-100%. The maximum range is 0-4095. The module temperature is shown in the lower right corner and the state of each channel can be read to the right.

## Alarms

Clicking the alarm button leads to menus of customizable alarms.

- Genset low power.
- Mains low power.
- COM2 port slave alarm.
- COM3 port slave alarm.
- TCP port slave alarm.
- SOC minimum alarm
- SOC maximum alarm

Other alarms exist as well but they are not customizable alarms as the ones listed above.

## Genset low power

ENcombi

ADMIN

## DG low P

Threshold:	-5 %
Delay:	5.0 s
Enable:	DISABLED
Signal:	DISABLED
PV Action:	NOTIFICATION
Bat. Action:	NOTIFICATION
Auto ack.:	DISABLED



Genset low power alarm setup page.  
 When genset power is below the threshold the alarm condition is present.  
 When condition has been present for a periode equal to or longer than the delay and in case the alarm is enabled the alarm is provoked.  
 When alarm is provoked, the signal selected will be activated and the action selected will be taken.  
 The alarm is automatically acknowledged in case auto ack. is enabled.

2022-11-21-18:57:37

When the genset power is below the threshold, the alarm condition is present. When the condition has been present for a period equal to or longer than the delay and in case the alarm is enabled, the alarm is provoked. When the alarm is provoked, the signal selected will be activated and the action selected will be taken. The alarm is automatically acknowledged in case auto ack. is enabled.

## Signals available:

1. Relay01 on all PV meters
2. Relay02 on all PV meters
3. Relay01 on all genset meters
4. Relay02 on all genset meters
5. Relay01 on all mains meters
6. Relay02 on all mains meters

If to activate a relay on a specific meter only, then this can be made through EClogic.

## PV actions available:

1. Notification
2. Soft stop
3. Hard stop

Notification means populating an alarm and creating a log entry.

Soft stop and Hard stop will besides the notification also stop the PV plant. That being with power ramp down and without power ramp down respectively.

## Bat actions available:

4. Notification
5. Soft stop
6. Hard stop

Notification means populating an alarm and creating a log entry.  
 Soft stop and Hard stop will besides the notification also stop the ESS. That being with power ramp down (if connected to genset or grid - otherwise without) and without power ramp down respectively.

## Mains low power

**Mains low P**

Threshold:	-5 %
Delay:	5.0 s
Enable:	DISABLED
Signal:	DISABLED
PV Action:	NOTIFICATION
Bat. Action:	NOTIFICATION
Auto ack.:	DISABLED



Mains low power alarm setup page.  
 When mains power is below the threshold the alarm condition is present.  
 When condition has been present for a periode equal to or longer than the delay and in case the alarm is enabled the alarm is provoked.  
 When alarm is provoked, the signal selected will be activated and the action selected will be taken.  
 The alarm is automatically acknowledged in case auto ack. is enabled.

2022-11-21-18:58:12

When the mains power is below the threshold the alarm condition is present. When the condition has been present for a period equal to or longer than the delay and in case the alarm is enabled, the alarm is provoked. When the alarm is provoked, the signal selected will be activated and the action selected will be taken. The alarm is automatically acknowledged in case auto ack. is enabled.

## COM2 slave

**COM2 slave**

Delay:	5.0 s
Enable:	DISABLED
Signal:	DISABLED
PV Action:	NOTIFICATION
Bat. Action:	NOTIFICATION
Auto ack.:	DISABLED



COM2 slave alarm setup page.  
 When no frames are received from modbus master the alarm condition is present.  
 When condition has been present for a periode equal to or longer than the delay and in case the alarm is enabled, the alarm is provoked.  
 When alarm is provoked, the signal selected will be activated and the action selected will be taken.  
 The alarm is automatically acknowledged in case auto ack. is enabled.

2022-11-21-18:59:18

When no frames are received from the modbus RTU master, the alarm condition is present. When the condition has been present for a period equal to or longer than the delay and in case the alarm is enabled, the alarm is provoked. When the alarm is provoked, the signal selected will be activated and the action selected will be taken. The alarm is automatically acknowledged



in case auto ack. is enabled.

## COM3 slave

ENcombi

ADMIN

### COM3 slave

Delay: 5.0 s

Enable: DISABLED

Signal: DISABLED

PV Action: NOTIFICATION

Bat. Action: NOTIFICATION

Auto ack.: DISABLED



COM3 slave alarm setup page.  
 When no frames are received from modbus master the alarm condition is present.  
 When condition has been present for a periode equal to or longer than the delay and in case the alarm is enabled, the alarm is provoked.  
 When alarm is provoked, the signal selected will be activated and the action selected will be taken.  
 The alarm is automatically acknowledged in case auto ack. is enabled.



2022-11-21-18:59:38

When no frames are received from the modbus RTU master, the alarm condition is present. When the condition has been present for a period equal to or longer than the delay and in case the alarm is enabled, the alarm is provoked. When the alarm is provoked, the signal selected will be activated and the action selected will be taken. The alarm is automatically acknowledged in case auto ack. is enabled.

## TCP slave

ENcombi

ADMIN

### TCP slave

Delay: 5.0 s

Enable: DISABLED

Signal: DISABLED

PV Action: NOTIFICATION

Bat. Action: NOTIFICATION

Auto ack.: DISABLED



TCP slave alarm setup page.  
 When no frames are received from modbus master the alarm condition is present.  
 When condition has been present for a periode equal to or longer than the delay and in case the alarm is enabled, the alarm is provoked.  
 When alarm is provoked, the signal selected will be activated and the action selected will be taken.  
 The alarm is automatically acknowledged in case auto ack. is enabled.



2022-11-21-19:00:01

When no frames are received from the modbus TCP master, the alarm condition is present. When the condition has been present for a period equal to or longer than the delay and in case the alarm is enabled, the alarm is provoked. When the alarm is provoked, the signal selected will be activated and the action selected will be taken. The alarm is automatically acknowledged in case auto ack. is enabled.

## SOC minimum

ENcombi

ADMIN

### SOC minimum

Threshold:	5 %
Delay:	5.0 s
Enable:	DISABLED
Signal:	DISABLED
PV Action:	NOTIFICATION
Bat. Action:	NOTIFICATION
Auto ack.:	DISABLED



State of charge minimum alarm setup page.  
 When SOC goes below the threshold the alarm condition is present.  
 When condition has been present for a periode equal to or longer than the delay and in case the alarm is enabled the alarm is provoked.  
 When alarm is provoked, the signal selected will be activated and the action selected will be taken.  
 The alarm is automatically acknowledged in case auto ack. is enabled.

2022-11-21-19:00:22

When SOC goes below the threshold, the alarm conditions are present. When the condition has been present for a period equal to or longer than the delay and in case the alarm is enabled, the alarm is provoked. When the alarm is provoked, the signal selected will be activated and the action selected will be taken. The alarm is automatically acknowledged in case auto ack. is enabled.

## SOC maximum

ENcombi

ADMIN

## SOC maximum

Threshold:	90 %
Delay:	5.0 s
Enable:	DISABLED
Signal:	DISABLED
PV Action:	NOTIFICATION
Bat. Action:	NOTIFICATION
Auto ack.:	DISABLED



State of charge maximum alarm setup page.  
 When SOC goes above the threshold the alarm condition is present.  
 When condition has been present for a periode equal to or longer than the delay and in case the alarm is enabled the alarm is provoked.  
 When alarm is provoked, the signal selected will be activated and the action selected will be taken.  
 The alarm is automatically acknowledged in case auto ack. is enabled.

2022-11-21-19:00:42

When SOC goes above the threshold, the alarm conditions are present. When the condition has been present for a period equal to or longer than the delay and in case the alarm is enabled, the alarm is provoked. When the alarm is provoked, the signal selected will be activated and the action selected will be taken. The alarm is automatically acknowledged in case auto ack. is enabled.

## Cell voltage minimum

ENcombi

ADMIN

## Cell V minimum

Threshold:	3000 mV
Delay:	5.0 s
Enable:	DISABLED
Signal:	DISABLED
PV Action:	NOTIFICATION
Bat. Action:	NOTIFICATION
Auto ack.:	DISABLED



Cell voltage minimum alarm setup page.  
 When the lowest cell voltage goes below the threshold the alarm condition is present.  
 When condition has been present for a periode equal to or longer than the delay and in case the alarm is enabled the alarm is provoked.  
 When alarm is provoked, the signal selected will be activated and the action selected will be taken.  
 The alarm is automatically acknowledged in case auto ack. is enabled.

2022-12-16-00:02:46

When the lowest cell voltage goes below the threshold, the alarm conditions are present. When the condition has been present for a period equal to or longer than the delay and in case the alarm is enabled, the alarm is provoked. When the alarm is provoked, the signal selected will be activated and the action selected will be taken. The alarm is automatically acknowledged in case auto ack. is enabled.

## Cell voltage maximum

ENcombi

ADMIN

### Cell V maximum

Threshold:	3500 mV
Delay:	5.0 s
Enable:	DISABLED
Signal:	DISABLED
PV Action:	NOTIFICATION
Bat. Action:	NOTIFICATION
Auto ack.:	DISABLED



Cell voltage maximum alarm setup page.  
 When the highest cell voltage goes above the threshold the alarm condition is present.  
 When condition has been present for a periode equal to or longer than the delay and in case the alarm is enabled the alarm is provoked.  
 When alarm is provoked, the signal selected will be activated and the action selected will be taken.  
 The alarm is automatically acknowledged in case auto ack. is enabled.

2022-12-16-00:03:12

When the highest cell voltage goes above the threshold, the alarm conditions are present. When the condition has been present for a period equal to or longer than the delay and in case the alarm is enabled, the alarm is provoked. When the alarm is provoked, the signal selected will be activated and the action selected will be taken. The alarm is automatically acknowledged in case auto ack. is enabled.

## Fuel level alarm

ENcombi

ADMIN

### Fuel Level alarm

Threshold:	20 %
Delay:	5.0 s
Enable:	DISABLED
Signal:	DISABLED
PV Action:	NOTIFICATION
Bat. Action:	NOTIFICATION
Auto ack.:	DISABLED



Fuel level alarm setup page.  
 When Fuel level goes below the threshold the alarm condition is present.  
 When condition has been present for a periode equal to or longer than the delay and in case the alarm is enabled the alarm is provoked.  
 When alarm is provoked, the signal selected will be activated and the action selected will be taken.  
 The alarm is automatically acknowledged in case auto ack. is enabled.

2022-11-21-19:01:04

When fuel level goes below the threshold, the alarm conditions are present. When the condition has been present for a period equal to or longer than the delay and in case the alarm is enabled, the alarm is provoked. When the alarm is provoked, the signal selected will be activated and the action selected will be taken. The alarm is automatically acknowledged in case auto ack. is enabled.

## Inverter production deviation alarm

ENcombi

ADMIN

## Inv deviation alarm

Threshold:	5.0 kW
Delay:	600 s
Enable:	DISABLED
Signal:	DISABLED
PV Action:	NOTIFICATION
Bat. Action:	NOTIFICATION
Auto ack.:	ENABLED



Inverter production deviation alarm setup page.  
When the difference between the highest and lowest power produced by the inverter goes above the threshold the alarm condition is present.  
When condition has been present for a periode equal to or longer than the delay and in case the alarm is enabled the alarm is provoked.  
When alarm is provoked, the signal selected will be activated and the action selected will be taken.  
The alarm is automatically acknowledged in case auto ack. is enabled.

2022-11-21-19:01:22

This alarm monitors the spread in production amongst the inverters. When the difference between the highest producing inverter and the lowest producing inverter goes above the threshold, the alarm conditions are present. When the condition has been present for a period equal to or longer than the delay and in case the alarm is enabled, the alarm is provoked. When the alarm is provoked, the signal selected will be activated and the action selected will be taken. The alarm is automatically acknowledged in case auto ack. is enabled.

## Common master communication

ENcombi

ADMIN

## Comm alarm

Delay:	60.0 s
Enable:	ENABLED
Signal:	DISABLED
PV Action:	NOTIFICATION
Bat. Action:	NOTIFICATION
Auto ack.:	ENABLED



Common modbus master communication alarm setup page.  
When any modbus master communication alarm is triggered, then the alarm condition is present.  
When the condition has been present for a periode equal to or longer than the delay, and in case the alarm is enabled, the alarm is provoked.  
When the alarm is provoked, the signal selected will be activated and the action selected will be taken.  
The alarm is automatically acknowledged in case auto ack. is enabled.

2022-11-21-19:01:49

This alarm condition is present in case any of the modbus master communication alarms for the inverter, power meter, sensor or IO communication are raised. When the condition has been present for a period equal to or longer than the delay and in case the alarm is enabled, the alarm is provoked. When the alarm is provoked, the signal selected will be activated and the action selected will be taken. The alarm is automatically acknowledged in case auto ack. is enabled.

## Modbus Master comm. alarms

ENcombi

ADMIN

### Master alarms

Power meter:	10
Inverter:	10
Bat inverter:	10
BMS:	10
HVAC:	10
Sensor:	10
IO:	10



Modbus master communication alarm setup page.  
 The number of timeouts to encounter before the respective alarm is raised can be set here. This way the sensitivity of the various Modbus Master related communication alarms can be adjusted. Mail and FTP transfer are suppressed in case the respective timeout is set lower than the value of 10. Inhibit of inverter communication alarm can be enabled based on night time and irradiance respectively.

2023-04-18-09:03:00

ENcombi

ADMIN

### Master alarms

Inhibit night:	DISABLED
Inhibit POA:	DISABLED
POA threshold:	20 W/m2



Modbus master communication alarm setup page.  
 The number of timeouts to encounter before the respective alarm is raised can be set here. This way the sensitivity of the various Modbus Master related communication alarms can be adjusted. Mail and FTP transfer are suppressed in case the respective timeout is set lower than the value of 10. Inhibit of inverter communication alarm can be enabled based on night time and irradiance respectively.

2023-04-18-09:03:20

Here the sensitivity of the Modbus Master communication alarms can be adjusted. The settings dictates the number of timeouts to encounter before the respective Modbus Master alarm is raised. Furthermore it is possible to inhibit the inverter related communication alarms based on night time conditions and/or low irradiance.

## Overview

When all settings are made, clicking the overview button leads to the below page providing a quick overview of the configuration made including protocols, baud rates, IDs/IPs selected for inverter, meters and sensors etc.

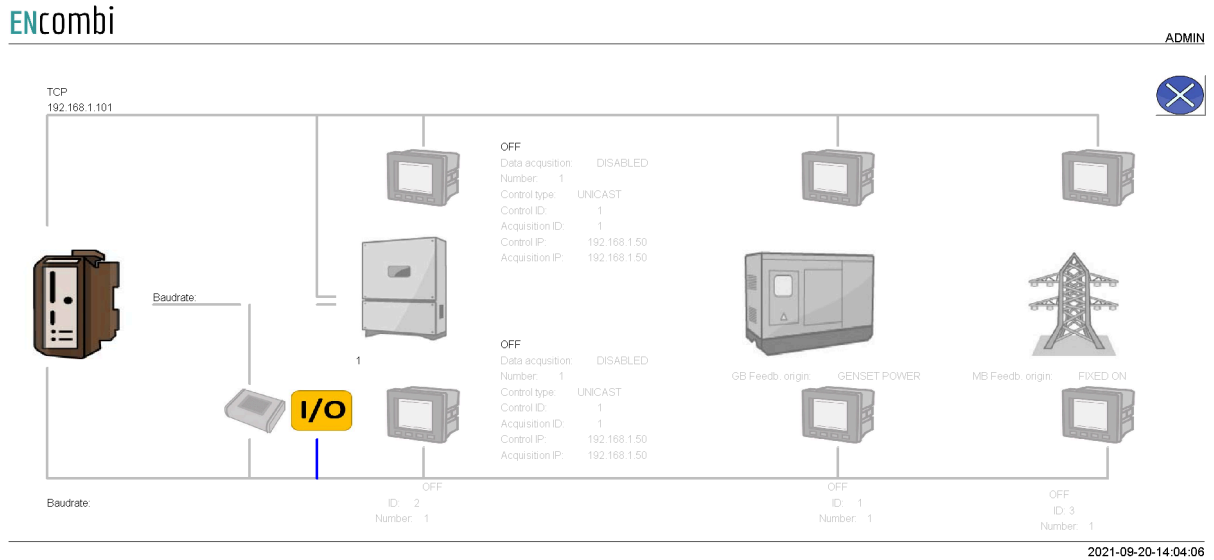



## Nighttime

Clicking the Nighttime button leads to the page below where the nighttime period can be defined.

ENcombi ADMIN

---

Night time

Start hour:	18 h		
Start minute:	0 min	<div style="border: 1px solid black; padding: 5px; text-align: center;">Night time setup page. Here the night time period can be defined using the night time start and night time stop settings.</div>	
Stop hour:	6 h		
Stop minute:	0 min		

2020-07-10-13:51:58

Whether the nighttime or daytime period is active, it can be used for switching the P/Q priority of the PV plant for instance.



## Simulation

Clicking the simulation button leads to the page below where the simulation mode can be enabled/disabled.

ENcombi ADMIN

Simulation

Simulation: ENABLED

Simulation setup page.

Simulation enables you to try out the ECpv in an office environment without the need of being connected to any real equipment. When simulation is enabled a button will appear on the overview page. Here various stimuli like active and reactive loads can be applied. Run through the various control schemes and see their behaviour. Check out how data on plant level to component level is visualised.

Additional settings required when using simulation:

- 1) GB feedback origin: Meter communication.
- 2) Gesent kW origin: Genset Meter.
- 3) MB feedback origin: Meter communication.
- 4) Mains kW origin: Mains meter.
- 5) PV kW origin: PV meter or Inverter Acquisition.
- 6) Inverter control: Enable.
- 7) Inverter acquisition: Enable.

Communication towards power meters, inverters etc. must be disabled. The number of power meters and inverters selected will however reflect on the visualization as in real operation. Also the rated size set up for the PV plant, genset etc. will have the normal impact.

2020-07-10-13:52:18

Simulation enables you to try out the ECpvX in an office environment without the need of being connected to any real equipment. When simulation is enabled, a button will appear on the monitoring overview page. Here various stimuli like active and reactive loads can be applied. Run through the various control schemes and see their behavior. Check out how data on plant level to component level is visualized.

Additional settings required when using simulation:

- 1) GB feedback origin: Meter communication.
- 2) Gesent kW origin: Genset Meter.
- 3) MB feedback origin: Meter communication.
- 4) Mains kW origin: Mains meter.
- 5) PV kW origin: PV meter or Inverter Acquisition.
- 6) Battery kW origin: Inverter Acquisition.
- 7) Inverter control: Enable.
- 8) Bat Inverter control: Enable.
- 9) Inverter acquisition: Enable.
- 10) Bat Inverter acquisition: Enable.

Furthermore, communication towards power meters, inverters etc. must be disabled. The number of power meters and inverters selected will however reflect on the visualization as in real operation. Also the rated size set up for the PV plant, genset etc. will have the normal impact.

## Proprietary modbus pages

Clicking the pages button leads to the following page.

ENcombi ADMIN

Pages	
Proprietary slave:	ENABLED
Page 1:	ENABLED
Page 2:	ENABLED
Page 3:	DISABLED
Page 4:	ENABLED
Page 5:	DISABLED
Page 6:	DISABLED

**Modbus slave page config.**  
 In case Proprietary slave is enabled, the device will accept references etc. received from a Modbus master. The individual proprietary pages can be enabled here. Consult the Modbus Slave documentation to learn the content of each page.

2024-03-12-11:32:11

In case Proprietary slave is enabled, the ECpvX will accept instructions to be received over modbus via a dedicated proprietary modbus profile. The various instructions are furthermore grouped together in different pages that need to be enabled individually. Consult the Modbus slave documentation on ENcombi website for detailed information about the proprietary modbus profile.

<http://www.encombi.com/products/ECpvx/>

Clicking the up/down arrows leads to the page below where various Modbus slave functionalities can be enabled.

ENcombi ADMIN

SunSpec slave:	DISABLED
ECpvX slave:	DISABLED
ECgrid slave:	DISABLED

**Modbus slave config.**

In case SunSpec slave is enabled, the device will accept references received from a SunSpec master.

In case ECpvX slave is enabled, the device will accept references received from an ECpvX Cluster.

In case ECgrid slave is enabled, the device will accept references received from an ECgrid.

2024-03-12-12:06:54

In case SunSpec slave is enabled, the ECpvX will accept references received from a SunSpec master.

In case ECpvX slave is enabled, the ECpvX will accept references received from a ECpvX Cluster controller.

In case ECgrid slave is enabled, the ECpvX will accept references received from an ECgrid controller.

Clicking the button on the right hand side leads to the Configurable Modbus area page.

Here it is possible to tailor your own modbus mapping. Data elements that are scattered around the standard modbus map (function code 0x04 ) can be mapped and concentrated to the Configurable Modbus area.

## Monitoring

Clicking the monitoring button leads to the following page.

Monitoring on ECweb will by default only display the Genset and Grid power and the Load consumption that is connected to the same busbar as the PV and battery. The

same applies for the Modbus and subsequently the ECpanel and ECcloud. Also the energy counters and its derivatives will only increment based on the Genset and Grid power generated when connected to the same busbar as the PV and battery. With the designated "Monitoring total" setting this can be changed so the total values measured are used instead throughout it all.

## ECsync

### Synchronization and deload

Clicking the ECsync cabinet button leads to the below page where the synchronization and breaker open thresholds parameters are set up.

ENcombi

ADMIN

ECsync Sync.

Offset F	0.15 Hz
Offset V	5.0 V
Open point	3.0 %

ECsync synchronization setup page.  
When synchronizing, the ECpVX will use the sensed ECsync grid readings minus the voltage and frequency offsets as the target references for the BESS.  
When going to off grid operation the ECsync will be unloaded initially and first open its breaker when the loading is below the open. The open point threshold refers to the rating of the PCS.

2023-10-02-10:54:55

When synchronizing, the ECpVX will use the sensed ECsync grid readings minus the voltage and frequency offsets as the target references for the BESS. When going to off grid operation the ECsync will be unloaded initially and first open its breaker when the loading is below the open threshold point. The open point threshold refers to the rating of the PCS.

### ECsync communication setup

On the above ECsync page clicking the ECsync cabinet button will lead to the below page for selecting the ECsync cabinet relay protocol to use.

## ECsync

Protocol:	OFF
Modbus type:	TCP
Control Fnc:	0x10
Control:	ENABLED
Data acquisition:	ENABLED



ECsync setup page.  
The device can interface to the ECsync cabinet via Modbus RTU or Modbus TCP.  
The data read from the ECsync cabinet will be visualized on a dedicated page.  
Enable the Control if to use the dry contact outputs from the cabinet and send manual commands like mode change, breaker open/close etc. to the ECsync cabinet.

2023-10-02-11:05:28

A maximum of 1 ECsync cabinet is supported by a single ECpvX. The ECpvX can interface to the ECsync cabinet via Modbus RTU or Modbus TCP. The data read from the ECsync cabinet will be visualized on a dedicated page. Enable the Control if to use the dry contact outputs from the cabinet and send manual commands like mode change, breaker open/close etc. to the ECsync cabinet. The relay control is set up via EClogic whereas the various commands are set from the ECsync monitoring page.

ECpvX supports Modbus function code 0x06 and 0x10 for applying control commands. Some sync relays support only one of the two. Consult the Modbus Master documentation on ENcombi website to learn which function code to use with your ECsync cabinet:

<http://www.encombi.com/products/ecpvx/>

If data acquisition is enabled, the data read from the ECsync cabinet, will be visualized on dedicated pages under monitoring.

## RTU

On the same submenu level the page for setting up Modbus RTU specifics for ECsync cabinet communication is found. Clicking the up/down arrows will lead to it.

## RTU

Control type: UNICAST

Control ID: 30



ECsync interface via Modbus RTU setup page.  
Here the Modbus ID of the ECsync cabinet is set.

2023-10-02-11:09:08

The ECpvX can apply references as Unicast or as Broadcast. The Control ID is used for Unicast.

## TCP

On the same submenu level the page for setting up Modbus TCP specifics for ECsync cabinet communication is found. Clicking the up/down arrows will lead to it.

## TCP

Control IP: 192.168.1.100



ECsync interface via Modbus TCP setup page.  
Here the IP address of the ECsync cabinet is set.  
The RTU Control ID is used for the TCP frames.

2023-10-02-11:09:59

The RTU Control ID is used for the TCP frames.

## Logs

The ECpvX offers logging both locally on SD-card or USB-stick and as time series data pushed to an online database.

## Local logs with transmission via ftp

The ECpvX features logging stored locally on SD-card or on USB stick.  
The ECpvX can make three different logs:

- Event log
- Summary log
- Production log

The logs are stored locally on ECpvX; either on SD-card or on USB-stick.

A new Event log is generated every day. The event log holds entries of any events taking place or any occurrences of alarms on that particular day. All entries are time stamped. The ECpvX will in the text include the six most recent entries in the log.

A summary log is generated at midnight when the result of the past day is known. The log holds information about PV energy produced, revenue generated etc. The ECpvX can be set up to transfer the summary logs to an FTP server automatically. The transmission will occur at midnight when a summary log is generated.

A production log is generated at midnight when a new day has started. The following midnight when the day has passed the log is completed. The log holds a time-series of PV production, Mains power etc. The time interval is per default 5min. The ECpvX can be set up to push the production logs to an FTP server automatically. The transmission will occur at midnight when a production log is completed. The data in the production log is tabulator-separated and can be imported and plotted easily in excel.

All three logs can be displayed directly on ECweb. Below is an example of the production log and how it looks on ECweb. First page is a list of all the production logs available. Second page shows data from one of those logs:

2020-05-11	2020-06-06	2020-06-19
2020-05-12	2020-06-07	2020-06-20
2020-05-13	2020-06-08	2020-06-21
2020-05-14	2020-06-09	2020-06-23
2020-05-15	2020-06-10	2020-06-24
2020-05-16	2020-06-11	2020-06-25
2020-05-17	2020-06-12	2020-07-02
2020-05-18	2020-06-13	2020-07-03
2020-05-20	2020-06-14	2020-07-06
2020-05-22	2020-06-15	2020-07-07
2020-06-03	2020-06-16	2020-07-08
2020-06-04	2020-06-17	2020-07-09
2020-06-05	2020-06-18	2020-07-10

2020-07-10-13:54:17

Production log:

Time	PV[kW]	Genset[kW]	Mains[kW]	Load[kW]	PVcap.[kW]	PVref.[kW]	Genset[%]	POA[W/m2]	BOM[C]	Curtail Act	Start Act	GB On	MB On
00:00:51	0.0	0.0	0.0	0.0	100.0	0.0	0.0	1000.0	25.0	0	0	0	0
00:06:01	0.0	0.0	0.0	0.0	100.0	0.0	0.0	1000.0	25.0	0	0	0	0
00:11:04	0.0	0.0	0.0	0.0	100.0	0.0	0.0	1000.0	25.0	0	0	0	0
00:16:07	0.0	0.0	0.0	0.0	100.0	0.0	0.0	1000.0	25.0	0	0	0	0
00:21:09	0.0	0.0	0.0	0.0	100.0	0.0	0.0	1000.0	25.0	0	0	0	0
00:26:12	0.0	0.0	0.0	0.0	100.0	0.0	0.0	1000.0	25.0	0	0	0	0
00:31:14	0.0	0.0	0.0	0.0	100.0	0.0	0.0	1000.0	25.0	0	0	0	0
00:36:17	0.0	0.0	0.0	0.0	100.0	0.0	0.0	1000.0	25.0	0	0	0	0
00:41:20	0.0	0.0	0.0	0.0	100.0	0.0	0.0	1000.0	25.0	0	0	0	0
00:46:25	0.0	0.0	0.0	0.0	100.0	0.0	0.0	1000.0	25.0	0	0	0	0
00:51:30	80.0	0.0	20.0	100.0	100.0	80.0	0.0	1000.0	25.0	1	1	0	1
00:56:33	80.0	0.0	20.0	100.0	100.0	80.0	0.0	1000.0	25.0	1	1	0	1
01:01:36	80.0	0.0	20.0	100.0	100.0	80.0	0.0	1000.0	25.0	1	1	0	1
01:06:39	80.0	0.0	20.0	100.0	100.0	80.0	0.0	1000.0	25.0	1	1	0	1
01:11:41	80.0	0.0	20.0	100.0	100.0	80.0	0.0	1000.0	25.0	1	1	0	1

2020-07-10-13:55:25

Note that the column heading of the production log shown is not actually included in the actual file being transferred by FTP. The files only contain the data itself.

In a similar way, the Summary logs and Eventlog can be displayed.

Consult the "Control" chapter in this document for details on how to set up the various automatic file transmissions.

## Log to MySQL database

The ECpvX can push time series data to a MySQL database as well. This can be to an installer/customers own hosted database or it can be to an ENcombi hosted database.



### Log config

Host: mysqlhost.com

Database: mysql\_database

Username: mysql\_username

Password: \*\*\*\*\*

Table name: mysql\_tablename

Log rate: 5 min

Log: ENABLED

Cloud service: ENABLED



**MySQL setup page.**

When enabled, the device creates a table in the selected MySQL database should it not already be present. Afterwards the device pushes data to the table at the interval selected.

Tailor the data elements the device pushes and use your own MySQL database and preferred visualization tool. Alternatively use the Cloud service provided with the C-extra. In this case the table name and above settings are disregarded. Also the data elements pushed are fixed and can't be tailored.

In case connection to the MySQL database is lost, the device buffers data to local file and will be transferred once connection is re-established. local buffer file as well as the table in the database itself can be deleted from designated buttons.

Your device can come with free cloud service in a trial period. Below you can see if you have any free trial days available. Find the cloud service provider on the Identifiers page.

Buffer size:	<input type="text" value="0.0 kB"/>	
Table size:	<input type="text" value="27090"/>	
Free trial:	<input type="text" value="90 days"/>	

2020-07-10-13:55:57

When using an installer/customer hosted database the data visualization part is in the scope of the installer/customer as well. The data to push is configurable according to the MySQL documentation on ENcombi website:

<http://www.encombi.com/products/ecpvx/>

The option of using the ENcombi database requires the dedicated SW-extra "C" or time left of any complimentary free "C" trial period. The data pushed to the ENcombi database is fixed from ENcombi side and can't be tailored by installer/customer. The front-end for data visualization provided by ENcombi is called ECcloud. After the ECpvX has started pushing data to the ENcombi database the customer/installer can register it in ECcloud where data will be visualized immediately.

[www.encombi.online](http://www.encombi.online)



Welcome to ECcloud

Please enter your credentials

Enter username	<input type="text"/>
Enter password	<input type="password"/>
<input type="button" value="LOGIN"/>	

## EClogic

EClogic provides the possibility of making project specific logical expressions when required. That could be for linking physical digital inputs applied on power meters to the

position of circuit breakers or similar. Also here, RRCR can be set up providing the option of a superior control system to give power references for the ECpv to follow. First page presented when clicking the EClogic tile is the page below.

EClogic main page.

EClogic is a collection of logical features to use for site customization.

The Builder offers the possibility of logically combining various input states.  
This is done via graphical representation of logical gates.  
Say multiple breakers/contactors need to be in certain position before the PV plant is connected to Grid, this can be tailored in the Builder.  
The input to the gates are Modbus addresses and bitmasks.  
It will typically be addresses holding digital input statuses from various power meters.  
Consult the Modbus Slave documentation to identify the addresses of the inputs to use.  
Note that the default input address "0" is interpreted as "not used".  
The output of the gates are status set on dedicated Modbus addresses.  
Consult the Modbus Slave documentation to identify the addresses of the outputs generated.  
These statuses can then be used in the Linker to generate a command to the device.

The Linker offers the possibility of linking input states to commands.  
The input states are Modbus addresses and bitmasks.  
It will typically be addresses holding digital input statuses from various power meters or it can be addresses holding output status generated through the Builder.  
Consult the Modbus Slave documentation to identify the addresses of the inputs to use.  
Note that the default input address "0" is interpreted as "not used".  
The commands available are predefined commands on dedicated Modbus addresses.  
Consult the Modbus Slave documentation to identify the addresses of the available commands.

The RRCR is a dedicated configuration setup of RRCR functionality.  
16 unique Power reference levels based on 4 input combinations can be configured.

ADMIN

2022-09-30-09:43:27

EClogic is divided into five sub categories.

1. Builder
2. Linker
3. RRCR
4. Sensor
5. IO
6. Command timers
7. Command panel
8. Alarms

## Builder

The Builder offers the possibility of logically combining various input states. This is done via graphical representation of logical gates. Say multiple breakers/contactors need to be in a certain position before the PV plant is connected to the Grid, this can be tailored in the Builder.

The input to the gates are function code 0x04 Modbus addresses and bitmasks. It will typically be addresses holding digital input statuses from various power meters. Consult the Modbus Slave documentation to identify the addresses of the inputs to use. Note that the default input address "0" is interpreted as "not used".

The output/status of the gates are set on dedicated Modbus addresses. Consult the Modbus Slave documentation to identify the addresses of the outputs generated. These statuses can then be used in the Linker to generate a command to the device.

First page presented when clicking the builder button is the page below. Here an overview of the 16 builder lines supported is presented.

Each builder line consists of four gates. The status of the gates are represented by the color. Red means that the gate is false and green that the gate is true.

Clicking the line number will lead to the set up page for the specific line.

Each of the first three gates take four AND inputs and four AND NOT inputs. These three inputs are OR'ed together to generate one input to the output gate.

### Example

In the configuration shown above, address 3397 bit0 is used as input to Gate1. From Modbus Slave documentation this is found to be input1 on PV meter1. As the input1 is active the Gate1 state is true which again results in the output gate to be true. This will generate the following statuses in the designated modbus area to go high.

ECLOGIC BUILDER AREA 1				
28000	Q1 gate output status line 1-16	16 unsigned int	bitwise	Not defined
28001	Q2 gate output status line 1-16	16 unsigned int	bitwise	Not defined
28002	Q3 gate output status line 1-16	16 unsigned int	bitwise	Not defined
28003	Q-out gate output status line 1-16	16 unsigned int	bitwise	Not defined
28004	Inverted Q-out gate output status line	16 unsigned int	bitwise	Not defined
28005...28999	RESERVED	Not defined	Reserved for later use	Not defined

Address 28000 bit0: Gate1, line1  
 Address 28003 bit0: Output Gate, line1

## Linker

The Linker offers the possibility of linking input states to commands. The input states are Modbus addresses and bitmasks. It will typically be addresses holding digital input statuses from various power meters or it can be addresses holding output status generated through the Builder. Consult the Modbus Slave documentation to identify the addresses of the inputs to use. Note that the default input address "0" is interpreted as "not used".

The commands available are predefined commands on dedicated Modbus addresses. Consult the Modbus Slave documentation to identify the addresses of the available commands.

First page presented when clicking the linker button is the page below. Here the 32 linker lines supported can be set up. Furthermore, the status of each link is indicated by green and red color.

ENcombi
ADMIN

INPUTS				OUTPUTS				INPUTS				OUTPUTS			
Line:	Address:	Bit:	Status	Address:	Bit:	Status	Line:	Address:	Bit:	Status	Address:	Bit:	Status		
Line:1	28003	0	■	29019	0	■	Line:17	0	0	■	29000	0	■		
Line:2	28003	0	■	29053	7	■	Line:18	0	0	■	29000	0	■		
Line:3	28003	0	■	29055	2	■	Line:19	0	0	■	29000	0	■		
Line:4	0	0	■	29000	0	■	Line:20	0	0	■	29000	0	■		
Line:5	0	0	■	29000	0	■	Line:21	0	0	■	29000	0	■		
Line:6	0	0	■	29000	0	■	Line:22	0	0	■	29000	0	■		
Line:7	0	0	■	29000	0	■	Line:23	0	0	■	29000	0	■		
Line:8	0	0	■	29000	0	■	Line:24	0	0	■	29000	0	■		
Line:9	0	0	■	29000	0	■	Line:25	0	0	■	29000	0	■		
Line:10	0	0	■	29000	0	■	Line:26	0	0	■	29000	0	■		
Line:11	0	0	■	29000	0	■	Line:27	0	0	■	29000	0	■		
Line:12	0	0	■	29000	0	■	Line:28	0	0	■	29000	0	■		
Line:13	0	0	■	29000	0	■	Line:29	0	0	■	29000	0	■		
Line:14	0	0	■	29000	0	■	Line:30	0	0	■	29000	0	■		
Line:15	0	0	■	29000	0	■	Line:31	0	0	■	29000	0	■		
Line:16	0	0	■	29000	0	■	Line:32	0	0	■	29000	0	■		

2020-07-10-14:01:41

## Example continued

In the configuration shown above address 28003 bit0 being the status of the output gate of builder line1 is used to set commands on address 29019 bit0, 29053 bit7 and 29055 bit2 respectively. From Modbus Slave documentation this is found to be the commands for:

1. Relay 1-16 on all PV meters.
2. Minimum genset load 1-8.
3. RRCR input 1-4.

Hence activating input1 on PV meter1 has the effect of:

1. Activating relay1 on all PV meters present.
2. Overruling the parameter set under "Settings", using the Minimum genset load setting8 from EClogic instead.
3. RRCR input3 applied.

Point 2 and 3 will be explained in the following.

### OVERRULING OF SETTINGS PARAMETERS

On the same submenu level, a set up page for overruling certain key settings is found. Clicking the up/down arrows will lead it.

ENcombi

ADMIN

Address:	Bit:	Min. genset load:	Address:	Bit:	Genset 1:
29053	0	20.0 %	29054	0	100.0 kW
29053	1	30.0 %	29054	1	100.0 kW
29053	2	30.0 %	29054	2	100.0 kW
29053	3	30.0 %	29054	3	100.0 kW
29053	4	30.0 %	29054	4	100.0 kW
29053	5	30.0 %	29054	5	100.0 kW
29053	6	30.0 %	29054	6	100.0 kW
29053	7	35.0 %	29054	7	100.0 kW

2020-07-10-14:02:26

It is currently possible to overrule:

1. Minimum genset load.
2. Genset1 rating.
3. PV P reference.
4. Battery P reference.

From the example above it can be seen that ECpvX is now using a Minimum genset load of 35% regardless of whatever value is selected under Settings. In case the input1 on PV meter1 is removed the ECpvX will again follow the value selected under Settings. This can be useful in case gensets have different Minimum genset operating levels or if it is allowed in certain periods to operate genset(s) at a lower level.

Manipulation of the Genset1 rated power is intended for use when only one genset exists from the ECpvX point of view (one genset meter) but in fact multiple (up to 8) are present. Depending on which genset(s) are connected to the busbar, the rated power is summarized accordingly by the ECpvX. This way the rated power of genset1 is dynamically adjusted by the ECpvX to match the actual combination of gensets(s) connected.

ENcombi

ADMIN

Address:	Bit:	<input type="checkbox"/>	PV Ref. Overwrite	Address:	Bit:	<input type="checkbox"/>	Bat. Ref. Overwrite
29076	0	<input checked="" type="checkbox"/>	20.0 kW	29077	0	<input type="checkbox"/>	20.0 kW
29076	1	<input checked="" type="checkbox"/>	20.0 kW	29077	1	<input checked="" type="checkbox"/>	20.0 kW
29076	2	<input checked="" type="checkbox"/>	20.0 kW	29077	2	<input checked="" type="checkbox"/>	20.0 kW
29076	3	<input checked="" type="checkbox"/>	20.0 kW	29077	3	<input checked="" type="checkbox"/>	20.0 kW
29076	4	<input checked="" type="checkbox"/>	20.0 kW	29077	4	<input checked="" type="checkbox"/>	20.0 kW
29076	5	<input checked="" type="checkbox"/>	20.0 kW	29077	5	<input checked="" type="checkbox"/>	20.0 kW
29076	6	<input checked="" type="checkbox"/>	20.0 kW	29077	6	<input checked="" type="checkbox"/>	20.0 kW
29076	7	<input checked="" type="checkbox"/>	20.0 kW	29077	7	<input checked="" type="checkbox"/>	20.0 kW

2024-04-10-08:40:18

The set points for both PV and the Battery can be adjusted in the same manner.

## General Purpose Hysteresis

General purpose hysteresis is a generic configuration tool to trigger alarms based on different inputs.

General purpose hysteresis enables you to trigger a status in modbus based on thresholds limits of various measurements. Via the EClogic Builder/Linker the status triggered can be used to activate relates, set an ECloig general purpose alarm etc. A total of 8 such hysteresis are available.

ENcombi

ADMIN

Address:	Data type:	Data sign:	Low Threshold:	High Threshold:	Low Timer:	High Timer:	Output:	Set:	Reset:	Invert:
0	16BIT	SIGNED	0.0	0.0	0.0 s	0.0 s	<input checked="" type="checkbox"/>	<input type="checkbox"/>	<input type="checkbox"/>	<input checked="" type="checkbox"/>
0	16BIT	SIGNED	0.0	0.0	0.0 s	0.0 s	<input checked="" type="checkbox"/>	<input type="checkbox"/>	<input type="checkbox"/>	<input checked="" type="checkbox"/>
0	16BIT	SIGNED	0.0	0.0	0.0 s	0.0 s	<input checked="" type="checkbox"/>	<input type="checkbox"/>	<input type="checkbox"/>	<input checked="" type="checkbox"/>
0	16BIT	SIGNED	0.0	0.0	0.0 s	0.0 s	<input checked="" type="checkbox"/>	<input type="checkbox"/>	<input type="checkbox"/>	<input checked="" type="checkbox"/>
0	16BIT	SIGNED	0.0	0.0	0.0 s	0.0 s	<input checked="" type="checkbox"/>	<input type="checkbox"/>	<input type="checkbox"/>	<input checked="" type="checkbox"/>
0	16BIT	SIGNED	0.0	0.0	0.0 s	0.0 s	<input checked="" type="checkbox"/>	<input type="checkbox"/>	<input type="checkbox"/>	<input checked="" type="checkbox"/>
0	16BIT	SIGNED	0.0	0.0	0.0 s	0.0 s	<input checked="" type="checkbox"/>	<input type="checkbox"/>	<input type="checkbox"/>	<input checked="" type="checkbox"/>
0	16BIT	SIGNED	0.0	0.0	0.0 s	0.0 s	<input checked="" type="checkbox"/>	<input type="checkbox"/>	<input type="checkbox"/>	<input checked="" type="checkbox"/>

2021-09-21-10:45:13

The address column is the input for the hysteresis. The data type and sign for the selected address must be changed according to the modbus manual for the address. The hysteresis is built up with a low threshold and a high threshold.

If the value from the address is lower than the low threshold value, the low timer will start. After the lower timer has expired, the output box will change color to green which indicates that the line is present. The status of each line can also be read out on modbus.

If the value from the address is higher than the high threshold value, the high timer will start. After the high timer expires, the output box will change color to red which indicates that the line is not present any more.

It is possible to manually force the line to be set or reset by clicking on the buttons corresponding to the line which should be forced.

Furthermore it is possible to inverse the output by clicking the button.

The hysteresis output status can be used in the ELogic Builder/Linker using the addresses below.

31014	BITFIELD_15	16 unsigned int	ELogic Threshold output 01..16
-------	-------------	-----------------	--------------------------------

## RRCR

The RRCR is a dedicated configuration setup of RRCR functionality.

16 unique power and cosphi reference levels based on 4 input combinations can be configured.

ENcombi ADMIN

	4	3	2	1	Power limit:	Enable:		4	3	2	1	Power limit:	Enable:
	■	■	■	■	100.0 %	DISABLED		■	■	■	■	100.0 %	DISABLED
	■	■	■	■	100.0 %	DISABLED		■	■	■	■	100.0 %	DISABLED
	■	■	■	■	100.0 %	DISABLED		■	■	■	■	100.0 %	DISABLED
	■	■	■	■	100.0 %	DISABLED		■	■	■	■	100.0 %	DISABLED
<input checked="" type="checkbox"/>	■	■	■	■	40.0 %	ENABLED		■	■	■	■	100.0 %	DISABLED
	■	■	■	■	100.0 %	DISABLED		■	■	■	■	100.0 %	DISABLED
	■	■	■	■	100.0 %	DISABLED		■	■	■	■	100.0 %	DISABLED
	■	■	■	■	100.0 %	DISABLED		■	■	■	■	100.0 %	DISABLED

2020-07-10-14:03:41

4	3	2	1	Cosphi ref:	Enable:	4	3	2	1	Cosphi ref:	Enable:
■	■	■	■	1.000	DISABLED	■	■	■	■	1.000	DISABLED
■	■	■	■	1.000	DISABLED	■	■	■	■	1.000	DISABLED
■	■	■	■	1.000	DISABLED	■	■	■	■	1.000	DISABLED
■	■	■	■	1.000	DISABLED	■	■	■	■	1.000	DISABLED
✓	■	■	■	1.000	DISABLED	■	■	■	■	1.000	DISABLED
■	■	■	■	1.000	DISABLED	■	■	■	■	1.000	DISABLED
■	■	■	■	1.000	DISABLED	■	■	■	■	1.000	DISABLED
■	■	■	■	1.000	DISABLED	■	■	■	■	1.000	DISABLED



2020-07-10-14:04:42

Referring to the ongoing example, as input1 on PV meter1 is active, it means that the RRCR input combination with only input3 being present is true. This is indicated by a check mark. As this line at the same time is enabled, it causes the ECpvX to overrule whatever power reference calculated based on setup made under "Settings" and the current plant status and target the reference dictated by the RRCR instead. A limit option is available for the power as well. When set to limit, the power output of the PV plant is limited to the chosen percentage instead of being overruled.



## AIO

Toggle in the RRCR configuration will lead you to the following page.

[ENcombi](#)

ADMIN

Address:	Bit:	Address:	Data type:	Data sign:	Input reference	  
29065	0	0	16BIT	SIGNED	PREF	<input checked="" type="checkbox"/>
29065	1	0	16BIT	SIGNED	QREF	<input checked="" type="checkbox"/>

2022-02-01-09:46:25

It is possible to set up an input for the reference of P and Q.

If the address 29065, bit 0 and 1, is set, then the ECpvX will use the reference read from the address which is typed in. This could be AIO input.



The reference is a percentage of the rated capacity of the inverter.

## Sensor

By clicking on the sensor icon, it will lead to the following page.

[ENcombi](#)

ADMIN

Address:	Data type:	Data sign:	  
0	16BIT	SIGNED	→ POA <input checked="" type="checkbox"/>
0	16BIT	SIGNED	→ BOM <input checked="" type="checkbox"/>
0	16BIT	SIGNED	→ GHI <input checked="" type="checkbox"/>
0	16BIT	SIGNED	→ Ambient Temp <input checked="" type="checkbox"/>
0	16BIT	SIGNED	→ Wind speed <input checked="" type="checkbox"/>
0	16BIT	SIGNED	→ RH <input checked="" type="checkbox"/>
0	16BIT	SIGNED	→ BAR pressure <input checked="" type="checkbox"/>
0	16BIT	SIGNED	→ Wind dir <input checked="" type="checkbox"/>
0	16BIT	SIGNED	→ Rain <input checked="" type="checkbox"/>

2022-03-14-12:03:13

Address:	Data type:	Data sign:	Scale:		
0	16BIT	SIGNED	1.0	→	Fuel Level 01 <span style="color:red">■</span>
0	16BIT	SIGNED	1.0	→	Fuel Level 02 <span style="color:red">■</span>
0	16BIT	SIGNED	1.0	→	Fuel Level 03 <span style="color:red">■</span>
0	16BIT	SIGNED	1.0	→	Fuel Level 04 <span style="color:red">■</span>
0	16BIT	SIGNED	1.0	→	Fuel Pressure 01 <span style="color:red">■</span>
0	16BIT	SIGNED	1.0	→	Fuel Pressure 02 <span style="color:red">■</span>
0	16BIT	SIGNED	1.0	→	Fuel Pressure 03 <span style="color:red">■</span>
0	16BIT	SIGNED	1.0	→	Fuel Pressure 04 <span style="color:red">■</span>



2022-04-06-13:23:16

From here it is possible to define the address of the sensor data readings. After defining the address for the specific sensor data, it should be selected in the sensor setup to read the data from “EClogic”.

The red indicator will change to green when selecting “EClogic” on the setup page of sensors.

## IO

By clicking on the IO icon, it will lead to the following page.

Address:	Data type:	Data sign:	Module.Channel	Address:	Data type:	Data sign:	Module.Channel
0	16BIT	SIGNED	→ 1.1	0	16BIT	SIGNED	→ 3.1
0	16BIT	SIGNED	→ 1.2	0	16BIT	SIGNED	→ 3.2
0	16BIT	SIGNED	→ 1.3	0	16BIT	SIGNED	→ 3.3
0	16BIT	SIGNED	→ 1.4	0	16BIT	SIGNED	→ 3.4
0	16BIT	SIGNED	→ 2.1	0	16BIT	SIGNED	→ 4.1
0	16BIT	SIGNED	→ 2.2	0	16BIT	SIGNED	→ 4.2
0	16BIT	SIGNED	→ 2.3	0	16BIT	SIGNED	→ 4.3
0	16BIT	SIGNED	→ 2.4	0	16BIT	SIGNED	→ 4.4



2022-02-01-11:08:38

From here it is possible to set up which data should be linked to each output of the AIO module. All 16 outputs are present and it is possible to select which data to be sent out on each channel.

## Command timers

By clicking on the command timer icon, it will lead to the following page.

### Command timers 1

Start day: Mon-Sun  
 Start hour: 18 h  
 Start minute: 0 min  
 Stop hour: 6 h  
 Stop minute: 0 min



Command timer setup page.  
 Here the command timer period can be defined using the command time start and command time stop settings.  
 The output will be placed in modbus.



2023-02-06-23:22:58

It is possible to set up 4 command timers. Type in the start day and time and stop time for the command timer. The output will be available on modbus and can be used for EClodic status/commands.

### Charge scheduler

By clicking on the battery icon, it will lead to the following page where the battery charge/discharge scheduler can be configured.

### Charge scheduler

Power	Enable:	Power	Enable:	Power	Enable:
00.00..01.00	0.0 % CHARGE	08.00..09.00	0.0 % CHARGE	16.00..17.00	0.0 % DISABLED
01.00..02.00	0.0 % CHARGE	09.00..10.00	0.0 % CHARGE	17.00..18.00	0.0 % DISABLED
02.00..03.00	0.0 % CHARGE	10.00..11.00	0.0 % CHARGE	18.00..19.00	0.0 % DISABLED
03.00..04.00	0.0 % CHARGE	11.00..12.00	0.0 % CHARGE	19.00..20.00	0.0 % DISABLED
04.00..05.00	0.0 % CHARGE	12.00..13.00	100.0 % CHARGE	20.00..21.00	0.0 % DISABLED
05.00..06.00	0.0 % CHARGE	13.00..14.00	100.0 % DISCHARGE	21.00..22.00	0.0 % DISABLED
06.00..07.00	0.0 % CHARGE	14.00..15.00	0.0 % DISABLED	22.00..23.00	100.0 % CHARGE
07.00..08.00	0.0 % CHARGE	15.00..16.00	0.0 % DISABLED	23.00..00.00	100.0 % DISCHARGE

2023-02-07-01:41:52

Note that the scheduler is only functional when the battery is parallel to the grid. The scheduler control is enabled on an hourly basis by the dedicated setting. Scheduler control references will overrule the charge/discharge references originating from the normal mode operations and the associated settings in the Battery Charge and Dispatch menus. Still the transformer limits will overrule any scheduler control references that exceed them.

## Command panel

The command panel holds 16 configurable command buttons and 16 status indicators. By clicking on the command panel icon, it will lead to the following page where the associated text strings for the 16 buttons and indicators can be typed in.

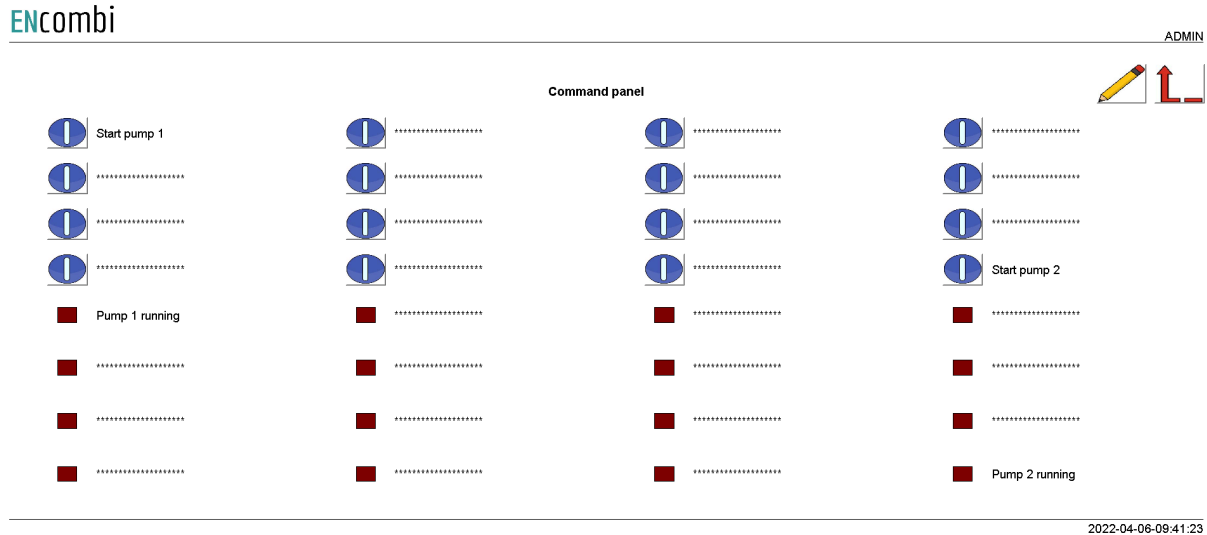

The actual functionality of the command panel is set up in the Builder/Linker using the addresses below.

31019	BITFIELD_19	16 unsigned int	Command Panel buttons 01..16
29066	Cmd panel LED01..16: Green	16 unsigned int	bitwise
29067	Cmd panel LED01..16: Red	16 unsigned int	bitwise

## General purpose alarms

General purpose alarms enable you to trigger your own custom made alarm. Via the ECLogic Builder/Linker the trigger for the alarm is set up. A total of 8 such alarms are available.

### ECLogic alarm 1

Delay: 5.0 s

Signal: DISABLED

Action: NOTIFICATION

Auto ack.: ENABLED

Alarm text: ECLogic AI01



ECLogic alarm setup page.  
 When the ECLogic alarm is triggered then the alarm condition is present.  
 The alarm is triggered from ECLogic.  
 When the condition has been present for a period equal to or longer than the delay, and in case the alarm is enabled, the alarm is provoked.  
 When the alarm is provoked, the signal selected will be activated and the action selected will be taken.  
 The alarm is automatically acknowledged in case auto ack. is enabled.

2022-09-30-09:47:33

The alarm trigger is set up in the ECLogic Builder/Linker using the addresses below.

29068	ECLogic Alarms 01..08	16 unsigned int	bitwise
-------	-----------------------	-----------------	---------

## General purpose timers

General purpose timers enable you to trigger your own custom made timer. Via the ECLogic Builder/Linker the trigger for the timer to be set up. A total of 8 such timers are available.

### ECLogic timers

Timer 1: 5.0 s

Timer 2: 5.0 s

Timer 3: 5.0 s

Timer 4: 5.0 s

Timer 5: 5.0 s

Timer 6: 5.0 s

Timer 7: 5.0 s

Timer 8: 5.0 s



ECLogic timer setup page.  
 The commands for starting the timers are set from ECLogic.  
 The timer elapsed status is available in modbus and can be used as in ECLogic.

2022-10-11-14:52:37

The timer triggers is set up in the ECLogic builder/Linker using the addresses below:

29069	ECLogic Timers 01..08	16 unsigned int	bitwise
-------	-----------------------	-----------------	---------

The output of the timers when they are elapsed are found on the addresses below:

31021	BITFIELD_22	16 unsigned int	ECLogic Timers elapsed 01..16
-------	-------------	-----------------	-------------------------------

## Monitoring

The ECweb provides a high level overview of the installation as well as detailed information about each individual inverter and power meter. Below is an example of the first page presented under the Monitoring tile.

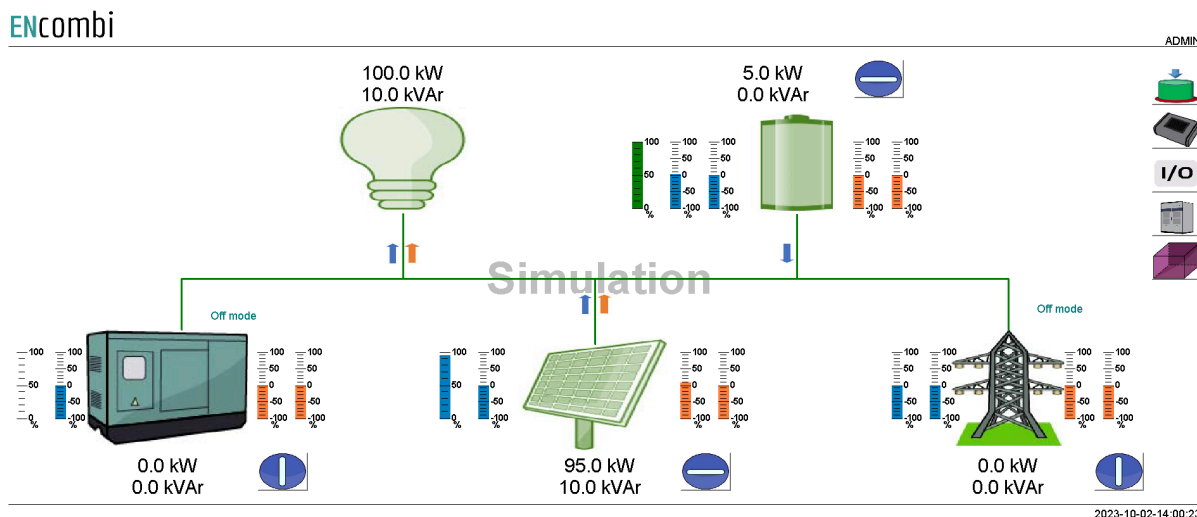

If the genset, PV, battery or utility symbol is grayed out, it means that no configuration for sensing of the associated power is made and therefore the source is interpreted as not being present by the ECpvX. The accumulated powers of the three sources as well as total consumptions are displayed.

In case the genset symbol is neither gray nor green it means that all genset breakers are off. In case the genset symbol is green it means that at least one genset breaker is on.

In case the utility symbol is neither gray nor green it means that all mains breakers are off. In case the utility symbol is green it means that at least one mains breaker is on.

In case the PV symbol is neither gray nor green it means that the start signal is not present. In case the PV symbol is green it means that the start signal is present.

In case the PV start button has a vertical line it means that the stop signal is present and the button can be clicked to start the PV plant. In case the PV button has a horizontal line it means that the start signal is present and the button can be clicked to stop the PV plant.

In case the battery symbol is neither gray nor green it means that the start signal is not present. In case the battery symbol is green it means that the start signal is present.

In case the battery start button has a vertical line it means that the stop signal is present and the button can be clicked to start the battery plant. In case the battery button has a

horizontal line it means that the start signal is present and the button can be clicked to stop the battery plant.

In case the genset start button has a vertical line it means that the stop signal is present and the button can be clicked to start the genset plant. In case the genset button has a horizontal line it means that the start signal is present and the button can be clicked to stop the genset plant. Note that this button is only visible in case Genset management functionality is enabled.

Blue and orange arrows indicate active power and reactive power flow direction respectively.

On the left hand side of the sources two blue bar graphs are shown. The one to the left shows the active power loading of the source in percentage. The one to the right shows the deviation from the active power reference in percentage.

On the right hand side of the sources two orange bar graphs are shown. The one to the left shows the reactive power loading of the source in percentage. The one to the right shows the deviation from the reactive power reference in percentage.

In the upper right corner four buttons are shown.

5. Command panel
6. Sensor data.
7. IO module data.
8. Simulation stimuli.

## Command panel

Clicking the command panel button will lead to the page below where the button commands and status indications are displayed.

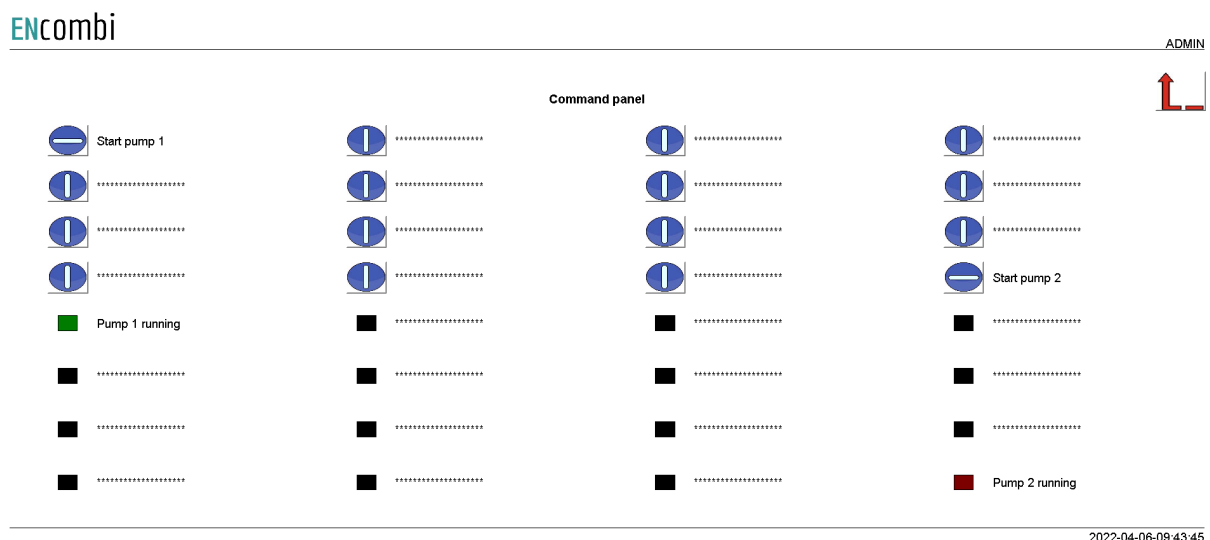

## Sensor data

Clicking the sensor button will lead to the below page where an overview of all the meteorological readings is provided. If a reading is not supported or communication to the sensor or inverter providing the reading is failing, the readings will be displayed as "N.A".

ENcombi ADMIN

Measurement

POA:	1000 W/m2	RH:	N.A	Fuel level 01:	45.6 %
GHI:	N.A	Bar. press.:	N.A	Fuel level 02:	N.A
BOM:	25.0 C	Wind speed:	N.A	Fuel level 03:	N.A
Amb. temp.:	N.A	Wind dir.:	N.A	Fuel level 04:	N.A
		Rain:	N.A		

2022-03-14-12:06:47

Clicking the up/down navigation buttons will lead to the page below which is displaying the fuel level data.

ENcombi ADMIN

Measurement

Fuel pressure 01:	N.A	Fuel level 01:	45.6 %
Fuel pressure 02:	N.A	Fuel level 02:	N.A
Fuel pressure 03:	N.A	Fuel level 03:	N.A
Fuel pressure 04:	N.A	Fuel level 04:	N.A

2022-04-06-10:41:21

Consult the Modbus master documentation on ENcombi website for detailed information about what data is read from the various sensor and inverter models: <http://www.encombi.com/products/ecpvx/>



## IO module data

Clicking the IO module button will lead to the below page where an overview of all the readings from the IO modules is provided. In case a reading is not supported or communication to the IO module is failing, the readings will be displayed as "N.A".

The screenshot shows the ENcombi interface for IO module data. At the top right, there is an 'ADMIN' link. The main content is a table with four columns: 'IO modules', 'IO type', 'IO inputs', and 'IO outputs'. There are also 'Communication state' and 'Communication enable' columns with associated icons. The table lists four IO modules (IO 1 to IO 4) with their respective types and readings. IO 1 and IO 2 show numerical readings, while IO 3 and IO 4 show 'N.A'. To the right of the table, there are several status icons, including a thumbs up, a thumbs down, and a red alarm icon.

IO modules	IO type	IO inputs	IO outputs	Communication state:	Communication enable:
IO 1:	EX1600DD	0000 0000 0000 1000	N.A		
IO 2:	EX1608DD	0000 0000 0001 0000	0000 0000 0000 0000		
IO 3:	OFF	N.A	N.A	N.A	N.A
IO 4:	OFF	N.A	N.A	N.A	N.A

2020-08-18-11:18:25

## ECsync data

Clicking the ECsync cabinet button will lead to the below page where an overview of all the readings from the ECsync cabinet is provided. In case a reading is not supported or communication to the ECsync cabinet is failing, the readings will be displayed as "N.A". Open and close commands can be applied as well as acknowledging alarms in the ECsync cabinet.

The screenshot shows the ENcombi interface for ECsync data. At the top right, there is an 'ADMIN' link. The main content is divided into several sections: 'Readings Grid', 'Readings Busbar', 'Powers', 'Angles', 'Commands', and 'Status'. Each section contains specific data points. The 'Readings Grid' and 'Readings Busbar' sections show voltages and angles for three phases (L1, L2, L3). The 'Powers' section shows ACP and ACO readings. The 'Angles' section shows L1, L2, and L3 angles. The 'Commands' section has 'OPEN' and 'Ack Alarm' buttons. The 'Status' section shows input readings and a list of alarm types with checkboxes. To the right of the status section, there are several status icons, including a thumbs up, a thumbs down, and a red alarm icon.

Version:	1172		
<b>Readings Grid</b>	<b>Readings Busbar</b>	<b>Powers</b>	<b>Angles</b>
<b>Voltages</b>	<b>Voltages</b>	ACP 1: 0 kW	L1 ANG: 0.0 Deg
L1L2: 400 V	L1L2: 400 V	ACP 2: 0 kW	L2 ANG: 0.0 Deg
L2L3: 400 V	L2L3: 400 V	ACP 3: 0 kW	L3 ANG: 0.0 Deg
L3L1: 400 V	L3L1: 400 V	ACP: 0 kW	
L1N: 231 V	L1N: 231 V	ACO 1: 0 kVAr	<b>Commands</b>
L2N: 231 V	L2N: 231 V	ACO 2: 0 kVAr	
L3N: 231 V	L3N: 231 V	ACO 3: 0 kVAr	
		ACO: 0 kVAr	<b>Status</b>
<b>Angles</b>	<b>Angles</b>	ACS 1: 0 kVA	Inputs: 0000 0000 0000 0100
L1L2 ANG: 120.0 Deg	L1L2 ANG: 120.0 Deg	ACS 2: 0 kVA	<input type="checkbox"/> Meas. alarm
L2L3 ANG: 120.0 Deg	L2L3 ANG: 120.0 Deg	ACS 3: 0 kVA	<input type="checkbox"/> Sync. alarm
L3L1 ANG: 120.0 Deg	L3L1 ANG: 120.0 Deg	ACS: 0 kVA	<input type="checkbox"/> Open alarm
			<input type="checkbox"/> Close alarm
<b>Frequencies</b>	<b>Frequencies</b>	<b>Currents</b>	<input type="checkbox"/> Position alarm
HZ 1: 50.0 Hz	HZ 1: 50.0 Hz	L1A: 0 A	<input type="checkbox"/> Phase seq. alarm
HZ 2: 50.0 Hz	HZ 2: 50.0 Hz	L2A: 0 A	<input type="checkbox"/> Trip alarm
HZ 3: 50.0 Hz	HZ 3: 50.0 Hz	L3A: 0 A	<input type="checkbox"/> Any unack. alarm
			<input type="checkbox"/> Not in Auto
			Communication state:
			Communication enable:

2023-10-02-11:33:12

## Simulation

In case simulation is enabled, it will be indicated as a watermark.

ENcombi

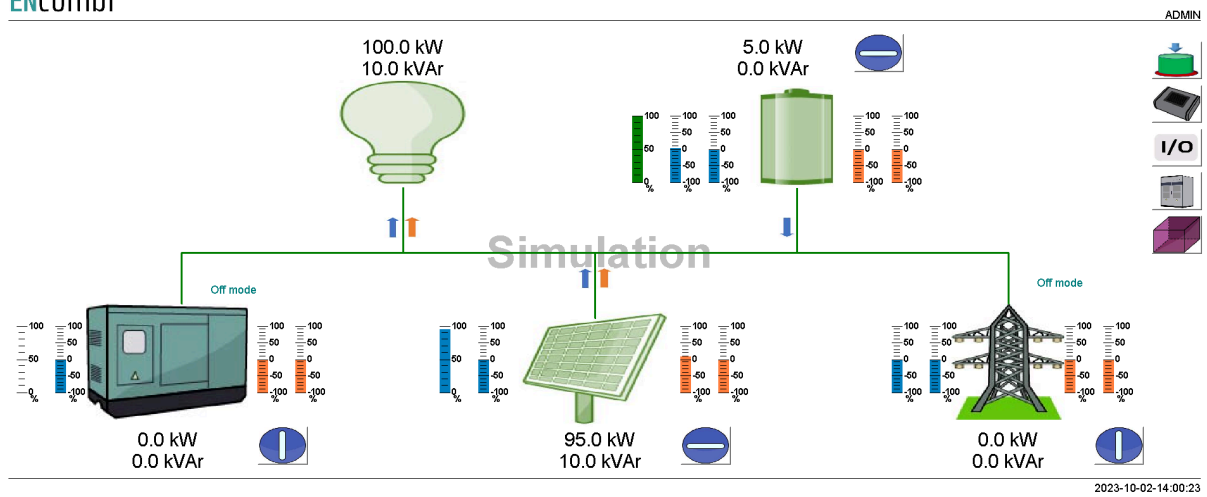

Furthermore an additional button appears in the upper right corner which. Clicking this button will open the Stimuli page below.

2020-07-10-14:11:29

On this page various stimuli can be applied. The changes made take effect when the window is closed. Closing the window will lead back to the monitoring page.

Clicking on the arrows will lead you to the next page where other various stimuli can be applied.

2021-09-20-14:14:01

## PV

Clicking the PV icon leads to the below pages where more detailed information of the PV plant can be found. Clicking the up/down arrows will browse through them.

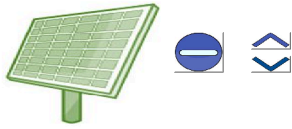

### Production

ACP: 20.0 kW  
 ACQ: 0.0 kVAr  
 ACS: 20.0 kVA  
 Cosphi: 1.000 C

### Produced

ACE: 1 kWh  
 ACE YEAR: 1 kWh  
 ACE MONTH: 1 kWh  
 ACE DAY: 1 kWh

### Curtailed

ACE: 0 kWh  
 ACE YEAR: 0 kWh  
 ACE MONTH: 0 kWh  
 ACE DAY: 0 kWh

### References

GC: 20.0 kW  
 PTAR: 20.0 kW  
 PREF: 20.0 kW  
 QTAR: 0.0 kVAr  
 QREF: 0.0 kVAr  
 CURTAILMENT: INACTIVE

### Penetration

PEN: 16.4 %  
 PEN YEAR: 16.4 %  
 PEN MONTH: 16.4 %  
 PEN DAY: 16.4 %

### Performance

PERF: 100.0 %  
 PERF YEAR: 100.0 %  
 PERF MONTH: 100.0 %  
 PERF DAY: 100.0 %

2021-09-20-14:14:31

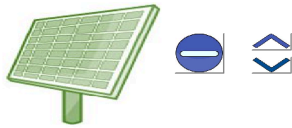

### Produced

ACE: 1 kWh  
 ACE YEAR: 1 kWh  
 ACE MONTH: 1 kWh  
 ACE DAY: 1 kWh

### Available

ACE: 2 kWh  
 ACE YEAR: 2 kWh  
 ACE MONTH: 2 kWh  
 ACE DAY: 2 kWh

### Curtailed

ACE: 0 kWh  
 ACE YEAR: 0 kWh  
 ACE MONTH: 0 kWh  
 ACE DAY: 0 kWh

### Penetration

PEN: 16.5 %  
 PEN YEAR: 16.5 %  
 PEN MONTH: 16.5 %  
 PEN DAY: 16.5 %

### Performance

PERF: 100.0 %  
 PERF YEAR: 100.0 %  
 PERF MONTH: 100.0 %  
 PERF DAY: 100.0 %

2021-09-20-14:14:44

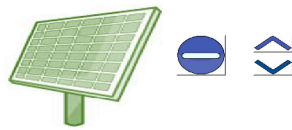

### PV export save

Total: 0 Euro  
 Year: 0 Euro  
 Month: 0 Euro  
 Day: 0 Euro

### Mains imp. save

Total: 0 Euro  
 Year: 0 Euro  
 Month: 0 Euro  
 Day: 0 Euro

2021-09-20-14:14:58

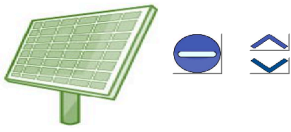

### Fuel save

Total: 82 liter  
Year: 82 liter  
Month: 82 liter  
Day: 1 liter

### Fuel exp. save

Total: 46 Euro  
Year: 46 Euro  
Month: 46 Euro  
Day: 1 Euro

### CO2 emiss. save

Total: 217 kg  
Year: 217 kg  
Month: 217 kg  
Day: 3 kg

On the right hand side of the above pages two buttons are presented that will lead to pages with more information about.

1. PV meter data.
2. Inverter data.

## PV meter data

Clicking the meter icon will lead to the below page where an overview of power and reactive power readings from all PV meters is provided. In the example below, only one PV meter is present. In case communication to a PV meter is failing, the readings will be displayed as "N.A".

ENcombi ADMIN

PV	P	Q	PV	P	Q
Meter 1	20.0 kW	0.0 kVAr			

2020-07-10-14:13:40

Clicking on a PV meter label, "Meter1" being the only option in the above example, will lead to a page with more detailed information about that specific PV meter.

ENcombi ADMIN

<b>Identifiers:</b>		<b>Power factors</b>		<b>Voltages</b>	
Meter 1		PF 1:	1.0	L1N:	230.9 V
Comm ID:	ID2	PF 2:	1.0	L2N:	230.9 V
		PF 3:	1.0	L3N:	230.9 V
<b>Powers</b>		PF:	1.0	L1L2:	400.0 V
ACP 1:	6.666 kW	<b>Currents</b>		L2L3:	400.0 V
ACP 2:	6.666 kW	L1A:	28.868 A	L3L1:	400.0 V
ACP 3:	6.666 kW	L2A:	28.868 A	<b>Frequencies</b>	
ACP:	20.0 kW	L3A:	28.868 A	HZ 1:	50.0 Hz
ACQ 1:	0.0 kVAr	LNA:	0.0 A	HZ 2:	50.0 Hz
ACQ 2:	0.0 kVAr	<b>Produced</b>		HZ 3:	50.0 Hz
ACQ 3:	0.0 kVAr	ACE:	N.A.	<b>Status</b>	
ACQ:	0.0 kVAr	ACE IMP:	N.A.	Inputs:	0000 0000 0000 0000
ACS 1:	6.666 kVA	ACE EXP:	N.A.		
ACS 2:	6.666 kVA	ACRE:	N.A.		
ACS 3:	6.666 kVA	ACRE IND:	N.A.		
ACS:	20.0 kVA	ACRE CAP:	N.A.		

Communication state:   
Communication enable:

2020-07-10-14:13:57

In the upper left corner the label of the meter can be changed. In the lower right corner communication status for the specific PV meter is shown. In case the PV meter is failing

to communicate for whatever reason, communication to that specific meter can be disabled and enabled again at a later stage on the start/stop button. Not all data shown is read/displayed from all meter models supported and will in that case show "N.A.". Consult the Modbus master documentation on the ENcombi website for detailed information about what data is read from the various meter models.

<http://www.encombi.com/products/ecpvx/>





## Inverter data

Clicking the inverter icon will lead to the below page where an overview of power and reactive power readings from all inverters is provided. In case communication to an inverter is failing, the readings will be displayed as "N.A".

ENcombi						ADMIN
Inverter	P	Q	Inverter	P	Q	
Inverter 1	5.0 kW	0.0 kVAr				
Inverter 2	5.0 kW	0.0 kVAr				
Inverter 3	5.0 kW	0.0 kVAr				
Inverter 4	5.0 kW	0.0 kVAr				

2020-07-10-14:14:31

Clicking on an inverter label will lead to a page with more detailed information about that specific inverter.

ENcombi						ADMIN
<b>Identifiers:</b>		<b>AC</b>		<b>DC</b>		
Inverter 2	246413	L1N:	230.9 V	DCA1:	1.6 A	
Serial:	Virtual	L2N:	230.9 V	DCU1:	713.1 V	
Model:	1.00.0	L3N:	230.9 V	DCP1:	1.2 kW	
Version:	ID2	L1L2:	400.0 V	DCA2:	1.6 A	
Comm ID:		L2L3:	400.0 V	DCU2:	713.1 V	
		L3L1:	400.0 V	DCP2:	1.2 kW	
<b>Production</b>		L1A:	7.2 A	DCA3:	1.6 A	
ACP:	5.0 kW	L2A:	7.2 A	DCU3:	713.1 V	
ACQ:	0.0 kVAr	L3A:	7.2 A	DCP3:	1.2 kW	
ACS:	5.0 kVA	HZ:	50.0 Hz	DCA4:	1.6 A	
PF:	1.0			DCU4:	713.1 V	
				DCP4:	1.2 kW	
<b>Produced</b>		<b>Status</b>				
ACE:	N.A.	CAB TEMP:	49.8 C			
ACE DAY:	N.A.	STATE:	N.A.			
OPE:	N.A.	EVT1:	N.A.			
OPE DAY:	N.A.	EVT2:	N.A.			
		EVT3:	N.A.			
		EVT4:	N.A.			
				Communication state:		
				Communication enable:		

2020-07-10-14:15:07

In the upper left corner the label of the inverter can be changed. In the lower right corner communication status for the specific inverter is shown. In case the inverter is

failing to communicate for whatever reason, communication to that specific inverter can be disabled and enabled again at a later stage on the start/stop button.

Not all data shown is read/displayed from all inverter models supported and will in that case show "N.A". Consult the Modbus master documentation on the ENcombi website for detailed information about what data is read from the various inverter models.

<http://www.encombi.com/products/ecpvx/>



## Genset

Clicking the genset icon leads to the below page where more detailed information of the genset plant can be found.



**Production**

ACP: 30.0 kW  
 ACQ: 10.0 kVAr  
 ACS: 31.6 kVA  
 Cosphi: 0.948 C

**LOADING:**

GC: 100.0 kW  
 LOADING: 30.0 %  
 PTAR: 30.0 %

**Fuel consumed**

Total: 2262 liter  
 Year: 2262 liter  
 Month: 2262 liter  
 Day: 1 liter

**Fuel expense**

Total: 2784 Euro  
 Year: 2784 Euro  
 Month: 2784 Euro  
 Day: 1 Euro

**Produced**

ACE: 8844 kWh  
 ACE YEAR: 8844 kWh  
 ACE MONTH: 8844 kWh  
 ACE DAY: 2 kWh

**CO2 emission**

Total: 5973 kg  
 Year: 5973 kg  
 Month: 5973 kg  
 Day: 1 kg

On the right hand side of the above pages a button is presented that will lead to pages with more information about genset meters.

## Genset meter data

Clicking the meter icon will lead to similar pages holding genset meter data as already documented previously for PV meters. Refer to that chapter for more information.

## Mains

Clicking the utility icon leads to the below page where more detailed information about the utility can be found.

**Production**

ACP:	0.0 kW
ACQ:	0.0 kVAr
ACS:	0.0 kVA
Cosphi:	1.000 C

**Imported**

ACE:	0 kWh
ACE YEAR:	0 kWh
ACE MONTH:	0 kWh
ACE DAY:	0 kWh
Total:	0 Euro
Year:	0 Euro
Month:	0 Euro
Day:	0 Euro

**Exported**

ACE:	0 kWh
ACE YEAR:	0 kWh
ACE MONTH:	0 kWh
ACE DAY:	0 kWh
Total:	0 Euro
Year:	0 Euro
Month:	0 Euro
Day:	0 Euro

2023-09-18-08:31:44

On the right hand side of the above pages a button is presented that will lead to pages with more information about mains meters.

If the spot price market tariffs is enabled and the ECpvX has successfully pulled the spot prices, and additional button below the meter button will appear

### Mains meter data

Clicking the meter button will lead to similar pages holding mains meter data as already documented previously for PV meters. Refer to that chapter for more information.

### Spot price market data

Clicking the spot price button will lead to the page below where the hourly spot prices can be seen.

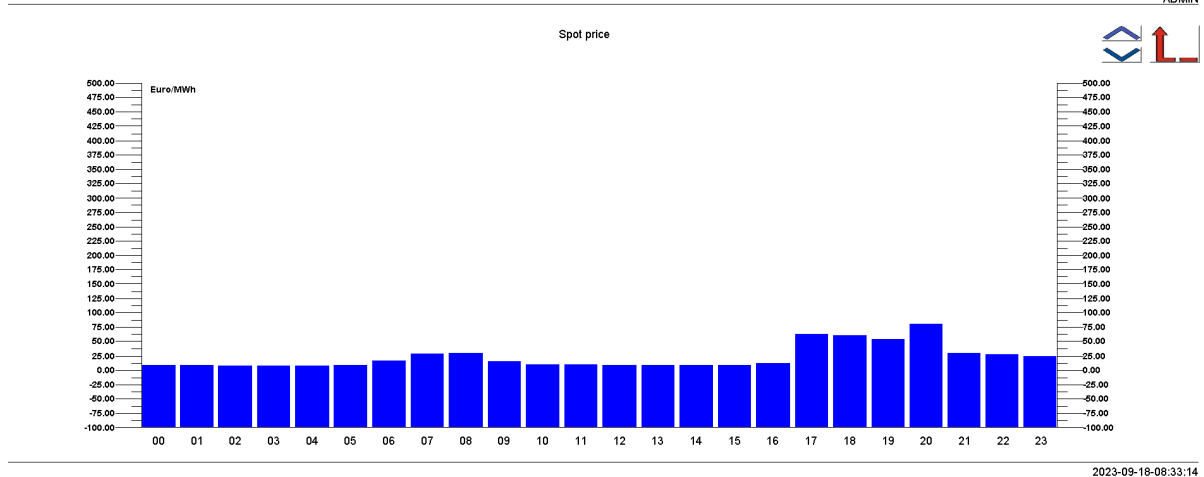

If the ECpvX is set up to do arbitrage control based on the spot prices, two navigation buttons for scrolling up/down will appear. Clicking these will take you through the pages below where various forecasts of the day's performance and profit are shown.

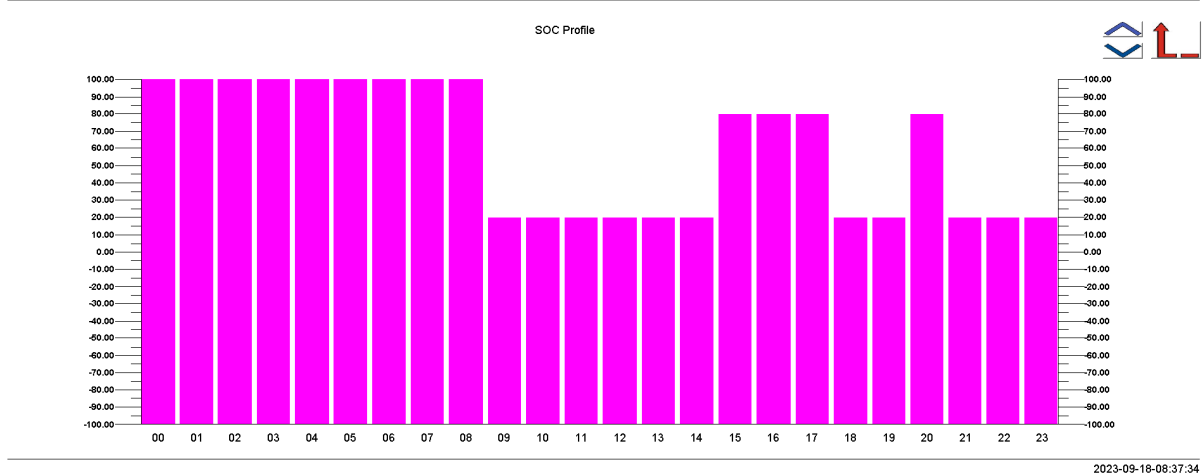
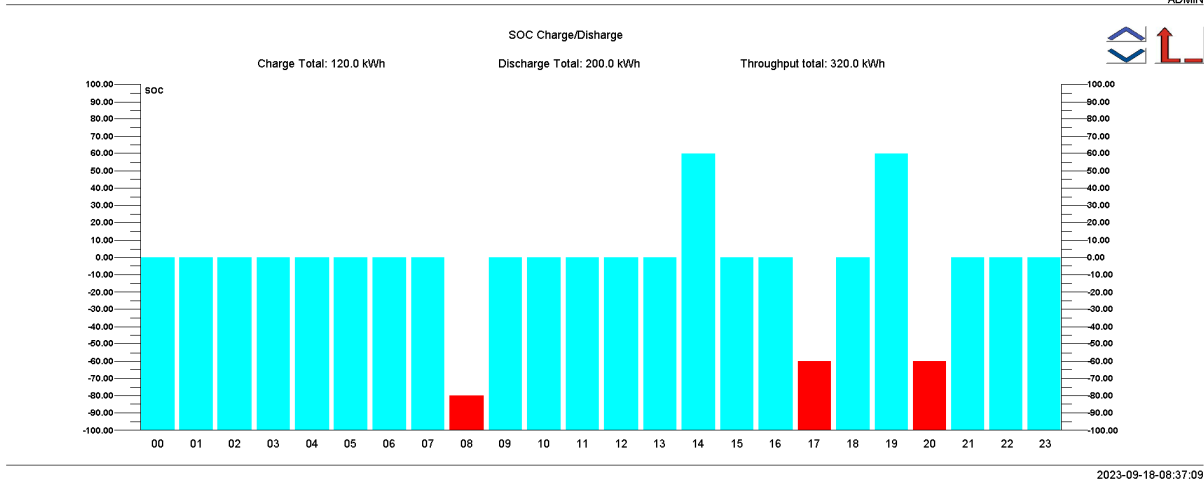

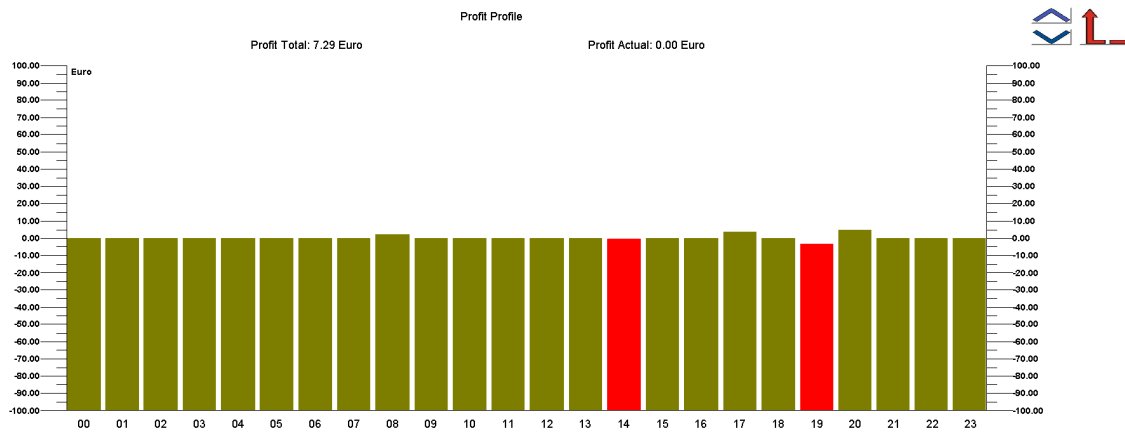

2023-09-18-08:37:50

## Battery

Clicking the Battery icon leads to the below pages where more detailed information of the PV plant can be found. Clicking the up/down arrows will browse through them.



**Production**

ACP: 67.8 kW  
 ACQ: 12.3 kVAr  
 ACS: 68.9 kVA  
 Cosphi: 0.983 C

**Produced**

ACE: 13 kWh  
 ACE YEAR: 13 kWh  
 ACE MONTH: 13 kWh  
 ACE DAY: 13 kWh

**Consumed**

ACE: 0 kWh  
 ACE YEAR: 0 kWh  
 ACE MONTH: 0 kWh  
 ACE DAY: 0 kWh

**References**

PTAR: 0.0 kW  
 PREF: 0.0 kW  
 QTAR: 0.0 kVAr  
 QREF: 0.0 kVAr

**Capacity**

SOC: 97.0 %  
 SOE: 96354.0 kWh  
 ODC: 0.0 kW  
 OCC: 0.0 kW

2023-04-16-10:58:43

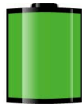

**PV charge**

Total: 0 kWh  
 Year: 0 kWh  
 Month: 0 kWh  
 Day: 0 kWh  
 Available: 0 kWh

**Mains charge**

Total: 0 kWh  
 Year: 0 kWh  
 Month: 0 kWh  
 Day: 0 kWh  
 Available: 0 kWh

**DG charge**

Total: 0 kWh  
 Year: 0 kWh  
 Month: 0 kWh  
 Day: 0 kWh  
 Available: 0 kWh

**PV discharge**

Total: 0 kWh  
 Year: 0 kWh  
 Month: 0 kWh  
 Day: 0 kWh

**Mains discharge**

Total: 0 kWh  
 Year: 0 kWh  
 Month: 0 kWh  
 Day: 0 kWh

**DG discharge**

Total: 0 kWh  
 Year: 0 kWh  
 Month: 0 kWh  
 Day: 0 kWh

2023-04-16-10:59:09

On the right hand side of the above pages one button is presented that will lead to pages with more information about.

1. Inverter data.
2. BMS data.
3. HVAC data.

## Inverter data

Clicking the inverter icon will lead to the below page where detailed information about the inverter is displayed.

**Identifiers:**

Serial: 256503  
 Model: Virtual  
 Version: 1.00.0  
 Comm ID: ID1



**Production**

ACP: 20.0 kW  
 ACQ: 0.0 kVAr  
 ACS: 20.0 kVA  
 PF: 1.0

**Capacity**

SOC: 100.0 %  
 SOE: 20.0 kWh  
 SOH: 100.0 %  
 ODC: 20.0 kW  
 OCC: 20.0 kW

**AC**

L1N: 230.9 V  
 L2N: 230.9 V  
 L3N: 230.9 V  
 L1L2: 400.0 V  
 L2L3: 400.0 V  
 L3L1: 400.0 V  
 HZ 1: 50.0 Hz  
 HZ 2: 50.0 Hz  
 HZ 3: 50.0 Hz  
 L1A: 28.9 A  
 L2A: 28.9 A  
 L3A: 28.9 A  
 LNA: 0.0 A

**AC**

ACP 1: 6.667 kW  
 ACP 2: 6.667 kW  
 ACP 3: 6.667 kW  
 ACQ 1: 0.0 kVAr  
 ACQ 2: 0.0 kVAr  
 ACQ 3: 0.0 kVAr  
 ACS 1: 6.667 kVA  
 ACS 2: 6.667 kVA  
 ACS 3: 6.667 kVA  
 PF 1: 1.0  
 PF 2: 1.0  
 PF 3: 1.0



Communication state:

Communication enable:

2021-09-20-14:20:15

**Identifiers:**



Serial: 256503  
 Model: Virtual  
 Version: 1.00.0  
 Comm ID: ID1

**Status**

CAB TEMP: 49.8 C  
 STATE: N.A.  
 EVT1: N.A.  
 EVT2: N.A.  
 EVT3: N.A.  
 EVT4: N.A.

**DC**

DCA1: 14.6 A  
 DCU1: 683.1 V  
 DCP1: 10.0 kW  
 DCA2: 14.6 A  
 DCU2: 683.1 V  
 DCP2: 10.0 kW



**Production**

ACP: 20.0 kW  
 ACQ: 0.0 kVA  
 ACS: 20.0 kVA  
 PF: 1.0

**Capacity**

SOC: 100.0 %  
 SOE: 20.0 kWh  
 SOH: 100.0 %  
 ODC: 20.0 kW  
 OCC: 20.0 kW

Communication state:   
 Communication enable:

2021-09-20-14:20:28

In the upper left corner the label of the inverter can be changed. In the lower right corner communication status for the specific inverter is shown. In case the inverter is failing to communicate for whatever reason, communication to that specific inverter can be disabled and enabled again at a later stage on the start/stop button. In the upper right corner it is possible to toggle between the pages.

Not all data shown is read/displayed from all inverter models supported and will in that case show "N.A.". Consult the Modbus master documentation on the ENcombi website for detailed information about what data is read from the various inverter models. <http://www.encombi.com/products/ecpvx/>

### BMS data

Clicking the battery icon will lead to the below page where detailed information about the BMS is displayed.

**Identifiers:**

Serial: N.A.  
 Model: N.A.  
 Version: N.A.  
 Comm ID: ID2

**Bat. modules**

Umax: 86.3 V  
 Umin: 81.3 V  
 Umax chn: 16  
 Umin chn: 9  
 Tmax: 45.3 C  
 Tmin: 44.9 C  
 Tmax chn: 12  
 Tmin chn: 9

**Status**

TEMP: 36.5 C  
 EVT1: 4  
 EVT2: 5  
 EVT3: 7  
 EVT4: 15  
 BMS STATE: 0



**Configuration**

PILES: 6  
 MODULES: 20

**Production**

DCA1: 5.6 A  
 DCU1: 786.5 V  
 DCP1: 4.4 kW

**Bat. cells**

Umax: 3365 mV  
 Umin: 3126 mV  
 Umax chn: 3  
 Umin chn: 8  
 Tmax: 46.9 C  
 Tmin: 43.2 C  
 Tmax chn: 9  
 Tmin chn: 4

**Discharge limits**

Max discharge V: 698.6 V  
 Max discharge I: 635.9 A  
 ODC: 444.2 kW

**Charge limits**

Max charge V: 789.6 V  
 Max charge I: 659.8 A  
 OCC: 520.9 kW

**Capacity**

SOC: 97.0 %  
 SOE: 96354.0 kWh  
 SOH: 96.0 %

Communication state:   
 Communication enable:

2023-04-16-10:54:56

In the lower right corner communication status for the BMS is shown. In case the BMS is failing to communicate for whatever reason, communication to that specific inverter can be disabled and enabled again at a later stage on the start/stop button.

Not all data shown is read/displayed from all inverter models supported and will in that case show "N.A". Consult the Modbus master documentation on the ENcombi website for detailed information about what data is read from the various inverter models.

<http://www.encombi.com/products/ecpvx/>

## HVAC data

Clicking the battery icon will lead to the below page where detailed information about the HVAC is displayed.

ENcombi
ADMIN

---

<b>Identifiers:</b>			
Serial:	N.A		
Model:	N.A		
Version:	N.A		
Comm ID:	ID3		

  

<b>Readings</b>		<b>Status</b>	
RETURN TEMP:	23.3 C	HVAC STATE:	6
RETURN HUMIDITY:	87.6 %	SENSOR FAULT:	false
INSIDE TEMP:	N.A.	HIGH V ALARM:	false
OUTSIDE TEMP:	N.A.	TEMP ALARM:	false
		PRES ALARM:	false
		COMP FAULT:	false
		HEAT FAULT:	false
		INT FAN ALARM:	false
		EXT FAN ALARM:	false

<b>Control</b>			
INT FAN SPD:	1198 RPM		
EXT FAN SPD:	1231 RPM		
INT FAN ON:	true		
EXT FAN ON:	true		
HEATING ON:	false		
COOLING ON:	true		

Communication state: 

Communication enable: 

2023-04-16-10:57:03

In the lower right corner communication status for the HVAC is shown. In case the HVAC is failing to communicate for whatever reason, communication to that specific inverter can be disabled and enabled again at a later stage on the start/stop button.

Not all data shown is read/displayed from all inverter models supported and will in that case show "N.A". Consult the Modbus master documentation on the ENcombi website for detailed information about what data is read from the various inverter models.

<http://www.encombi.com/products/ecpvx/>

## Load

Clicking the load icon leads to the below page where more detailed information of the load can be found.

ENcombi

ADMIN

**Consumption**

ACP: 100.0 kW  
ACQ: 10.0 kVAr  
ACS: 100.5 kVA  
Cosphi: 0.995 C

**Consumed**

ACE: 9 kWh  
ACE YEAR: 9 kWh  
ACE MONTH: 9 kWh  
ACE DAY: 9 kWh



2022-01-07-13:46:20

If Load meters are configured the respective meter button on the right hand side will become active and the meter data will be displayed in the same way as already accounted for under PV meters.



## ECpvX as power meter

An ECpvX can serve as a power meter(s) to another ECpvX. This means that one ECpvX can read the power meter data, via either Modbus RTU or Modbus TCP, polled by another ECpvX. This is useful in cases like the below examples where two PV plants are present in the same system. Both examples show inverters controlled via Modbus TCP but it could just as well have been Modbus RTU.

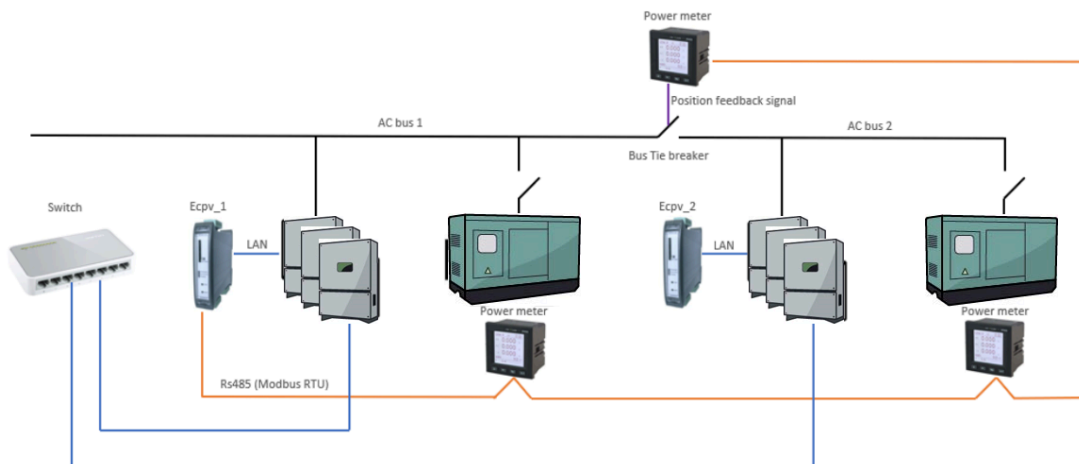
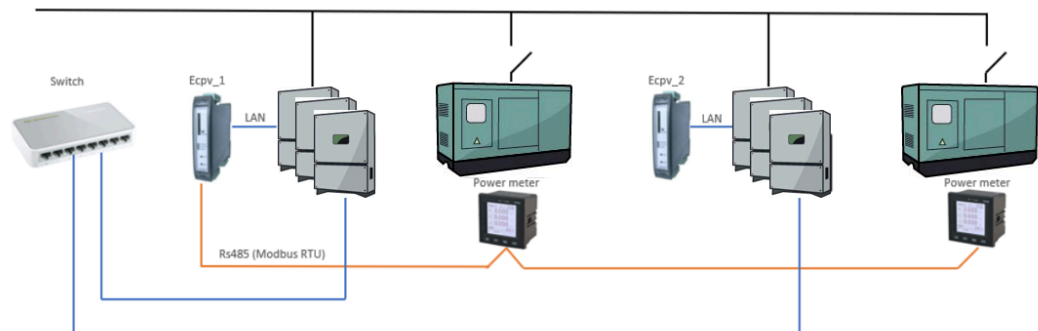

In the examples ECpv\_1 is reading the data from the power meters via Modbus RTU. ECpv\_2 is getting the same information but it is reading it via Modbus TCP from ECpv\_1.

This is a very useful feature as both ECpvXs requires the information from power meters and you would otherwise need to install an additional component in the shape of a Modbus RTU Multiplexer to allow both ECpvXs to act as Modbus Masters towards the power meters and read out the data.

It is configured in the same manner as described in the previous chapter of power meter configuration. Below is an example with genset meter configuration.

ENcombi
ADMIN

---

<b>Genset</b>			
Power meter:	ENCOMBI ECPV	<p>Genset power meter setup page.</p> <p>A maximum of 16 power meters for gensets is supported. The same make/model must be used for all genset measurements. The communication can be either Modbus RTU or TCP.</p> <p>The Modbus IDs of the meters must be sequential in case of RTU, with lowest ID being equal to the setting made in the device.</p> <p>The IP addresses of the meters must be sequential, in case of TCP, with lowest IP address being equal to the setting made in the device.</p> <p>The Modbus ID selected is used in the TCP frames.</p> <p>Port settings is setup on dedicated port setup page.</p>	
Modbus type:	TCP		
ID:	1		
IP:	192.168.1.79		
Number:	2		

2020-07-10-14:38:10

Note that the ECpvX will be reading data from multiple power meters from a single ECpv. In the above configuration the ECpvX will be reading data from two genset power meters from an ECpvX having IP address 192.168.1.79.

## ECpvX stacking

A single ECpvX can control and monitor a maximum of 32 inverters, all which must be from the same vendor and possibly of the same model. If to control more than 32 inverters or a mix of inverter makes/models multiple ECpvX's can be stacked and worked together as illustrated in the schematic below.

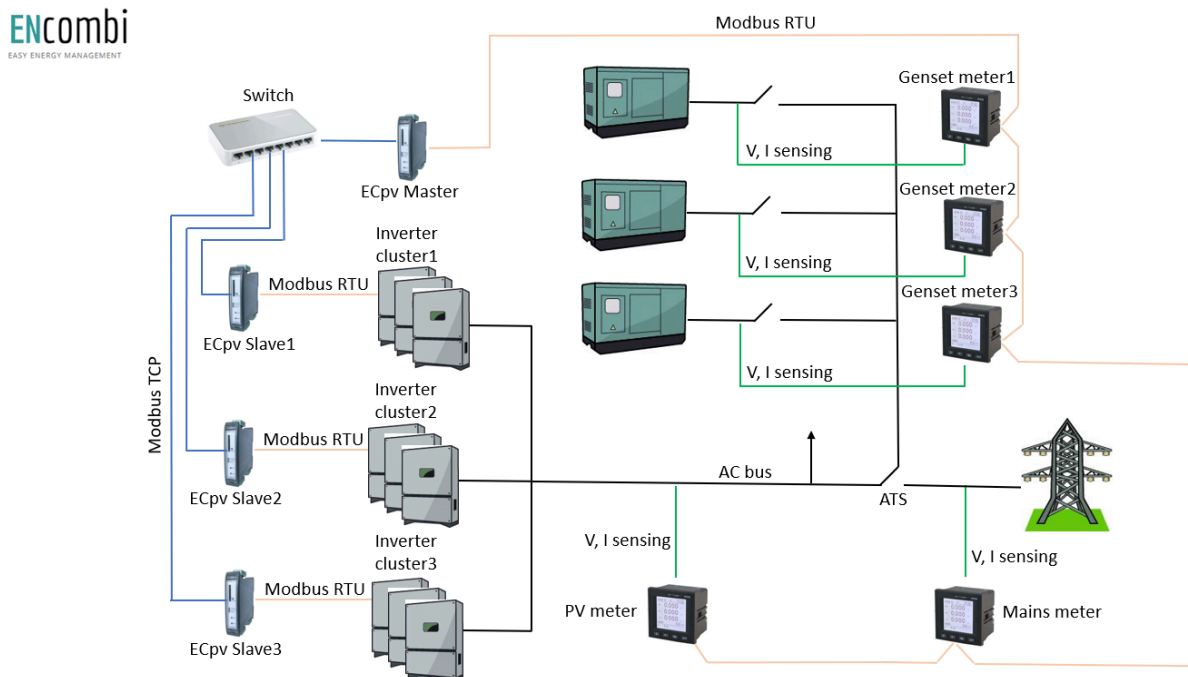

In the above example three clusters of inverters are present. These clusters can each contain up to 32 inverters and can be of another make/model than the inverters used in the other inverter clusters.

## ECpvX slave

Each cluster is controlled by a slave ECpvX. That can be via Modbus RTU as in the above example or it can be via Modbus TCP.

For PV reference under the Settings tile, these three ECpvX will be configured as being SunSpec slaves.

**ENcombi** ADMIN

**References**

Priority:	OFF
Cosphi cap:	0.600 C
Cosphi ind:	0.600 I
Cosphi lim:	DISABLED
Proprietary slave:	ENABLED
SunSpec slave:	DISABLED
Sensing method:	SUM ALL PHASES

**Measurement**

kW Origin:	PV METER
kWh Origin:	ECPV

**PV reference setup page.**  
 Priority setting determines whether to prioritise P or Q reference over the other in case exceeding rated S inverter capacity.

Cosphi cap and Cosphi ind outlines operating range of the inverters. In case enabled and reference exceeding, the device will limit the Q reference.

In case Proprietary slave is enabled, the device will accept references received from a Modbus master.

In case SunSpec slave is enabled, the device will accept references received from a SunSpec master.

Sensing method determines if to base reference on the sum of all phases or 3 x sensing values.

AC origin determines from which source the PV production arises.

kWh origin determines from which source the genset energy production arises.

2021-01-05-15:52:02

The inverter protocol itself to select in the ECpvX slaves is determined by the make/model of inverters inside their respective inverter clusters.

## ECpvX master

The fourth ECpvX will act as a normal ECpvX which interacts with the gensets and utility connections.

It will see the three ECpvX slaves simply as three (big) inverters running SunSpec, being ignorant to the fact that it is actually three clusters of inverters. Therefore, the inverter protocol to select in the master ECpvX must be SunSpec. The connection to the ECpvX slaves can be Modbus TCP as in the above example or it can be Modbus RTU.

As an ECpvX can control up to 32 inverters, the maximum capacity of an ECpvX master will be 32 inverter clusters. Should this not be sufficient, yet another ECpvX master can be applied on top of up to 32 ECpvX masters and so on.

## Genset stacking

A single ECpv2 can monitor a maximum of 16 genset power meters all which must be from the same vendor and possibly of the same model. If to monitor more than 16 genset power meters or a mix of makers/models multiple ECpv2's can be stacked and worked together as illustrated in the schematic below.

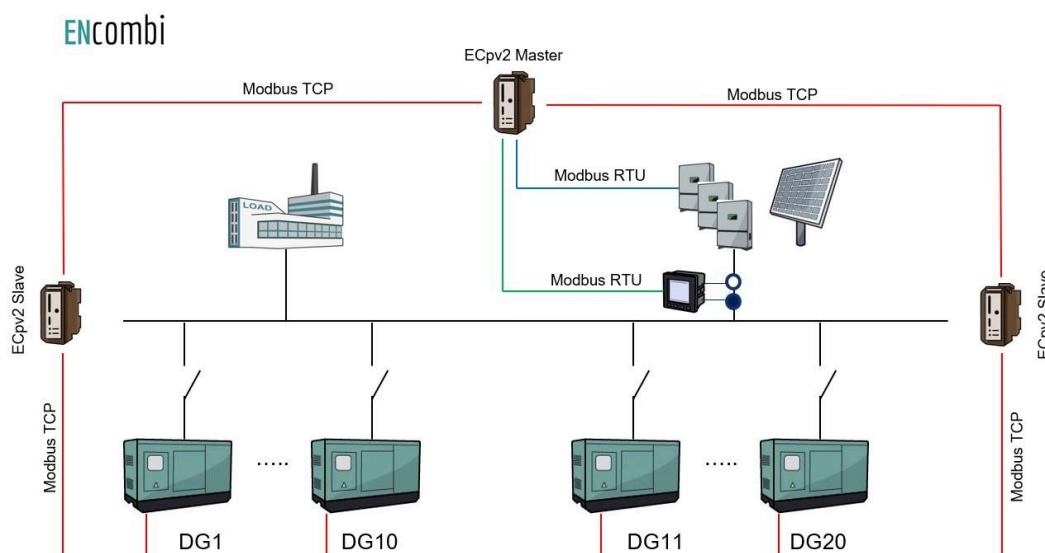

In the above example two Groups of gensets are present. These groups can each contain up to 16 genset power meters and can be of another make/model than the power meters used in the other genset groups.

### ECp2 slave

Each group is controlled by a slave ECp2. That can be via Modbus TCP as in the above example or it can be via Modbus RTU.

The genset power meter protocol itself to select in the ECp2 slaves is determined by the make/model of power meters inside their respective group.

### ECp2 Master

The third ECp2 will act as a normal ECp2 which interacts with the gensets and other connections.

It will see the two ECp2 slaves simply as two (big) gensets, being ignorant to the fact that it is actually two groups of gensets. Therefore the genset power meter protocol to select in the master ECp2 must be "ENcombi DG Group". The connection to the ECp2 slaves can be Modbus TCP as in the above example or it can be Modbus RTU.

As an ECp2 can control up to 16 genset power meters, the maximum capacity of an ECp2 master will be 16 genset groups. Should this not be sufficient yet another ECp2 master can be applied on top of up to 16 ECp2 masters and so on.

## Service Tool

First page to be displayed after an initial welcome page when switching to the Service Tool application is the front page of ECweb.

ENcombi



Select your category

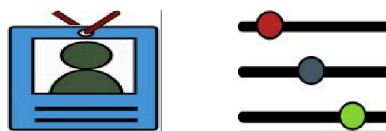

2020-07-26-10:57:51

Navigating around in the Service Tool is done in the same manner as in the ECpvX application.

In the lower center two menu tiles are available. These are from the left:

1. "Identifiers" gives access to an overview of the SW version installed as well as to the menu for switching between the applications.
2. "Settings" give access to the set up of various features.

In the following chapters the content of the two menu tiles are discussed in detail.

## Identifiers

Under this tile overview of SW version installed and extras present in the ECpvX as well as to the menu for switching between the applications.

### ENcombi

**Company:**

Name:	Website:	Contact:	Support:	Cloud service:
ENcombi	www.encombi.com	sales@encombi.com	support@encombi.com	www.encombi.online



**Product:**

Type:	Extras:	Project version:	Serial number:
ECpvX Service Tool	-C-L-	1.00.0	202105040001

**Platform:**

Device type:	Device variant:	Chip type:	Rtos:	Version:
WP240X	COM	SC24	V2.07 FULL	V23.9.63.1

**Identifiers:**

Serial number 1:	Serial number 2:	MAC address:
14738AC71464B148	37648890F9A0D012	003056914973

2021-09-20-14:22:53

On the right hand side there are one submenu for.

1. Application switch.

## Application

Clicking the Application button leads to the page below. Here it can be selected which application is to be active.

### ENcombi

**Application**

Application: ECPVX SERVICE TOOL



Application swap page.  
 Here it is set up which application to run.  
 When toggling between applications, the device is to be reboot. Any settings made in the ECpvX application will be lost in the process. Store a backup before leaving the ECpvX project if any settings are made that is to be restored when reverting to the ECpvX application. Browser needs refreshing when the device has rebooted.

2021-09-20-14:23:22

The following applications are available.

1. ECpvX.
2. ECpvX Service Tool.
3. ECpvX Boot.

ECpvX is the default application and the one to use for the normal operation of the ECpvX. ECpvX Service Tool is a separate application that offers various tests and configuration features and the ECpvX Boot is a tool for updating both the ECpvX and the ECpvX Service Tool SW.

When toggling between applications the device is to be rebooted. Any settings made in the ECpvX application will be lost in the process. Make a backup before leaving the ECpvX application if any settings are made that are to be restored when reverting to the ECpvX application once again. The browser needs refreshing when the device is rebooted after switching the application.



## Settings

Under this tile the setup of various features are found.

First page presented when clicking the Settings tile is the page below where COM2 configuration is set up.

### ENcombi

#### COM2 port

Baudrate:	19200
Parity:	NO PARITY 1 STOP BIT
Timeout:	1.0 s
TX rate:	1.0 s
Slave ID:	1



COM2 Port setup page.  
Baudrates supported are 9600, 19200, 38400 and 115200.  
Power meter RTU communication is fixed on COM2.  
Sensor and IO module RTU communication is optional on COM2.  
In case none of these communications are enabled, COM2 is serving as a Modbus RTU slave.  
Slave ID is only used in case COM2 is serving as a slave.



2022-03-11-15:08:56

Baud rates supported are:

- 9600, 19200, 38400 and 115200

Parity supported are:

- "Parity one stop bit", "No parity", "Even parity" and "Odd parity".

On the same menu level, a similar setup page for COM3 configuration is found. Clicking the up/down arrows will lead to it.

On the right hand side there are two submenus for.

1. Power meter configuration.
2. IO modules
3. Modbus Tester.
4. Client Trace.

### Power meter configuration

Power meter configuration allows you to read and write the configurations of various power meters over Modbus. Clicking the Power meter button leads to the page below where a Pilot SPM32 power meter can be configured.

### SPM32 config

Baudrate:	9600	
CT ratio:	1	
VT ratio:	1	
Conn mode:	3 Phase 4 Wire	
Modbus ID:	1	1

SPM32 setup page.  
 Here a SPM32 power meter can be set up.  
 It is fixed to use COM2.  
 Port settings is setup at dedicated port setup page.  
 Connect A(-) on the ECpv to RS485+ on the SPM32 and  
 Connect B(+) on the ECpv to RS485- on the SPM32.  
 Note that the SPM32 Modbus ID is set via the  
 dipswitches on the back side.

2020-07-31-13:18:19

Clicking up/down buttons will navigate through all the meter power meter configurators supported. Currently the following are supported:

1. Pilot SPM32.
2. Pilot SPM33.

## IO configuration

IO configuration allows you to read and write the configurations of IO modules over Modbus. Clicking the IO button leads to the page below where COM2 or COM3 can be selected.

### IO modules

COM port:	COM2	
-----------	------	--

IO module setup page.  
 IO module communication can either run Modbus RTU or Modbus TCP.  
 Whether to use COM2, COM3 or TCP is selectable by parameter.  
 Port settings is setup at dedicated port setup page.

2021-09-20-14:29:30

Afterwards clicking on the IO configuration button on the right hand side leads to the IO configuration page.

ENcombi

---

IO module comm.

Baudrate: 9600

Parity: EVEN PARITY

Modbus ID: -

Timeout: -

IO module search

Modbus ID: 1

Module: N.A

FW version: N.A

Overdigit IO module communication setup page.

After IO module is powered up, then press the PG button on the IO module for 3s until the green LED starts flashing. Now the IO module is in a temporary state having the Baudrate and Parity listed in the colored Active Column. Note that the COM port selected for IO module communication must be configured accordingly to complete the configuration successfully. In the update column the requested communication setup is made and Save button is pushed to write it to the IO module. Afterwards, press the PG button again to stop the green LED flashing and activate the communication setup just made.

The Timeout determines the delay for no communication being active before the IO module releases all its relays. Setting it to "0 x 10ms" means disabling the functionality and the IO module will keep the relays at there states in case of communication loss.

Search a Modbus ID to find module type and firmware version.

2022-02-07-14:32:39

It is possible to set up the Overdigit IO module with the tool.

After the IO module is powered up, then press the PG button on the IO module for 3s until the green LED starts flashing. Now the IO module is in a temporary state, having the Baudrate and Parity listed in the colored Active Column. Note that the COM port selected for IO module communication must be configured accordingly to complete the configuration successfully. In the update column the requested communication setup is made and the Save button is pushed to write it to the IO module. Afterwards, press the PG button again to stop the green LED flashing and activate the communication setup just made.

The Timeout determines the delay for no communication being active before the IO module releases all its relays. Setting it to "0 x 10ms" means disabling the functionality and the IO module will keep the relays at their states in case of communication loss.

## AIO

When pressing the settings icon, it will lead to the following page.

### ENcombi

#### EX04AIO config

Channel 1 type:	OFF
Channel 1 source:	0-10V
Channel 2 type:	OFF
Channel 2 source:	0-10V
Channel 3 type:	OFF
Channel 3 source:	0-10V
Channel 4 type:	OFF
Channel 4 source:	0-10V
Modbus ID:	-



Overdigit AIO module communication setup page.  
 Here an EX04AIO can be set up.  
 It is optional which port to use. It is setup at dedicated COM page.  
 Port settings is setup at dedicated port setup page.  
 Setup input and output for all 4 channels.  
 Modbus ID needs to be set in order to write configuration.

2022-02-07-14:34:29

From there it is possible to set up an EX04AIO module. From here it is selectable which channel to use for input and output. All 4 channels can be selected as off, input and output. It is also selectable which source the input or output should work with. The two options are 0-10 or 4-20mA. When the configuration is ready, the modbus ID must be set and after that it is possible to write the configuration to the module. An icon will show if the writing was successful or failed.

Toggle to the next page will lead to the set up of EX04AIS.

### ENcombi

#### EX04AIS config

Channel 1 source:	OFF
Channel 2 source:	OFF
Channel 3 source:	OFF
Channel 4 source:	OFF
Modbus ID:	-



Overdigit AIS module communication setup page.  
 Here an EX04AIS can be set up.  
 It is optional which port to use. It is setup at dedicated COM page.  
 Port settings is setup at dedicated port setup page.  
 Setup input for all 4 channels.  
 Modbus ID needs to be set in order to write configuration.

2022-02-08-09:42:21

These are only inputs, so the only configuration is which source the channels should be. It can also be selected as OFF, which means the channel is deactivated.

## Sensor Configuration

The Sensor configuration allows you to read and write the configurations of various sensors over Modbus. Clicking the Sensor button leads to the page below where it is set up whether the Sensor configuration is to use COM2 or COM3.

### ENcombi

Sensors

COM port: COM2



Sensor setup page.  
Sensor communication is running Modbus RTU only.  
Whether to use COM2 or COM3 is selectable by parameter.  
Port settings is setup at dedicated port setup page.



2022-03-11-15-07:41

Afterwards, clicking on the setup button on the right hand side leads to the Sensor configuration itself where the Sensor modules communication settings can be adjusted and the Sensor modules can be searched and identified.

### ENcombi

SolSolare config

Baudrate: N.A.  
Parity: N.A.  
Modbus ID: N.A.  
Serial: N.A.  
FW main: N.A.  
FW minor: N.A.

60



Soluzione Solare setup page.  
Here the Soluzione Solare sensors can be set up.  
Port settings are setup at dedicated port setup pages.  
Connect A(-) on the ECpv to RS485+/B on the sensor and  
Connect B(+) on the ECpv to RS485-/A on the sensor.



2022-03-11-15-08:02

## Modbus Tester

Modbus Tester is a feature where the Service Tool acts as a Modbus RTU Master and communication with a Modbus RTU Slave can be tested. Clicking the Modbus Tester button leads to the page below where it is set up whether the Modbus Tester is to use COM2 or COM3.

### Modbus tester

COM port: COM2



Modbus test page.  
Here read and write commands can be tested.  
The Modbus tester is for Modbus RTU only.  
Whether to use COM2 or COM3 is selectable by parameter.  
Port settings is setup at dedicated port setup page.



2020-07-26-11:17:56

Afterwards, clicking on the Modbus Tester button on the right hand side leads to the Modbus Tester itself where Modbus RTU read and write commands of various length and function codes can be transmitted and the response received is shown.

**Read**

Start ID:	Stop ID:	Control Fnc:	Control Fnc:	Control Fnc:	Address:	Length:
1	1	0x03	16BIT	SIGNED	0	1
N.A	N.A	N.A	N.A	N.A	1	N.A
N.A	N.A	N.A	N.A	N.A	N.A	
Register 1..2	Register 3..4	Register 5..6	Register 7..8	Register 9..10	Byte 01..20	

**Write**

Modbus ID:	Control Fnc:	Control Fnc:	Control Fnc:	Address:	Command:
1	0x06	16BIT	SIGNED	0	0
UNICAST	N.A				

2022-03-11-14:56:43



## Client trace

Clicking the Client Trace button leads to the page below where trace of Modbus communication can be enabled/disabled. The Modbus Tester only shows the result/content of valid Modbus frames received. The Trace, on the other hand, provides information on any communication being detected on the RS485 line even if it is not perceived as valid Modbus frames.

### ENcombi

**Trace**

Modbus:                   DISABLED

Trace setup page.  
Enabling/disabling trace of various device client activities.  
Trace is readable via device Telnet server.



---

2020-07-26-11:35:57

Trace is available via the built-in Telnet server. Clicking on the Telnet server button on the right hand side leads to the Telnet server setup.

## Telnet server

On the page below the telnet server access is set up.



### ENcombi

**TELNET Server:**

User0:                   telnet\_user0

Password0:               \*\*\*\*\*

Telnet:                   ENABLED

Telnet server setup page.  
Credential is for device telnet server access.  
Telnet is usable for tracing various device client activities.



---

2020-07-10-13:14:30

Use the PC application "Chiptool" to connect to the Telnet Server to follow activities such as the Modbus trace.

## Boot

First page to be displayed after an initial welcome page when switching to the Boot application is the front page of ECweb.

ENcombi



Select your category



---

2021-02-02-13:42:34

Navigating around in the Service Tool is done in the same manner as in the ECpv application.

In the lower center one menu tile is available:

1. "Identifiers" gives access to an overview of the SW version as well as to the menus for updating SW and switching between the applications.

In the following chapters the content of the menu tile is discussed in detail.



## Identifiers

Under this tile overview of SW version installed and extras present in the ECpvX.

### ENcombi

**Company:**

Name:	Website:	Contact:	Support:	Cloud service:
ENcombi	www.encombi.com	sales@encombi.com	support@encombi.com	www.encombi.online



**Product:**

Type:	Extras:	Project version:	Serial number:
ECpvx Boot	-C-L-	1.00.0	202105040001

**Platform:**

Device type:	Device variant:	Chip type:	Rtos:	Version:
WP240X	COM	SC24	V2.07 FULL	V23.9.63.1

**Identifiers:**

Serial number 1:	Serial number 2:	MAC address:
14738AC71464B148	37648890F9A0D012	003056914973

2021-09-20-14:36:07

On the right hand side there are submenus for.

1. SW update.
2. Application switch.

## SW update

Clicking the SW update button leads to the page below. From here the ECpvX and the ECpvX Service Tool SW can be updated from a USB stick.

### ENcombi



Device project update via USB.

- 1: Create an empty folder on your laptop named ECpvx\_SW.
- 2: Download the SW file from the website.
- 3: Unzip the downloaded file.
- 4: Navigate to the SW version folder.
- 5: Copy the content of the SW version folder.
- 6: Paste the content to the ECpvx\_SW folder.
- 7: Copy the ECpvx\_SW folder to the root of a USB stick.
- 8: Insert USB stick into the device.
- 9: Click the search for SW button.
- 10: Wait for the process to complete.
- 11: If completed successfully then revert to the ECPVX application.



2021-09-20-14:47:23

Download the SW from the website and place it in a folder named "ECpvx\_SW" in the root of a USB stick like shown below:

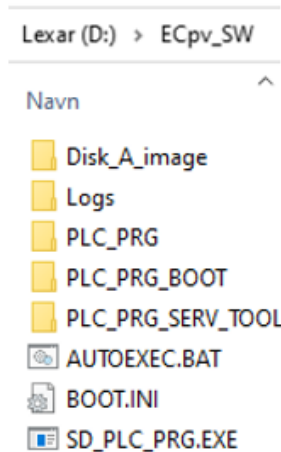

Then insert the USB stick into the ECpvX and press the binoculars button to start the SW update. When the SW update is completed successfully, then you can safely revert to the ECpvX application. If the SW is interrupted and it fails, then remain in the Boot application and try to update the SW once again. Do not return to the ECpvX application until the SW update is completed successfully.

## Application

Clicking the Application button leads to the page below. Here it can be selected which application is to be active.

## ENcombi

### Application

Application: ECPVX BOOT



Application swap page.  
Here it is set up which application to run.  
When toggling between applications, the device is to be rebooted. Any settings made in the ECpvX application will be lost in the process. Store a backup before leaving the ECpvX project if any settings are made that is to be restored when reverting to the ECpvX application.  
Browser needs refreshing when the device has rebooted.

2021-09-20-14:48:01

The following applications are available.

1. ECpvX.
2. ECpvX Service Tool.
3. ECpvX Boot.

ECpvX is the default application and the one to use for the normal operation of the ECpvX. ECpvX Service Tool is a separate application that offers various tests and

configuration features and the ECpvX Boot is a tool for updating both the ECpvX and the ECpvX Service Tool SW.

When toggling between applications the device is to be rebooted. Any settings made in the ECpvX application will be lost in the process. Make a backup before leaving the ECpvX application if any settings are made that are to be restored when reverting to the ECpvX application once again. The browser needs refreshing when the device is rebooted after switching the application.