



ECpv2

User manual

Document change log	5
Introduction	6
ECweb	8
Connecting to ECweb with Internet Explorer or Pale Moon browser on PC/laptop	8
Connecting to ECweb using any other browser or mobile device	8
Troubleshooting	9
Navigating the ECweb	10
Control	12
IP configuration	12
Internal clock	12
NTP synchronization	12
Manual time adjustment	13
FTP client	13
FTP server	14
Automatic FTP transfer	14
ECpv2 server access	14
ECpv2 FTP server	15
ECpv2 Telnet server	15
ECpv2 web server (ECweb)	17
Identifiers	18
ECpv2 information	18
Project details	18
Password scheme	19
Passwords	20
Permissions	21
License & Extras	22
Search online	22
Search on USB	22
Metrics	23
Backups	24
Application	25
Settings	26
RS485 COM ports	26
PV	28
Ratings	28
Measurements	28
Reference	30
Ramp rates	31
Ramp threshold	32

Tariff	32
Counters	34
Meter	35
Relay	36
CT settings	36
Frame settings	37
Inverter	38
RTU	38
TCP	39
Advanced Inverter command setup	41
Common inverter command setup	41
SunSpec inverter command setup	42
Secondary inverter setup	42
Multiple inverter cluster setup	43
Inverter PID control	44
Genset	46
Measurements	46
References	49
Tariffs	49
Rated sizes	51
Counters	51
Meter	52
Genset management	52
Load dependent start/stop	52
Non-sync.	53
Sync SR.	54
Genset start/stop failures	55
Mains	56
Measurements	56
References	58
API	60
Tariffs	60
Rated sizes	61
Counters	61
Meter	62
Grid support	62
Grid support P(f)	63
Grid support U(Q)	64
Load	65
Load meter for control	66
Sensors	67

Modbus RTU Sensors	67
PV generating capacity	68
IO modules	69
Analogue input/output	70
Alarms	71
Genset low power	72
Mains low power	73
COM2 slave	73
COM3 slave	74
TCP slave	74
Fuel level alarm	75
Inverter production deviation alarm	75
Common master communication	76
Modbus Master comm. alarms	76
Overview	77
Nighttime	78
Simulation	79
Proprietary modbus pages	80
Monitoring	81
Logs	82
Local logs with transmission via ftp	82
Log to MySQL database	84
EClogic	85
Builder	85
Example	87
Linker	87
Example continued	88
Overruling of Settings parameters	88
General Purpose Hysteresis	90
RRCR	91
AIO	93
Sensor	93
IO	94
Command timers	94
Command panel	95
General purpose alarms	96
General purpose timers	96
Monitoring	98
Command panel	99
Sensor data	99
IO module data	100

Simulation	101
PV	102
PV meter data	104
Inverter data	105
Genset	106
Genset meter data	106
Mains	107
Mains meter data	107
Spot price market data	107
Load	108
ECpv2 stacking	111
Inverter stacking	111
ECpv2 slave	111
ECpv2 Master	112
Genset stacking	112
ECpv2 slave	113
ECpv2 Master	113
Service Tool	114
Identifiers	115
Application	115
Settings	117
Power meter configuration	117
IO configuration	118
AIO	120
Sensor Configuration	121
Modbus Tester	121
Client trace	123
Telnet server	123
Boot	124
Identifiers	125
SW update	125
Application	126

Document change log

2022-06-28	First version
2022-07-11	Updated for version 1.01.0
2022-07-14	Updated for version 1.02.0
2022-09-27	Updated for version 1.04.1
2022-10-12	Updated for version 1.05.0
2022-10-31	Updated for version 1.06.0
2022-11-08	Updated for version 1.07.0
2023-04-03	Updated for version 1.12.0
2023-05-23	Updated for version 1.13.0
2023-09-05	Updated for version 1.16.0
2023-10-25	Updated for version 1.17.0
2024-01-15	Updated for version 1.18.0
2024-04-03	Updated for version 1.22.0
2024-04-10	Updated for version 1.24.0
2024-04-12	Updated for version 1.25.0
2024-04-16	Updated for version 1.26.0
2024-08-08	Updated for version 1.29.2
2024-08-21	Updated for version 1.31.0

Introduction

The ECpv2 from ENcombi is capable of controlling the production of PV inverters synchronized to grid and/or gensets. The ECpv2 is agnostic in the sense that it integrates with PV inverters, gensets, meteorological sensors and power meters independent of vendor and model.

The production of the PV inverters are controlled seamlessly via a communication interface to the PV inverters. This interface can be either via Modbus RTU running on serial RS485 line or via Modbus TCP running on ethernet dependent on the PV inverter vendor and model used.

The same can be said of the interfaces to genset controller and power meters, these can be interfaced to also via Modbus RTU running on serial RS485 line or via Modbus TCP running on ethernet dependent on the vendors and models used.

Meteorological sensors are interfaced via Modbus RTU running on serial RS485 line only.

All interfaces for both PV inverters, gensets, power sensing meters and meteorological sensors are pre-embedded and are enabled merely by parameter setting.

All configuration and real time monitoring of the ECpv2 is done by connecting with a standard web browser to its built-in webserver (ECweb). Comprehensive help texts guide you through the configuration setup. ECweb can run on any device featuring a web browser. Use for instance a panel PC as a local HMI. A laptop or portable device which will give you monitoring and control capabilities even from a remote, if connectivity to the ECpv2 is in place.

It is not mandatory for the control and balancing of the PV, genset and Mains part to work to have HMI or laptop connected to ECweb. It is required for commissioning of the ECpv2 only.

Besides doing the control and balancing of the PV, genset and Mains the ECpv2 is also acting as a datalogger. The ECpv2 can make local file loggings on the SD card or an USB memory stick. These logs can be sent to the customer ftp server. Furthermore the ECpv2 can push data to a MySQL server hosted either by ENcombi with ENcombi front-end for data visualization (ECcloud) or customers can choose to push data to their own database and make use of their own data visualization tool.

Data logging functionality and connectivity to the internet is not mandatory for the control and balancing of the PV, genset and Mains part to work.

Below schematics are examples of how ECpv2 are fitted into and interconnected to its surrounding environment.

Modbus RTU inverters

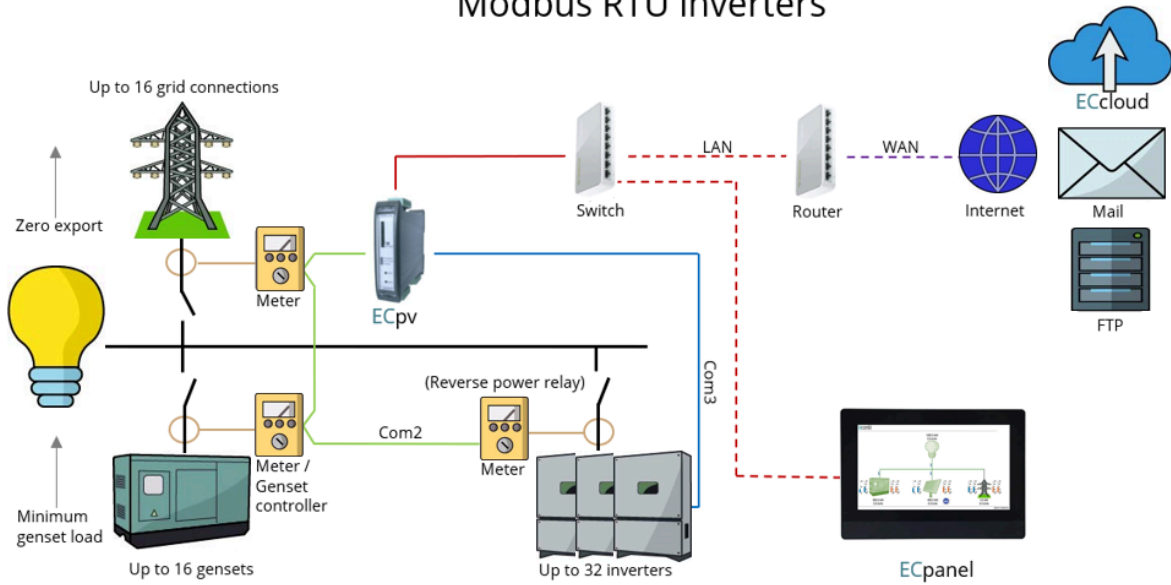

Modbus TCP inverters

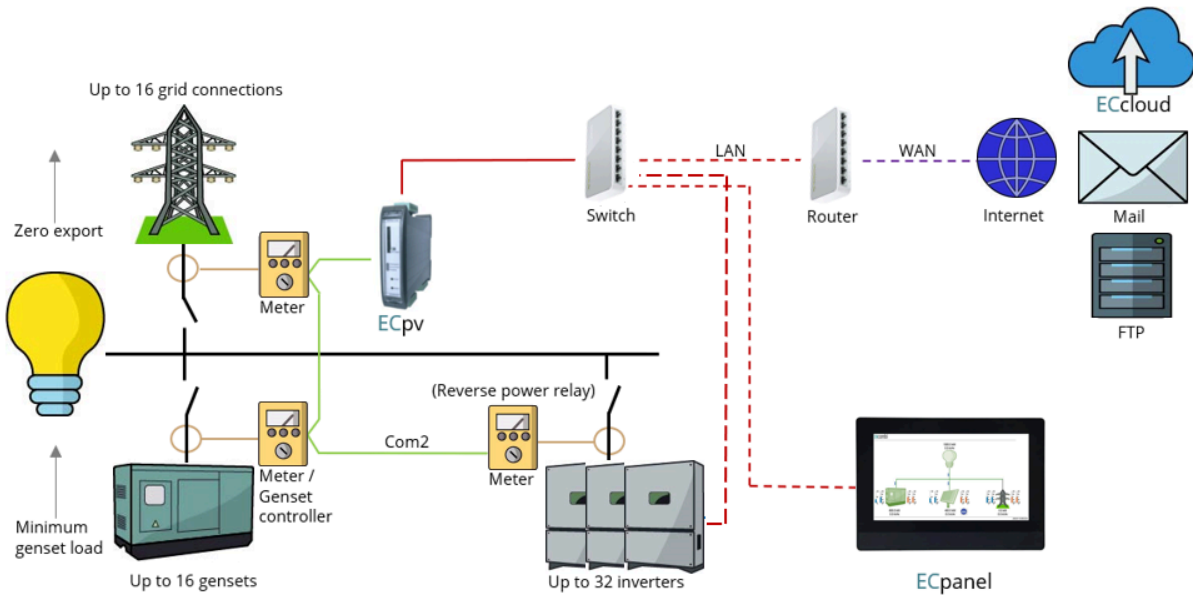

ECweb

ECweb is the built-in webserver of the ECpv2. All configuration and real time monitoring of the ECpv2 is done via ECweb. Connection to ECweb is done with a standard web browser

Using a laptop/PC and Internet Explorer browser running on Java is the best option for connecting to ECweb. Other browsers and mobile devices can be used as well.

Connecting to ECweb with Internet Explorer or Pale Moon browser on PC/laptop

Java from oracle must be installed on PC/laptop. Java can be downloaded from the link below. Note that either the Internet Explorer or the Pale Moon browser must be used for the download.

[Java download](#)

1: Type in IP address of the ECpv2 in the browser command line.

Default IP address is:

192.168.1.101.

2: Type in login credentials when prompted.

Default login credentials are:

user: web_user0

password: web_password0

3: Accept/Ignore all warnings populated.

4: If tiles on the front page are out of order, click on the page and they will fall into place. If any Icons are missing on the tiles, restart the browser and start over.

Connecting to ECweb using any other browser or mobile device

For all other browsers on PC/laptop or from any browser on mobile devices.

1: Type in IP address/webvisu.html in the browser command line.

Default IP address is:

192.168.1.101.

2: Type in login credentials when prompted.

Default login credentials are:

user: web_user0

password: web_password0

Troubleshooting

If connection can't be established verify that:

1. ECpv2 is powered up and running. ECpv2 must have 24VDC (+/- 15%) supply voltage. The green Power and the green Run LEDs in the front of the ECpv2 must both be illuminated. Note that a too low supply voltage can result in a situation where sufficient voltage is present to power up the ECpv2 but not to run the program. In this case the Power LED is illuminated but the Run LED. When powering up the ECpv2 the Power LED will light up first and the Run LED will come approximately 30s after when ECpv2 is initialized and the program is up and running.
2. Your laptop must be on the same subnet as the ECpv2. Even though you have an ethernet cable going directly from your laptop to the ECpv2 you still need to make sure that your laptop is provided with a suitable IP address. In the case where the default IP address of the ECpv2 192.168.1.101 is kept a suitable IP address for your laptop would be 192.168.1.x, where x is a number in the range [2;249] excluding "101" as this is used by the ECpv2 itself.
3. Once the IP of your laptop is in place you must be able to ping the ECpv2. This can be done by opening a command prompt and writing the command "ping xxx.yyy.zzz.www" where xxx.yyy.zzz.www is the IP address of the ECpv2 as shown below. First when the ECpv2 replies to the command it is verified that your laptop and the ECpv2 can see each other on the network and you can connect to ECweb using the browser as described above.

```
C:\Users\Claus>ping 192.168.1.101

Pinging 192.168.1.101 with 32 bytes of data:
Reply from 192.168.1.101: bytes=32 time=15ms TTL=255
Reply from 192.168.1.101: bytes=32 time=25ms TTL=255
Reply from 192.168.1.101: bytes=32 time=1ms TTL=255
Reply from 192.168.1.101: bytes=32 time=11ms TTL=255

Ping statistics for 192.168.1.101:
    Packets: Sent = 4, Received = 4, Lost = 0 (0% loss),
    Approximate round trip times in milli-seconds:
        Minimum = 1ms, Maximum = 25ms, Average = 13ms
```

Navigating the ECweb

First page to be displayed after an initial welcome page when connection is established is the front page of ECweb.

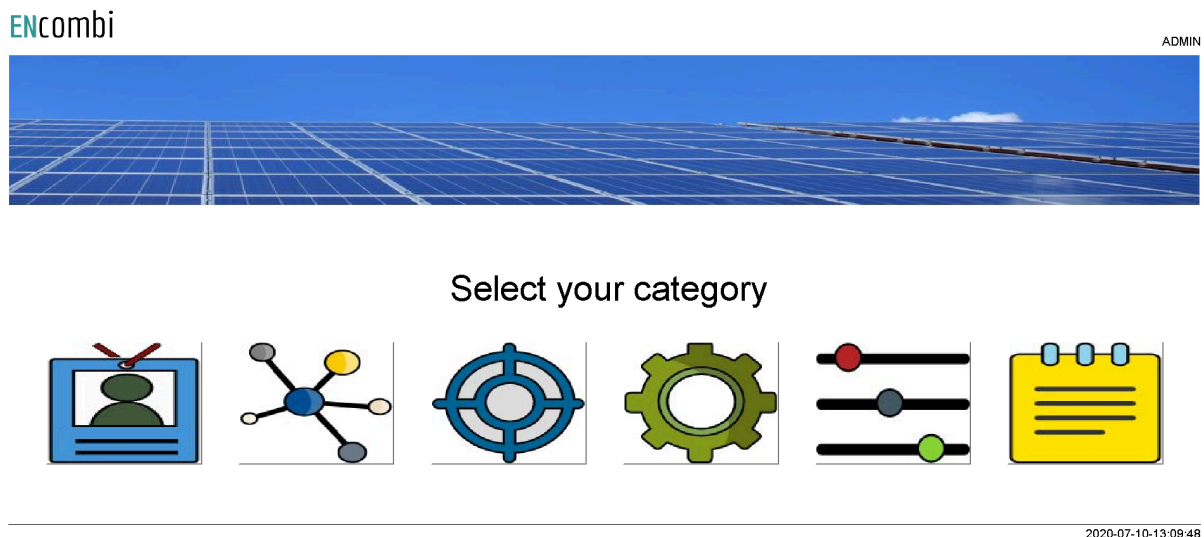

Whenever navigating around the ECweb you can always return to this page by clicking the ENcombi logo in the upper left corner.

In the upper right corner you can see the current access login level. Find more information about this in the chapter revolving password scheme.

In the lower left corner ECpv2 will display any info and warning messages it wants to communicate to the user. Some messages will clear themselves automatically. Others demand user action to be acknowledged first. In that case a dedicated button with a garbage can symbol will be presented alongside the messages. Furthermore when changing certain settings etc. a reboot of the ECpv2 is required before the changes take effect. This will be communicated in the message as well and a dedicated button with a refresh symbol will be presented alongside the messages.

In the lower right corner is the internal clock of the ECpv2 displayed.

In the lower center a total of six menu tiles are available. These are from the left:

1. "Identifiers" gives access to an overview of the SW version installed and extras present in the ECpv2 as well as set up of project details (name, location etc.), password scheme etc.
2. "EClogic" provides the possibility of making project specific logical expressions when required. That could be for linking physical digital inputs applied on power meters to the position of breakers or similar. Also here, RRCR can be set up

providing the option of a superior control system to give power references for the ECpv2 to follow.

3. "Monitoring" provides a high level overview of the installation as well as detailed information about each individual inverter and power meter.
4. "Control" gives access to set up of ECpc controller related parameters such as IP configuration, Internal clock handling etc.
5. "Settings" give access to setup of site specific parameters such as number and ratings of genset, grid connections, and inverters, which power meters are used, power and reactive control schemes etc.
6. "Logs" give access to the setup of log specific parameters.

In the following chapters the content of the six menu tiles are discussed in detail.

Control

Under this tile set up of ECpc controller related parameters for IP configuration, Internal clock handling etc. are found.

IP configuration

First page presented when clicking the Control tile is the below page where IP configuration is set up and connectivity to the gateway can be tested.

ENcombi ADMIN

IP config

IP address: 192.168.1.62

Netmask: 255.255.255.0

Gateway: 192.168.1.1

DNS config

DNS server 01: 8.8.8.8

DNS server 02: 8.8.4.4

IP setup page.
Connectivity to gateway and DNS server can be tested.

Test: 192.168.1.1

2024-08-08-10:18:17

On the right hand side there are three submenus for.

1. Internal clock.
2. FTP client.
3. ECpv2 server access.

Internal clock

The internal clock can be synchronized against an NTP server as well as be set manually.

NTP synchronization

First page presented when clicking the clock button is the below page where NTP synchronization can be set up and connectivity to an NTP server and its functionality can be tested.

NTP config

NTP address 1: dk.pool.ntp.org
 NTP address 2: 81.88.24.155
 UTC: 1
 Daylight: EUROPEAN
 NTP sync hour: 0:00
 NTP: ENABLED



NTP setup page.
 Connectivity to an NTP server can be tested.

Test:

188.40.88.13



2020-07-10-13:10:47

On the same submenu level the manual time adjustment of the internal clock is found. Clicking the up/down arrows will lead to it.

Manual time adjustment

On the page below the internal clock can be set manually. The time of the PC connected is presented and can be used to set the ECpv2 clock against.

Manual config

PC time: 2020-07-10-13:11:14

PLC time:

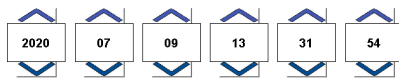

Manual device clock adjustment.
 PC time shown for reference.

2020-07-10-13:11:12

FTP client

The ECpv2 has an FTP client and can transfer logs to an FTP server. It can be set up to do so automatically in case of an event/alarm occurring as well as transferring the summary and production logs when completed. This is discussed in detail in the Logs chapter later in this document. The customer/installer must make use of their own FTP server.

FTP server

First page presented when clicking the FTP button is the page below where the FTP server details are set up. Connectivity to FTP server as well as functionality can be tested.

ENcombi ADMIN

FTP config

FTP server: myftpserver.com

FTP path:

FTP client port: 21

FTP passive: ENABLED

FTP username: username

FTP password: *****

Test: myftpserver.com

FTP setup page.
 Path to sub folder on FTP server can be setup.
 Path must be provided as indicated in below example.
 /Folder/SubFolder/.
 No path entered equals FTP server root directory.
 Connectivity to a FTP server can be tested.
 Transfer of an empty file FTPTest.txt can be tested.

2020-07-10-13:12:58

On the same submenu level the set up of automatic FTP transfer is found. Clicking the up/down arrows will lead to it.

Automatic FTP transfer

On the page below the automatic transfer of files is set up.

ENcombi ADMIN

Auto FTP

Event log: DISABLED

Summary log: DISABLED

Production log: DISABLED

Attempts: 3

Automatic FPT file transfer setup page.
 Transmission of event log file can be triggered by
 occurrence of alarms and/or events.
 Transmission of summary log will occur
 at midnight containing days result.
 Transmission of production log will occur
 at midnight containing full days production.
 Number of re-transmission attempts can set.

2020-07-10-13:13:25

ECpv2 server access

The ECpv2 features three servers:

1. FTP server.
2. Telnet server.
3. Web server (ECweb).

ECpv2 FTP server

First page presented when clicking the server button is the page below where the FTP server access details are set up.

Two sets of credentials exist.

1. Credential set0 will provide access to the PLC_PRG folder on the SD-card.
2. Credential set1 will provide access to the Logs folder on the SD-card.

FTP server access in general can furthermore be enabled/disabled.

ENcombi ADMIN

FTP Server:

User0: ftp_user0

Password0: *****

User1: ftp_user1

Password1: *****

FTP: ENABLED

FTP server setup page.
 Credential0 is for remote SW update via FTP.
 Credential1 is for reading out logs via FTP.

2020-07-10-13:14:07

On the same submenu level the set up of telnet server access is found. Clicking the up/down arrows will lead to it.

ECpv2 Telnet server

On the below page the telnet server access is set up. It is normally not used as it is intended for debug purposes only by tracing various ECpv2 client activities. Telnet server access in general can furthermore be enabled/disabled.

TELNET Server:

User0: telnet_user0
Password0: *****
Telnet: ENABLED



Telnet server setup page.
Credential is for device telnet server access.
Telnet is usable for tracing various device client activities.

2020-07-10-13:14:30

On the same submenu level the set up of web server access is found. Clicking the up/down arrows will lead to it.

ECpv2 web server (ECweb)

On the page below the web server access is set up.

The HTTP port can be changed. This can be useful if to access ECpv2 from outside the LAN using port forwarding and multiple ECpv2's or other devices also featuring a web server are connected to the LAN as well.

ENcombi

ADMIN

WEB Server:

User0: web_user0

Password0: *****

HTTP port: 80

WEB server setup page.
Credential is for device WEB server access.
The HTTP port can be changed which can be useful if to setup
port forwarding in a router/gateway to the device.

2020-07-10-13:14:49

Identifiers

Under this tile overview of the SW version installed and extras present in the ECpv2 as well as set up of project details (name, location etc.), password scheme etc. are found.

ECpv2 information

First page presented when clicking the Identifiers is the below page where various details about the ECpv2 such as extras available, SW version, serial number etc. Also the MAC address can be found which is to be used when registering the ECpv2 in ECcloud.

The screenshot shows the ENcombi web interface. At the top left is the ENcombi logo. At the top right is an 'ADMIN' link. The main content is organized into several sections:

- Company:**
 - Name: ENcombi
 - Website: www.encombi.com
 - Contact: sales@encombi.com
 - Support: support@encombi.com
 - Cloud service: www.encombi.online
- Product:**
 - Type: ECpv
 - Extras: -C-H-L-
 - Project version: 1.27.0
 - Serial number: 201901030001
- Platform:**
 - Device type: WP240
 - Device variant: COM
 - Chip type: SC24L
 - Rtos: V2.05 FULL
 - Version: V23.9.60.1
- Identifiers:**
 - Serial number 1: DF7BC72FA82129E4
 - Serial number 2: 5E8BF29E33F0FABB
 - MAC address: 0030569108A2

On the right side of the interface, there are five submenus represented by icons: a location pin, a document with a green arrow, a blue circle with three horizontal lines, a yellow star, and a blue square with a white arrow.

At the bottom right of the page, the date and time '2020-07-25-20:24:51' are displayed.

On the right hand side there are five submenus for.

1. Project details.
2. Password scheme.
3. Extras.
4. Metrics.
5. Backups.
6. Application

Project details

Clicking the location button leads to the below page where project details such as site name and location can be entered. Site name as well as location information is used when registering ECpv2 in ECcloud as well as for data visualization in ECcloud after registration.

Project details:

Site: Holstebrovej 75
 Customer: Sterregaards
 Installer: Claes
 Install date: 2018-03-04



Site details setup page.
 The site name will be used by the device as the
 "from-alias" when sending out Emails.

Location details:

Country: Denmark
 Region: Midtjylland
 City: Viborg
 Latitude: 56.4483
 Longitude: 9.3786

2020-07-10-13:19:03

Password scheme

Clicking the log-in button leads to the below page where the password scheme can be enabled/disabled.

Passw. scheme:

Timeout: 180 s
 Scheme: DISABLED
 ECpanel
 Show passw: DISABLED



Password editing scheme setup page.

The password editing scheme can be enabled/disabled by the administrator.
 Level required for editing other settings, start/stop of plant etc. can be configured on dedicated permission setup pages.
 If password scheme is disabled, all users logged into web server will have administrator rights.
 Default passwords:
 Administrator: Password0.
 Service: Password1.
 Operator: Password2.
 The display of the ECpanel password in clear text on the ECpanel can be enabled.

2021-03-31-08:37:58

The password scheme holds four access levels:

1. Administrator.
2. Service.
3. Operator.
4. Viewer.

Required access levels of the various functionalities can be tailored by the customer as shown later. Whenever an attempt is made to alter/activate anything which is not allowed with the current access level, ECpv2 will discard the command and populate a message text informing which access level is required to apply the command.

Viewer level is obtained just by logging on to ECweb.

When to change the access level the upper right text string informing about the current access level is to be clicked. Doing that leads to the below log-in page.

User: ADMIN

Password: [masked]

Icons: Up arrow, Down arrow, Left arrow, Right arrow, Padlock

When logging in, the requested access level and associated password is typed in. When the correct password is typed in the padlock will open. Hereafter the log-in button must be clicked. That will give the selected access level and take you back to the previous page.

When logging out just click the log-out button. The ECpv2 will log out automatically when no editing occurs within the timeout period. Users will be degraded to Viewer level and must log in again as described above to regain the required access level.

When the password scheme is disabled as per default the user will have administrator rights.

Only an administrator can disable the password scheme.

Besides the enabling of the password scheme for ECweb itself, there is a setting for enabling visualization of the ECpanel password in clear text on the ECpanel itself. When disabled the ECpanel password is hidden on the ECpanel.

On the same submenu level the set up pages for Operator, Service and Administrator level passwords are found. Clicking the up/down arrows will lead to them.

Passwords

Operator access or higher is required for changing the Operator password.

Service access or higher is required for changing the Service password.

Administrator access is required for changing the Administrator password.

three dedicated menus exist for changing the passwords. Below is an example for changing Operator password.

ENcombi

ADMIN

Operator

Password: *****

Operator password setup page.
At least operator level login required
for changing operator password.

2020-07-10-13:23:09

On the same submenu level the set up pages for tailoring the access level required for executing various commands are found. Clicking the up/down arrows will lead to them.

Permissions

The various access levels required are set as the example below.

ENcombi

ADMIN

Log

Log setup:	SERVICE
Log deletes:	SERVICE
MySQL setup:	SERVICE
MySQL data:	SERVICE
MySQL deletes:	SERVICE

Settings

Settings:	SERVICE
Counters:	SERVICE
EClogic	ADMIN

Permissions setup page.
Setup password level required
for various actions.
Admin level login required for that.

2020-07-10-13:23:36

Only an administrator can change the access level required for the various functionalities.

License & Extras

Clicking the extras button leads to the page below where the list of available extras are displayed alongside which of them are present in the ECpv2. Activation of License as well as upgrading with new Extras are done from here.

The screenshot shows the ENcombi interface for license and extras management. At the top left is the ENcombi logo, and at the top right is an 'ADMIN' link. Below the logo, the word 'Extras:' is followed by a list of items, each with a yellow padlock icon and a description:

- A: Acquisition only
- C: Cloud service
- C TRIAL: Cloud service free trial
- H: Hybrid as a Service
- L: PV/genset plants, unlimitation PV capacity
- M: PV/genset plants, 500kW PV capacity limitation
- S: PV/genset plants, 100kW PV capacity limitation

In the center, a box contains the following text:

License and extras page.
 Contact dealer for purchase of license and extras.
 When purchased, the license or extras can be fetched
 by the device either online or from a USB stick.
 If online, the device must have access to the internet.
 If from USB stick, goto www.encombi.online to download license.

To the right of this box are two binoculars icons. The top one is labeled 'Search online:' and the bottom one is labeled 'Search on USB:'. In the top right corner, there is a red arrow icon pointing upwards.

At the bottom right of the page, the timestamp '2020-07-10-13:24:28' is displayed.

After purchase of License or any additional Extra(s) the ECpv2 is upgraded in one of the following ways.

Search online

The ECpv2 will have to be connected to the internet for this approach. Click the binoculars button for "Search online". When successfully completed, the ECpv2 will request a reboot.

Search on USB

The License and Extras for the specific ECpv2 are to be downloaded from ECcloud on www.encombi.online and put on the root directory on a USB stick. Insert the USB stick in the USB port on the ECpv2 and click the binoculars button for "Search on USB". The ECpv2 will check the USB stick for the upgrade. When successfully completed, the ECpv2 will request a reboot.

Metrics

Clicking the metrics button leads to the below page where the metrics to be used by ECpv2 can be set up. The ECpv2 will use the selected metrics for various displays on ECweb as well as in ECcloud.

Settings

Currency: Euro

Volume: liter

Mass: kg



Metrics setup page.
Selected units will be used for
various associated counters and derivatives.

Backups

Clicking the Backup button leads to the below page where the backups supported by ECpv2 are managed. The ECpv2 provides two backups.

1. Settings.
2. Counters.



Both types can be:

1. Generated and stored locally on internal memory of ECpv2.
2. Loaded into ECpv2 project from internal memory of ECpv2.
3. Copied from internal memory of ECpv2 to ENcombi cloud for safe storage.
4. Read from ENcombi cloud to internal memory of ECpv2.
5. Generated and stored on USB-stick.
6. Loaded into ECpv2 project from USB-stick.

When reading backups from the cloud it will overwrite any existing backup already present on the internal memory of the ECpv2. The presents of and date of origin of the backups on internal memory are displayed.

By default when reading backups from ENcombi cloud, the ECpv2 will read backups generated by itself. To clone an ECpv2 this can be done by typing in the MAC address of the ECpv2 you request to clone. Doing this ECpv2 will read backups generated by that ECpv2 instead.

ADMIN

Backup	Date	Action
Settings	2020-06-06-10:41:45	
Counters	N.A.	
MAC address:	0030569108A2	

Device backup page.
Following backups can be made:

- 1: Settings backup.
- 2: Counter backup.

The backups are saved and loaded locally on/from the device.
One backup for each function exist only.
Saving a new backup will overwrite any existing backup.

Backups can also be saved and read in/from cloud service.
One backup for each function per device can be saved only.
Reading a backup from cloud service,
will overwrite any existing local backup.

Furthermore backups can be saved on and loaded
from USB memory stick.

To clone a device, backups created from other devices
can be read from the cloud and loaded.
To do so, the MAC address of the device to clone from
must be typed in. The refresh button resets to the
MAC address of the device itself.

2020-07-10-13:25:29

Application

Clicking the Application button leads to the page below. Here it can be selected which application is to be active.

ENcombi ADMIN

Application

Application: ECPV

Application swap page.
Here it is set up which application to run.
When toggling between applications, the device is to be reboot. Any settings made in the ECPv application will be lost in the process. Store a backup before leaving the ECPv project if any settings are made that is to be restored when reverting to the ECPv application. Browser needs refreshing when the device has rebooted.

2020-07-25-20:29:32

The following applications are available.

1. ECpv2.
2. ECpv2 Service Tool.
3. ECpv2 Boot

ECpv2 is the default application and the one to use for the normal operation of the ECpv2. ECpv2 Service Tool is a separate application that offers various tests and configuration features and the ECpv2 Boot is a tool for updating both the ECpv2 and the ECpv2 Service Tool SW. The ECpv2 Service Tool and the ECpv2 Boot are treated in separate chapters.

When toggling between applications the device is to be rebooted. Any settings made in the ECpv2 application will be lost in the process. Make a backup before leaving the ECpv2 application if any settings are made that are to be restored when reverting to the ECpv2 application once again. The browser needs refreshing when the device is rebooted after switching the application.

Settings

Under this tile the setup of site specific parameters such as number and ratings of genset, grid connections, and inverters, which power meters are used, power and reactive control schemes etc. are found.

RS485 COM ports

The ECpv2 features two RS485 COM ports which are referred to as COM2 and COM3.

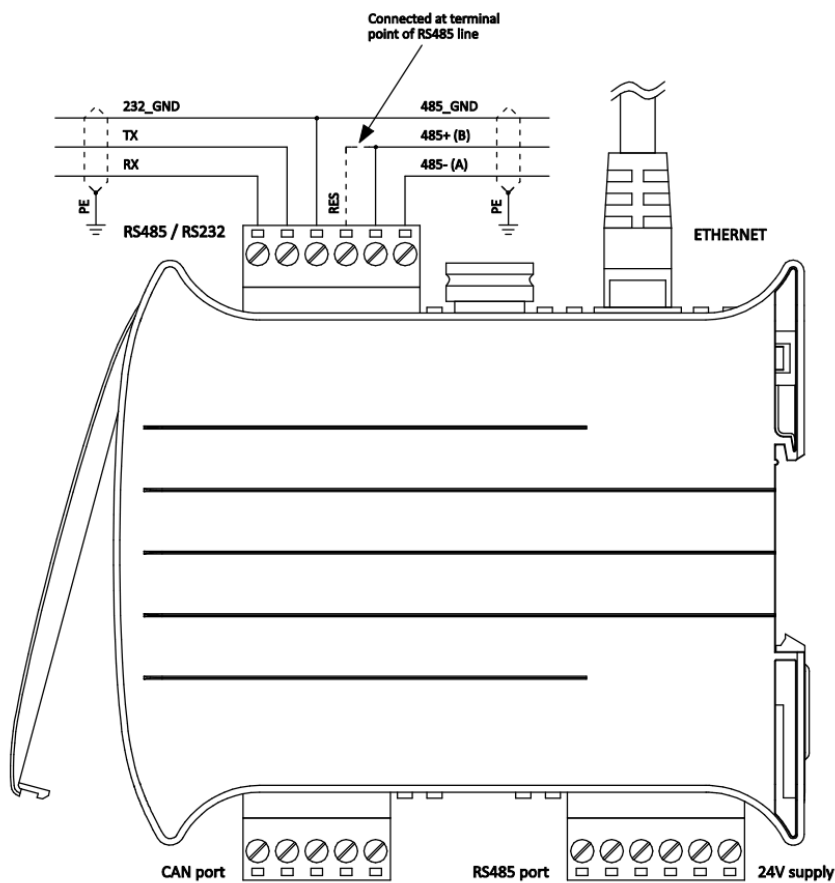

COM2 is the one found next to the power supply and COM3 is the one found next to the ethernet port.

- COM2 is reserved for interfacing to power meters and/or meteorological sensors.
In case none of this is enabled, COM2 is acting as a slave port.
- COM3 is reserved for interfacing to inverters and/or meteorological sensors.
In case none of this is enabled, COM3 is acting as a slave port.

First page presented when clicking the Settings tile is the below page where COM2 configuration is set up.

COM2 port

Baudrate:	19200
Parity:	NO PARITY 1 STOP BIT
Timeout:	0.3 s
TX rate:	1.0 s
Slave ID:	1



COM2 Port setup page.
Baudrates supported are 9600, 19200, 38400 and 115200.
Power meter RTU communication is fixed on COM2.
Sensor and IO module RTU communication is optional on COM2.
In case none of these communications are enabled, COM2 is serving as a Modbus RTU slave.
Slave ID is only used in case COM2 is serving as a slave.



2023-05-23-11:49:54

Baud rates supported are:

- 9600, 19200, 38400 and 115200

Parity supported are:

- "Parity one stop bit", "No parity", "Even parity" and "Odd parity".

When a COM2 port is acting as a master, the transmit rate can be used to control the rate at which the ECpv2 transmits to the slaves.

The Slave ID is only used when a COM2 port is acting as a slave.

On the same menu level a similar setup page for COM3 configuration is found. Clicking the up/down arrows will lead to it.

On the right hand side there are twelve submenus for.

1. PV related parameters.
2. Genset related parameters.
3. Mains related parameters.
4. Load parameter.
5. Sensor related parameters.
6. IO module related parameters.
7. Alarm related parameters.
8. Overview.
9. Night time.
10. Simulation.
11. Modbus slave profiles.
12. Monitoring parameters.

PV

Ratings

Clicking the PV button leads to the below page where the rated values of the PV installation are set up.

ENcombi ADMIN

Rated	
Inverter S:	20.0 kVA
Inverter Q:	20.0 kVA
Panel P:	20.0 kW

PV capacity setup page.
S and Q refers to installed inverter capacity.
P refers to installed PV panel capacity.

2021-03-28-14:04:03

Measurements

On the same submenu level the setup page for the sensing methods are found. Clicking the up/down arrows will lead to it.

ENcombi ADMIN

Measurement	
Sensing method:	SUM ALL PHASES
kW Origin:	PV METER
kWh Origin:	ECPV2

PV measurement setup page.
Sensing method determines if to base reference on the sum of all phases or 3 x sensing values.
AC origin determines from which source the PV production arises.
kWh origin determines from which source the genset energy production arises.

2022-09-27-20:22:05

Sensing method determines what power readings to base the calculated references upon. Two options are available.

1. Sum all phases.

2. 3 x sensing.

Sum all phases

The control will work on the total loading of all phases.

3 x sensing

Only one CT is installed, sensing the production in one phase only. The phase production measured is representative of the production on the other two phases. The ECpv2 will multiply the production sensed with three in order to get the total production.

kW origin determines from where to retrieve/calculate the PV power production.

Supported methods are:

1. PV meter.
2. Inverter acquisition.
3. Inverter master control.
4. Modbus page 03.
5. Mains Reading

PV meter

Up to 16 power meters for sensing PV production can be installed. ECpv2 will summarize the contributions from each of the meters into one common total for the PV power being produced. One meter is required for each cluster of inverters having a common point of coupling to the AC busbar.

Inverter acquisition

The ECpv2 can also take the power contribution of the individual inverters directly from their own power measurements via the inverter communication. This approach should be carefully considered as loop time of getting all the individual contributions increases with the number of inverters (when interfacing to them via Modbus RTU) thereby introducing latency in the controls.

Inverter master control

Some inverter systems have a superior controller sitting on top acting as the point of interface from a superior controller such as the ECpv2. Examples hereof can be the Inverter Manager from SMA or Smartlogger from Huawei. These master controllers typically offer a summarized production of all the below inverter contributions on their own which the ECpv2 can use directly. Again the loop time needs to be considered when using this method.

Modbus page 03

This will have ECpv2 use the PV power data written from a superior controller/SCADA to the ECpv2 proprietary modbus map page 3.

Mains Reading

In some cases the power reading from the Mains meter will always be equal and opposite of the PV meter reading. This is the case for example if no Load or gensets are connected and the PV plant is exclusively exporting power to the grid. When this setting is selected, the negative of the Mains meter reading will be used as the kW origin for the PV plant.

kWh origin determines from where to retrieve/calculate the PV energy production. Supported methods are:

1. ECpv2.
2. Power meters

ECpv2

Based on the kW measured, the ECpv2 integrates energy counters itself.

Power meters

The ECpv2 will read the total energy counter from the power meters and summarize those.

ECpv2 will, based on this, derive daily, monthly and yearly energy counters.

The meter used must provide either the total energy counter or the total energy export counter in order to make use of this approach. Consult the Modbus master documentation on ENcombi website for detailed information about what data is read from the various meter models.

<http://www.encombi.com/products/ECpv2/>

Note that all counters derived from energy counters remain linked to the ECpv2 energy counters still.

Reference

On the same submenu level the setup page for PV references are found. Clicking the up/down arrows will lead to it.

References

Priority:	OFF
Mains lim:	100.0 %
DG lim:	100.0 %
Cosphi cap:	0.600 C
Cosphi ind:	0.600 I
Cosphi lim:	DISABLED
Sensing method:	SUM ALL PHASES

Measurement

kW Origin:	PV METER
kWh Origin:	ECPV



PV reference setup page.
 Priority setting determines whether to prioritise P or Q reference over the other in case exceeding rated S inverter capacity.

Max dispatch limits can be set for parallel operation to both grid and gensets respectively. In case the reference is exceeding, the device will limit the P reference.

Cosphi cap and Cosphi ind outlines operating range of the inverters. In case enabled and reference exceeding, the device will limit the Q reference.

Sensing method determines if to base reference on the sum of all phases or 3 x sensing values.

AC origin determines from which source the PV production arises.

kWh origin determines from which source the genset energy production arises.



2021-03-28-14:05:03

Priority setting determines whether to prioritize P or Q reference over the other in case exceeding rated S inverter capacity.

Maximum power dispatch limits can be set for grid and genset operation respectively. In case the reference calculated by the control schemes exceeds the limits, then the reference will be truncated to the limits.

Cosphi cap and Cosphi ind outline the operating range of the inverters. If enabled and the reference exceeds the outlined range, the ECpv2 will limit the Q reference.

Ramp rates

On the same submenu level the setup page for PV ramp rates are found. Clicking the up/down arrows will lead to it.

Island

P ramp up:	2.0 %
P ramp down:	2.0 %
Q ramp up:	2.0 %
Q ramp down:	2.0 %

Grid-tied

P ramp up:	2.0 %
P ramp down:	2.0 %
Q ramp up:	2.0 %
Q ramp down:	2.0 %



PV ramp rate setup page.
 Ramp P and Ramp Q down determines the rate of change of the P and Q references respectively.
 In case PV paralleling with gensets only and these are in reverse power or overload state the ramps will be bypassed in order to attempt to clear the hazardous situation.



2021-03-28-14:13:12

Ramp P and Ramp Q down determine the rate of change of the P and Q references respectively. Unique ramp rates are available for Island and Grid-tied operations respectively. In case PV paralleling with gensets only and these are in reverse power or

overload state the ramps will be bypassed in order to attempt to clear the hazardous situation.

Ramp threshold

On the same submenu level, the setup page for Ramp threshold is found. Clicking the up/down arrows will lead to it. When starting the PV plant, the ECpv2 offers an initial ramp threshold to avoid the PV reference being ramped up before even connecting the inverters.

ENcombi ADMIN

Ramp thr.

P Target:	5.0 %
Ramp P Thr.:	1.0 %
Ramp Thr. del.:	10.0 s

PV ramp threshold setup page.
 The power reference will be kept at the target value.
 When the PV power exceeds the threshold value then the
 timer will start to run. When the time exceeds the threshold delay
 then the ramping is released.

2021-04-16-13:45:52

As long as the threshold delay is not elapsed, then the ECpv2 will use the threshold power target as the active power reference with a unity power factor for the PV plant. The threshold timer will start to run when the PV power production exceeds the Power threshold. Once the timer elapses, then the ramping is released and the PV reference will be ramped to the actual target references.

Tariff

On the same submenu level the setup page for PV Tariff is found. Clicking the up/down arrows will lead to it.

Tarif

Export: 0.02 Euro/kWh



PV tarif setup page.
The tarif for PV power produced.
Used by device for calculating PV export save.

2021-03-28-14:13:34

This tariff is for revenue generated based on the PV generation alone. This revenue is referred to as PV export save.

Counters

On the same submenu level pages for various PV related counters are found. Clicking the up/down arrows will lead to them.

- Produced energy (daily, monthly, yearly and total).
- Curtailed energy (daily, monthly, yearly and total).
- PV export save (daily, monthly, yearly and total).
- Mains import save (daily, monthly, yearly and total).
- Fuel save (daily, monthly, yearly and total).
- Fuel expense save (daily, monthly, yearly and total).
- CO2 emission save (daily, monthly, yearly and total).

Below is an example.

ENcombi ADMIN

Produced	Active	Update	
ACE:	0 kWh	<input type="text" value="0 kWh"/>	
ACE YEAR:	0 kWh	<input type="text" value="0 kWh"/>	
ACE MONTH:	0 kWh	<input type="text" value="0 kWh"/>	
ACE DAY:	0 kWh	<input type="text" value="0 kWh"/>	
Curtailed	Active	Update	
ACE:	0 kWh	<input type="text" value="0 kWh"/>	
ACE YEAR:	0 kWh	<input type="text" value="0 kWh"/>	
ACE MONTH:	0 kWh	<input type="text" value="0 kWh"/>	
ACE DAY:	0 kWh	<input type="text" value="0 kWh"/>	
Curtailment thrs.:	97.0 %	<input type="text" value="97.0 %"/>	

PV energy production counters preset page.
 Counters with checkmark in the update column will be preset with keyed in value when save button is pressed. Toggle between checkmark and crossmark by pressing the button.

 Curtailment threshold determines how close PV P production must be to the P reference before device interprets it as curtailment is ongoing. Curtailment state can only be set in case reference is below 100%.

2021-03-28-14:14:20

The counters will be incremented automatically by the ECpv2 in accordance with operation conditions. The counters are part of the counters backup discussed in the Identifier chapter.

The menus are only providing the possibility for manually presetting of the counters. Counters with a check mark in the update column will be preset with the keyed in value when the save button is pressed. Toggle between check mark and cross mark by pressing the respective buttons.

Curtailment threshold determines how close actual PV power production must be to the power reference before ECpv2 interprets it as curtailment is ongoing. Curtailment state can only be set in case reference is below 100%.

Meter

Clicking the power meter button on the right hand side of any of the above pages leads to the following page.

ENcombi

ADMIN

PV

Power meter: OFF

Modbus type: RTU

ID: 2

IP: 192.168.1.50

Sequential ID: DISABLED

Number: 1

TCP-RTU converter: DISABLED



PV power meter setup page.

A maximum of 16 power meters for PV is supported. The same make/model must be used for all gensect measurements. The communication can be either Modbus RTU or TCP.

In case of RTU then the Modbus IDs of the meters must be sequential with lowest ID being equal to the setting made in the device.

in case of TCP then the IP addresses of the meters must be sequential with lowest IP address being equal to the setting made in the device. When Sequential is disabled then the Modbus ID set is used for all the IPs. When Sequential is enabled then the Modbus ID set is used with the lowest IP and incremented together with the IP.

In case interfacing with Modbus TCP to Modbus RTU meters via a TCP-RTU converter, then this setting must be enabled. The IP address is then to be set equal to that of the converter and the modbus IDs are then used in the TCP frames from the ECpv2 to identify the individual meters.

Port settings is setup on dedicated port setup page.

2021-09-27-11:57:06

A maximum of 16 power meters for PV is supported. The same make/model must be used for all PV measurements. The communication can be either Modbus RTU or TCP. Check the link below to see which meters are supported by ECpv2.

<http://www.encombi.com/products/ECpv2/>

Should your preferred meter not be on the list already, contact ENcombi to request the adding of it.

In case of RTU then the Modbus IDs of the meters must be sequential with the lowest ID being equal to the setting made in the device.

In case of TCP then the IP addresses of the meters must be sequential with the lowest IP address being equal to the setting made in the device. When Sequential is disabled then the Modbus ID set is used for all the IPs. When Sequential is enabled then the Modbus ID set is used with the lowest IP and incremented together with the IP.

In case interfacing with Modbus TCP to Modbus RTU meters via a TCP-RTU converter, then this setting must be enabled. The IP address is then to be set equal to that of the converter and the modbus IDs are then used in the TCP frames from the ECpv2 to identify the individual meters.

Meter communication on Modbus RTU runs on the RS485 COM2 port as discussed earlier in this chapter.

Relay

On the same submenu level the page for setting up relay outputs on the power meters is found. Clicking the up/down arrows will lead to them.

ENcombi ADMIN

PV relay 1

Enable: DISABLED

Type: NO

PV relay 2

Enable: DISABLED

Type: NO

PV meter relay setup page.
The relay needs to be enabled with the intended functionality.
Furthermore normal state "open" or "closed" can be set.

2020-07-10-13:32:54

A total of two relay outputs can be controlled.

The relay needs to be enabled with the intended functionality.

1. Disabled
2. Alarm
3. EClogic

Furthermore the relay can be configured to be normally open or normally closed.

Relay control is not supported for all the power meters. Consult the Modbus Master documentation on ENcombi website to learn for which power meters the relay feature is supported:

<http://www.encombi.com/products/ECpv2/>

CT settings

On the same submenu level the page for setting up CT and VT settings for the power meters is found. Clicking the up/down arrows will lead to them. This feature applies for the Pilot SPM32 and SPM33 meters only. The Pilot meter CT and PT settings will by default automatically be read from the SPM32 and SPM33 power meters. If the CT and VT used on all PV meters are the same you can choose to type them in here and then have the ECpvX use those settings. This will speed up the loop time polling rate.

PV

CT1: 5 A

PT1: 22 times 10V

PT2: 220 V

Enable: DISABLED



PV meter CT and PT setup page.
 The Pilot meter CT and PT settings will per default automatically be read from the SPM32 and SPM33 power meters. If the CT and VT used on all PV clusters are the same you can choose to type them in here and then have the ECpX use those settings. This will speed up the loop time polling rate for the meters.

2023-08-31-09:58:12

Frame settings

On the same submenu level the frame setup is found. Modbus frames that only contain either energy counters or digital inputs can be disabled from this page. This will speed up the loop time polling rate for meters using separate KWH or DIGIN frames.

Frame:

KWH Frame: ENABLED

DIGIN Frame: ENABLED



PV meter frame setup page.
 Modbus frames containing only energy counters or digital inputs can be disabled individually. This will speed up the loop time polling rate for meters using separate KWH or DIGIN frames.

2024-04-16-14:37:23

Inverter

Clicking the inverter button leads to the following page.

ENcombi ADMIN

Inverter

Protocol:	OFF
Modbus type:	RTU
Control Fnc:	0x10
Control:	ENABLED
Data acquisition:	ENABLED
Number:	4

Inverter setup page.
 The device can interface to inverters via Modbus RTU or Modbus TCP. Besides controlling the inverters, the device can also do data acquisition. If data acquisition enabled, the device will read production data from all the inverters. The data read, will be visualized on dedicated page.

2020-07-10-13:33:20

A maximum of 32 inverters is supported by a single ECpv2. In case more than 32 inverters are to be controlled, multiple ECpv2 can be stacked to work together. This is discussed in a separate chapter later in this document. All inverters controlled by a single ECpv2 must be of the same vendor and possibly model. The communication can be either Modbus RTU or TCP.

Check the link below to see which inverters are supported by ECpv2.

<http://www.encombi.com/products/ECpv2/>

Should your preferred inverter not be on the list already, contact ENcombi to request the adding of it.

Controlling the inverters and data acquisition from the inverters can be enabled/disabled independently. ECpv2 supports Modbus function code 0x06 and 0x10 for applying control commands. Some inverters support only one of the two. Consult the Modbus Master documentation on ENcombi website to learn which function code to use with your inverter:

<http://www.encombi.com/products/ECpv2/>

If data acquisition is enabled, the data read from the inverters will be visualized on dedicated pages under monitoring.

RTU

On the same submenu level the page for setting up Modbus RTU specifics for inverter communication is found. Clicking the up/down arrows will lead to it.

RTU

Control type:	UNICAST
Initialization ID:	0
Broadcast ID:	0
Control ID:	1
Acquisition ID:	1



Inverter interface via Modbus RTU setup page.

The device can apply references as Unicast or as Broadcast. Unicast is applicable when interfacing to a single unit. This being a single inverter or a controller managing a pool of inverters. Broadcast is applicable for controlling a pool of inverters without the presents of a managing controller.

The modbus broadcast ID is configurable. Default and modbus standard is 0.

The Control ID is used for Unicast. If a managing controller is present the Control ID is to match that device. If no managing controller is present, the Control ID shall be set equal to the Acquisition ID.

The Identification ID used for protocol map identification routine.

The Acquisition ID shall be set equal to the lowest inverter ID present. When Acquisition enabled the device will read data from the inverters. The device will read from Acquisition ID an onwards, until the number of inverters selected is reached. The IDs of the inverters must be sequential.

2020-07-10-13:33:48

The ECpv2 can apply references as Unicast or as Broadcast. Unicast is applicable when interfacing to a single unit. This being a single inverter or a controller managing a pool of inverters. Broadcast is applicable for controlling a pool of inverters without the presence of a managing controller.

The Control ID is used for Unicast. If a managing controller is present, the Control ID is to match that device. If no managing controller is present, the Control ID shall be set equal to the Acquisition ID.

If the inverters do not support Broadcast, a pool of inverters can be controlled using Unicast still. In this case Control ID shall be set equal to the Acquisition ID.

The Initialization ID is used for any protocol initialization routine such as SunSpec map identification.

The Acquisition ID shall be set equal to the lowest inverter ID present. When Acquisition is enabled, the device will read data from the inverters. ECpv2 will read from Acquisition ID and onwards, until the number of inverters selected is reached. The IDs of the inverters must be sequential.

TCP

On the same submenu level the page for setting up Modbus TCP specifics for inverter communication is found. Clicking the up/down arrows will lead to it.

TCP

Control IP: 192.168.1.50

Acquisition IP: 192.168.1.50

TCP-RTU converter: DISABLED



Inverter interface via Modbus TCP setup page.

When controlling a pool of inverters, without the presents of a managing controller, the Control IP is to be set differently than the Acquisition IP. The RTU Initialization ID is in this case used for any initialization frames. The RTU Control ID is in this case used for all other frames. The IP addresses of the inverters must be sequential.

When controlling a single inverter or a pool of inverters with the presents of a managing controller, the Control IP is to be set equal to the Acquisition IP. The RTU Initialization ID is used for any initialization frames. The RTU Control ID is used for the control frames. The RTU Acquisition IDs are used for the data acquisition frames.

When controlling a single inverter or a pool of inverters via TCP-RTU converter, the Control IP is to be set equal to the Acquisition IP. The RTU Initialization ID is used for any initialization frames. The RTU Control IDs are used for the control frames. The RTU Acquisition IDs are used for the data acquisition frames.

2020-07-10-13:40:48

When controlling a pool of inverters, without the presence of a managing controller, the Control IP is to be set differently than the Acquisition IP.

- The RTU Initialization ID is used for all TCP frames related to protocol initialization routines such as the SunSpec map identification.
- The RTU ControlID is used for TCP frames for both acquisition and control references. The IP addresses of the inverters must be sequential.

When controlling a single inverter or a pool of inverters with the presence of a managing controller, the Control IP is to be set equal to the Acquisition IP.

- The RTU Initialization ID is used for all TCP frames related to protocol initialization routines such as the SunSpec map identification.
- The RTU Control ID is used for the TCP frames related to control references.
- The RTU Acquisition IDs are used for the TCP frames related to data acquisition.

Controlling a single inverter or a pool of inverters via a TCP/RTU converter can be useful sometimes if ECpv2 is to co-exist with a datalogger for instance. In this case the Control IP is to be set equal to the Acquisition IP.

- The RTU Initialization ID is used for all TCP frames related to protocol initialization routines such as the SunSpec map identification.
- The RTU Control ID is used for the TCP frames related to control references.
- The RTU Acquisition IDs are used for the TCP frames related to data acquisition.

This approach is not recommended with big inverter clusters as the Modbus TCP from ECpv2 will give references to the inverters individually. When passing this through a TCP/RTU converter the speed is limited to the serial line performance slowing this way down. For big clusters of inverters, going directly with Modbus RTU from ECpv2 via a serial line multiplexer is considered the best option as references can then be applied as broadcast commands.

Advanced Inverter command setup

On any of the above inverter pages, clicking the Command button will lead to the below page for advanced inverter command setup.

Common inverter command setup

ENcombi ADMIN

Inverter Cmd	
Interval:	300.0 s
P timeout:	60 s
Q timeout:	60 s

Common inverter command setup page.
 The delay between transmission of commands that is set to be transmitted at defined interval and reference fallback timeout values can be set here.
 Protocol specific command configuration is found on the following pages.

2020-07-10-13:41:08

These settings are common for all inverters and may or may not apply to the specific inverter make/model selected. Here the delay between transmission of commands that is set to be transmitted at a defined interval can be set. Furthermore, the fallback timeouts for reverting to a predefined production level in case of loss of communication can be set up.

SunSpec inverter command setup

Clicking the up/down button will lead to the SunSpec command setup page.

The screenshot shows the ENcombi web interface. On the left, there is a table for 'SunSpec Cmd' and 'SunSpec Acq' settings. In the center, there is a warning box with a pencil and up/down arrow icon. On the right, there is an 'ADMIN' link and a red up/down arrow icon.

SunSpec Cmd	
P enable:	CONTINUOUSLY
Q enable:	CONTINUOUSLY
P timeout:	DISABLE
Q timeout:	DISABLE
P scale:	AUTOMATIC
Q scale:	AUTOMATIC
SunSpec Acq	
I160:	ENABLED

SunSpec command setup page.
 The commands for enabling of P and Q references can be disabled, transmitted at defined interval or be transmitted continuously.
 The commands for timeout of P and Q references can be disabled, transmitted at defined interval or be transmitted continuously. The timeout values to sent are set up on the common inverter command page.
 The resolution used for power and reactive power references can be adjusted.

2020-11-18-12:07:05

For SunSpec protocol the commands for enabling P and Q references can be disabled, transmitted at a defined interval or be transmitted continuously. The same is the case for the transmission of the fallback timeout values.

The number of decimals used when applying the power and reactive power control commands can be adjusted. Default selection is "Automatic" as this is detected as part of SunSpec. However, in some cases it is found that the inverter vendors implementation is not according to the standard (due to old SW in the inverter or similar) and in those cases the automatics can be overruled and the number of decimals used can be fixed in accordance with the actual behavior of the inverter.

It can further be enabled/disabled whether to include the Multiple MPPT Extended Inverter Model (I160) as part of the inverter data acquisition.

Secondary inverter setup

Clicking the up/down button will lead to the Secondary inverter setup page.

Secondary inverter

Protocol:	OFF
Control Fnc:	0x10
Number:	1
Control:	DISABLED
Data acquisition:	DISABLED



Secondary inverter setup page.
The device can control a PV plant with a mix of up to two different inverter models.

On this page a secondary inverter model can be enabled. It is enabled by selecting a protocol and how many of the total number of inverters present that are of the secondary type.

On the primary inverter setup page inverter, the number of inverters to set must be the total number of inverters in the plant.

Secondary inverter support only applies for Non SunSpec protocols running on Modbus RTU and using Unicast command method.

The modbus IDs of all the inverters must be sequential with the primary inverters having the lowest IDs in the sequence.

2021-10-04-13:49:34

The ECpv2 can control a PV plant with a mix of up to two different inverter models. On this page a secondary inverter model can be enabled. It is enabled by selecting a protocol and how many of the total number of inverters present that are of the secondary type. On the primary inverter setup page inverter, the number of inverters to set must be the total number of inverters in the plant. Secondary inverter support only applies for Non SunSpec protocols running on Modbus RTU and using the Unicast command method. The modbus IDs of all the inverters must be sequential with the primary inverters having the lowest IDs in the sequence.

Multiple inverter cluster setup

Clicking the up/down button will lead to the pages for setting up multiple inverter clusters. An inverter cluster in this context is defined as one or more inverters being connected to a superior datalogger like a Huawei Smartlogger, a Sungrow COM100E or a SMA InverterManager. The ECpv2 can control up to 32 inverter clusters. Note that data acquisition of the individual inverters is limited to a maximum of 32 inverters. In the menu below it is set up how the total installed inverter capacity is split between the individual inverter clusters.

Cluster capacity

Cluster 1:	50.0 %
Cluster 2:	50.0 %
Cluster 3:	0.0 %
Cluster 4:	0.0 %
Cluster 5:	0.0 %
Cluster 6:	0.0 %
Cluster 7:	0.0 %
Cluster 8:	0.0 %



Inverter cluster setup page.
 The device can control a PV plant made up of multiple inverter clusters each being connected to a superior datalogger like the Huawei Smartlogger or the Sungrow COM100E.
 On this page the capacity of each of these clusters are to be set. It is set in in percentage of the total installed inverter capacity in the entire PV plant.

2022-06-28-11:59:10

In the menu below it is set up how many inverters are present in the individual clusters.

Cluster inverter nbr

Cluster 1:	4
Cluster 2:	6
Cluster 3:	0
Cluster 4:	0
Cluster 5:	0
Cluster 6:	0
Cluster 7:	0
Cluster 8:	0



Inverter cluster setup page.
 The device can control a PV plant made up of multiple inverter clusters each being connected to a superior datalogger like the Huawei Smartlogger or the Sungrow COM100E.
 On this page the number of inverters present in each of these clusters are to be set.

2022-06-28-12:00:38

The IP addresses of the superior dataloggers of the inverter cluster must come in a sequential order. Furthermore the Modbus IDs of the inverters in the individual clusters must be sequential and the Modbus ID sequence in each inverter cluster must start at the same value.

When making a multi cluster plant then the setting normally used for the number of inverters being present is instead referring to the number of inverter clusters (superior data loggers) being present.

Inverter PID control

On the same submenu level the page for configuring PID control of the Inverters can be found. Clicking the up/down arrows will lead to it.

P PID

Enable: DISABLED

Kp: 0.1

Ki: 0.025

Kd: 0.1

Q PID

Enable: DISABLED

Kp: 0.1

Ki: 0.025

Kd: 0.1



Inverter PID setup page.
 Per default the Inverter control is open loop.
 Here closed loop PID control can be enabled and adjusted.
 It can be selected whether to make the control using
 the active and reactive power adjustment control
 registers directly or indirectly via the voltage and frequency
 adjustment control registers instead.

2024-02-20-12:56:17

By default the PID control is disabled and the inverter control is open loop. Closed loop inverter control can help achieve the desired power output when controlling multiple inverters even if one or more of them are not producing the correct power. Active and reactive power closed loop control can be enabled separately.

Genset

Measurements

Clicking the Genset button leads to the page below where the sensing methods used when parallelling PV to utility are used.

The screenshot shows the ENcombi interface for Genset measurement setup. On the left, there is a table with the following settings:

Measurement	
Sensing method:	SUM ALL PHASES
GB Feedb. origin:	GENSET POWER
Threshold:	0.00 kW
kW Origin:	GENSET METER
kWh Origin:	ECPV2

In the center, there is a text box titled "Genset measurement setup page." containing the following text:

Sensing method determines if to base reference on the sum of all phases, 3 x lowest loaded phase or 3 x sensing values.
 GB feedback origin determines from which source the genset breaker position feedbacks arises.
 kWh origin determines from which source the genset energy production arises.

On the right side of the page, there is an "ADMIN" link and several navigation icons.

2022-09-27-20:18:44

Sensing method determines what power readings to base the calculated references upon. Three options are available.

1. Sum all phases.
2. 3 x lowest phase.
3. 3 x sensing.

Sum all phases

The control will work on the total loading of all phases not regarding any potential asymmetry. Using this method with asymmetrical loads and a low minimum genset load can result in a situation where the load on individual phase(s) gets very low with the risk of reversing.

3 x lowest phases

The control will identify the least loaded phase and multiply this by three. This can be useful when load is asymmetrical, avoiding the phenomenon described above. The net loading on the genset will be somewhat higher than the minimum genset load setting dictates but it will diminish the potential risk of feeding power into the genset(s) on the low loaded phase(s).

3 x sensing

This can be used when the load is symmetrical. Only one CT is installed, sensing the load from one phase only. The phase load measured is representative of the loading on the

other two phases. The ECpv2 will multiply the load sensed by three in order to get the total load.

GB feedback origin determines from which source the genset(s) breaker position closed feedback arises. Four options are available.

- Power meter / genset controller.
- Genset power.
- EClogic.
- Modbus page 03.

Power meter

In case a power meter is used instead of a direct interface to a genset controller, the input1 of the power meter will be interpreted as genset breaker closed feedback. When interfacing to a genset controller, the genset breaker closed feedback will already be wired to the genset controller and can in most cases be read directly by ECpv2.

Genset power

Whether a gensets breaker is closed can also be detected on the power reading itself. If a power is read from the power meter that exceeds the threshold, both positive and negative, the associated genset breaker is interpreted as being closed.

EClogic

In more complex electrical infra structures having for instance sectional breakers separating part of the gensets from the PV plant, a condition of whether the gensets are at all connected to the same AC busbar section as the PV needs to be taken into consideration. Such conditions can be customized from within EClogic.

Modbus page 03

This will have ECpv2 use the GB feedback data written from a superior controller/SCADA to the ECpv2 proprietary modbus map page 3.

kW origin determines from where to retrieve/calculate the genset power production. Supported methods are:

1. Genset meter.
2. Modbus page 03.

Genset meter

Up to 16 power meters for sensing Genset production can be installed. ECpv2 will summarize the contributions from each of the meters into one common total for the genset power being produced.

Modbus page 03

This will have ECpv2 use the genset power data written from a superior controller/SCADA to the ECpv2 proprietary modbus map page 3.

kWh origin determines from where to retrieve/calculate the genset energy production. Supported methods are:

1. ECpv2.
2. Power meters

ECpv2

Based on the kW measured, the ECpv2 integrates energy counters itself.

Power meters

The ECpv2 will read the total energy counter from the power meters and summarize those.

ECpv2 will, based on this, derive daily, monthly and yearly energy counters.

The meter used must provide either the total energy counter or the total energy export counter in order to make use of this approach. Consult the Modbus master documentation on ENcombi website for detailed information about what data is read from the various meter models.

<http://www.encombi.com/products/ECpv2/>

Note that all counters derived from energy counters remain linked to the ECpv2 energy counters still.

References

Clicking the up/down arrows leads to the page below where the reference used when paralleling PV to genset(s) are used.

ENcombi ADMIN

References	
Min. genset load:	30.0 %
Genset Q ctrl:	ALL Q
Cosphi cap:	0.800 C
Cosphi ind:	0.950 I

Genset reference setup page.
References applies for when running parallel to genset only.

The device will regulate PV power production in order to keep gensets connected running at the minimum genset load setting and the battery power to keep the genset at the uplimum load setting.

Genset Q ctrl determines the reactive power regulation.
All Q: Gensets carry all the reactive loading until limits reached.
Sharing Q: Same reactive loading on PV plant, battery and gensets.
Same cosphi: Same cosphi on PV plant, battery and gensets.
Fixed cosphi C DG: Fixed cap cosphi on the gensets.
Fixed cosphi I DG: Fixed ind cosphi on the gensets.
All Q no limits: Gensets carry all the reactive loading.

Cosphi cap and cosphi ind outlines the operating range of the gensets.
In case compromised, the PV and battery will pick up excessive reactive loading in order to keep gensets within their operating range.
This applies only for the selection "All Q" in Genset Q ctrl. setting.

2022-09-27-20:19:58

ECpv2 will regulate PV power production in order to keep gensets connected running at the minimum genset load setting.

Genset Q ctrl determines the reactive power regulation. Six options are available.

- All Q: the ECpv2 will let the gensets carry all the reactive loading until they reach the cosphi limits.
- Sharing Q: the ECpv2 will keep the same reactive loading on the PV plant and gensets.
- Same cosphi: the ECpv2 will keep the same cosphi on the PV plant and gensets.
- Fixed cosphi C DG: the ECpv2 will keep a fixed capacitive cosphi on the genset. The reference is determined by the "Cosphi cap" setting.
- Fixed cosphi I DG: the ECpv2 will keep a fixed inductive cosphi on the genset. The reference is determined by the "Cosphi ind" setting.
- All Q no limits: the ECpv2 will let the gensets carry all the reactive loading.

Cosphi cap and Cosphi ind outlines the operating range of the gensets. In case compromised the ECpv2 will pick up excessive reactive loading in order to keep gensets within their operating range. This applies only when "All Q" selection is made in Genset Q ctrl. setting.

Tariffs

On the same submenu level, the setup page for genset tariffs is found. Clicking the up/down arrows will lead to it.

Tarif

Efficiency:	0.25 liter/kWh
Price:	1.25 Euro/liter
Emission:	2.64 kg/liter



Genset tariff setup page.
Efficiency is used for calculating fuel volume consumed by the gensets as well as fuel volume saved by the PV plant.

Price is used for calculating fuel expense of the fuel volume consumed by the gensets as well as for the fuel expense spared by the PV plant.

Emission is used for calculating the CO2 emission generated fuel volume consumed by the gensets as well as for the CO2 emission spared by the PV plant.

2021-01-05-15:02:42

Efficiency is used for calculating fuel volume consumed by the gensets as well as fuel volume saved by the PV plant.





Price is used for calculating fuel expense of the fuel volume consumed by the gensets as well as for the fuel expense saved by the PV plant.

Emission is used for calculating the CO2 emission generated fuel volume consumed by the gensets as well as for the CO2 emission saved by the PV plant.

Rated sizes

On the same submenu level the setup pages for gensets rated power are found. Clicking the up/down arrows will lead to them.

ENcombi ADMIN

Rated			
Genset 1:	100.0 kW	  <div style="border: 1px solid black; padding: 5px; text-align: center; margin-top: 10px;">Genset capacity setup page.</div>	  
Genset 2:	100.0 kW		
Genset 3:	100.0 kW		
Genset 4:	100.0 kW		
Genset 5:	100.0 kW		
Genset 6:	100.0 kW		
Genset 7:	100.0 kW		
Genset 8:	100.0 kW		

2021-01-05-15:03:15

A total of 16 gensets are supported. Above page is one of two pages available for setting up the rated genset sizes.

Counters

On the same submenu level pages for various genset related counters are found. Clicking the up/down arrows will lead to them.

- Produced energy (daily, monthly, yearly and total).
- Fuel consumed (daily, monthly, yearly and total).
- Fuel expense (daily, monthly, yearly and total).
- CO2 emission (daily, monthly, yearly and total).

Below is an example.

ENcombi ADMIN

Produced	Active	Update	
ACE:	0 kWh	<input type="text" value="450 kWh"/>	<input checked="" type="checkbox"/>
ACE YEAR:	0 kWh	<input type="text" value="500 kWh"/>	<input checked="" type="checkbox"/>
ACE MONTH:	0 kWh	<input type="text" value="400 kWh"/>	<input checked="" type="checkbox"/>
ACE DAY:	0 kWh	<input type="text" value="410 kWh"/>	<input checked="" type="checkbox"/>
Fuel consumed	Active	Update	
Total:	0 liter	<input type="text" value="0.0"/>	<input checked="" type="checkbox"/>
Year:	0 liter	<input type="text" value="0.0"/>	<input checked="" type="checkbox"/>
Month:	0 liter	<input type="text" value="0.0"/>	<input checked="" type="checkbox"/>
Day:	0 liter	<input type="text" value="0.0"/>	<input checked="" type="checkbox"/>

Genset production counters preset page.
Counters with checkmark in the update column will be preset with keyed in value when save button is pressed. Toggle between checkmark and crossmark by pressing the button.

2021-01-05-15:11:48

The counters will be incremented automatically by the ECpv2 in accordance with operation conditions. The counters are part of the counters backup discussed in the Identifier chapter.

The menus are only providing the possibility for manually presetting of the counters. Counters with a check mark in the update column will be preset with the keyed in value when the save button is pressed. Toggle between check mark and cross mark by pressing the respective button.

Meter

Clicking the power meter button on the right hand side of any of the above pages leads to genset meter configuration. The genset meter configuration is done in the exact same manner as the already covered PV power meter configuration. Refer to PV power meter configuration for setting up of power meters.

Genset management

Clicking the genset management meter button on the right hand side of any of the above pages leads to the genset management configuration.

Load dependent start/stop

First page presented is the below page where Load depending start/stop scheme is configured.

LD start/stop

LD start:	80.0 %
LD start delay:	10.0 s
LD stop:	60.0 %
LD stop delay:	30.0 s
Start target:	100.0 kW
Spinning res.:	0.0 %
Enable:	DISABLED



Genset management setup page.

NON SYNC:
Load depending start/stop scheme for non-synch gensets. the device can do load depending start/stop handling of gensets.

The start/stop commands can in some cases be sent directly to the gensets via the communication to the genset controllers. Alternatively the start/stop commands can be linked to relay outputs via EClogic.

Load depending start/stop thresholds in percentage plus associated delays are available. The load depending start/stop thresholds are based on sum of genset load and PV spinning reserve contribution.

When genset start button is pushed initially the device will start suitable genset in accordance with the start target load.

Power measurement must be used for genset breaker position detection.

SYNC SR:
Spinning reserve scheme for synchronized gensets.
The actual load depending start/stop is in the scope of the genset control system. The device manipulates the PV output to provoke/prevent load depending start and stops in the genset system to secure a sufficient spinning reserve to withstand a loss of PV production.

2021-03-25-14:09:17

The ECpv2 can do load depending start- and stop handling of gensets for two types of genset systems.

1. Non-Sync.
Routine for non synchronizing gensets.
2. Sync SR.
Routine for synchronizing gensets with its own build in load depending start/stop scheme.

Non-sync.

This routine is for non-synch gensets. The ECpv2 will at all times only request for one genset to be connected and when swapping gensets it will make certain that one is disconnected before the next one is started and connected.

The start/stop commands can in some cases be sent directly to the gensets via the communication to the genset controllers. Consult the Modbus master documentation on ENcombi website to find out which supports this:

<http://www.encombi.com/products/ECpv2/>

Alternatively the start/stop commands can be linked to relay outputs via EClogic. Consult the Modbus slave documentation on ENcombi website for details on addresses to use:

<http://www.encombi.com/products/ECpv2/>

The load depending start threshold is compared to the sum of genset loads and the PV spinning reserve contribution. The PV spinning reserve contribution is a percentage of the actual load carried by the PV plant. When the condition is fulfilled for the selected load depending start delay, the ECpv2 will start a larger, more suitable genset for the load if available.

The load dependent stop threshold is compared to the sum of genset load and PV load. This is to make certain that when a smaller gensets is started to replace a bigger running genset that it will be able to carry the full load present which it will have to as PV production is temporarily lost when transitioning from the big to the small genset.

When genset management is enabled an additional start/stop button appears on the monitoring pages (see later) for starting and stopping of the genset plant. When the genset start button is pushed initially, the ECpv2 will start a suitable genset in accordance with the start target load. If the grid is connected the genset will lose the start signal and stop down. When the grid disconnects, the ECpv2 will use the start target to start a suitable genset.

“Genset Power” must be selected as the means for GB feedback detection.

Sync SR.

This routine is for synchronising gensets with its own build in load depending start/stop scheme.

The actual load depending start/stop is carried out by the genset control system but the ECpv2 will manipulate the loading on the gensets (via control of the PV production) to provoke/prevent load depending start and stops. The ECpv2 does so based on the Spinning reserve requested in the genset system. The PV spinning reserve request is the percentage setting set of the actual load carried by the PV plant.

To be able to withstand a complete loss of PV production at all times, the Spinning reserve should therefore be set to 100%. If the genset capacity needed (actual load plus the spinning reserve request) on the AC bus exceeds the load depending start threshold, then the ECpv2 will, after the load depending start delay expires, bring the genset up to that load depending start load by curtailing the PV. This will provoke a load depending start in the genset system bringing an additional genset online.

Similar, if the genset capacity needed (actual load plus the spinning reserve request) on the AC bus will exceed the load depending stop threshold after the potential stopping of a genset, then the ECpv2 will keep the gensets at the load depending stop threshold load to prevent the genset system from stopping down a genset.

Eventually if the load drops further and the genset capacity needed (actual load plus the spinning reserve request) on the AC bus will not exceed the load depending stop threshold after the potential stopping of a genset, then the ECpv2 will, after the load depending stop delay expires, bring the gensets to their minimum operating load which will result in the genset system stopping down a genset.

The genset system should be set up to do load depending start/stop calculations in percentage. It is recommended to set the load depending start/stop thresholds in the ECpv2 a few percentage higher than they are set in the genset system. If the gensets are

of different ratings, then the genset start priority should be set in the same order as the modbus ID meaning that the one with the lowest Modbus ID has first priority and so on.

Genset start/stop failures

On the same submenu level the setup page for genset start/stop failures are found. Clicking the up/down arrows will lead to it. This only applies for the Non-Sync routine only.

DG start fail.

Fail. delay: 30.0 s

Enable: DISABLED

Auto ack.: DISABLED



Genset start/stop failure setup page.

If genset start command is given and genset not on line within defined time a start failure is raised. That specific genset will not be considered available any longer until alarm is cleared. Manual alarm acknowledge will clear the alarm on all the gensets. Autoacknowledge will clear the alarm on all the gensets in case all gensets present are having start failure.

If genset stop command is given and genset not off line within defined time a stop failure is raised. In case stop failure is present all start commands are suppressed. All gensets must be off line before start command to new genset is given.

DG stop fail.

Fail. delay: 30.0 s

Enable: DISABLED

Auto ack.: DISABLED

If the genset start command is given and a genset is not on line within defined time a start failure is raised. That specific genset will not be considered available any longer until the alarm is cleared. Manual alarm acknowledgment will clear the alarm on all the gensets.

Auto acknowledge will clear the alarm on all the gensets in case all gensets present are having start failure.

If the genset stop command is given and the genset is not offline within defined time a stop failure is raised. In case stop failure is present all start commands are suppressed. All gensets must be offline before the ECpv2 sends the start command to a new genset.

Mains

Measurements

Clicking the mains button leads to the page below where the sensing methods used when parallelling PV to utility are used.

ENcombi ADMIN

Measurement

Sensing method:	SUM ALL PHASES
MB Feedb. origin:	FIXED ON
KW Origin:	MAINS METER
kWh Origin:	ECPV2

Mains measurement setup page.

Sensing method determines if to base reference on the sum of all phases,
3 x lowest loaded phase or 3 x sensing values.

MB feedback origin determines from which source
the mains breaker position feedbacks arises.

kWh origin determines from which source
the mains energy production arises.

2024-08-21-13:32:21

Sensing method determines what power readings to base the calculated references upon. Three options are available.

1. Sum all phases.
2. 3 x lowest phase.
3. 3 x sensing.

Sum all phases

The control will work on the total loading of all phases not regarding any potential asymmetry. Using this method with asymmetrical loads can in a self consumption situation for instance result in a situation where the net power feed to grid is in fact 0kW but there is import on some phase(s) and export on other phase(s).

3 x lowest phases

The control will identify the least loaded phase and multiply this with three. This can be useful when load is asymmetrical avoiding the situation described above. The net import power from the grid may not be 0kW but exporting power on any of the three phases is avoided.

3 x sensing

This can be used when load is symmetrical. Only one CT is installed, sensing the load from one phase only. The phase load sensed is representative for the loading on the

other two phases. The ECpv2 will multiply the load sensed with three in order to get the total load.

MB feedback origin determines from which source the mains breaker position closed feedbacks arises.

- Fixed on.
- Power meter.
- EClogic.
- All GB off
- Modbus page 03.

Fixed on

In case of sites without gensets where ECpv2 is used for self consumption operation alone for example, the mains breaker position can always be assumed to be closed.

Power meter

In case a power meter is used the input1 of the power meter will be interpreted as mains breaker closed feedback.

EClogic

In more complex electrical infra structures having for instance sectional breakers separating the utility from the PV plant, a condition of whether the utility is at all connected to the same AC busbar section as the PV needs to be taken into consideration. Such conditions can be customized from within EClogic.

All GB off

In case all GBs are off and there is no genset communication alarm present, the ECpv2 will interpret this as the mains breaker position is closed.

Modbus page 03

This will have ECpv2 use the MB feedback data written from a superior controller/SCADA to the ECpv2 proprietary modbus map page 3.

kW origin determines from where to retrieve/calculate the grid power production. Supported methods are:

1. Mains meter.
2. Modbus page 03.
3. PV Comm.

Mains meter

Up to 16 power meters for sensing grid production can be installed. ECpv2 will summarize the contributions from each of the meters into one common total for the grid power being imported/exported.

Modbus page 03

This will have ECpv2 use the grid power data written from a superior controller/SCADA to the ECpv2 proprietary modbus map page 3.

PV Comm.

Some vendors' inverters / inverter managers support data acquisition from a power meter installed at the grid connection. The ECpv2 will acquire the active and reactive power readings from this meter via the PV communication.

kWh origin determines from where to retrieve/calculate the grid energy imported and exported. Supported methods are:

1. ECpv2.
2. Power meters

ECpv2

Based on the kW measured, the ECpv2 integrates energy counters itself.

Power meters

The ECpv2 will read the total energy counter from the power meters and summarize those.

ECpv2 will, based on this, derive daily, monthly and yearly energy counters.

The meter used must provide both the total energy export counter and the total energy import counter in order to make use of this approach. Consult the Modbus master documentation on ENcombi website for detailed information about what data is read from the various meter models.

<http://www.encombi.com/products/ECpv2/>

Note that all counters derived from energy counters remain linked to the ECpv2 energy counters still.

References

On the same submenu level the setup page for References is found. Clicking the up/down arrows will lead to it.

References

Mains P ctrl:	FIXED P
PREF:	20.0 kW
Mains Q ctrl:	FIXED Q
QREF:	0.0 kVAr
COSPHIREF:	1.000



Mains reference setup page.
References applies for PV when running parallel to utility.

Mains P ctrl determines the active power regulation scheme.
Fixed P: the device will keep the active PV power production fixed.
Fixed P PCC: device will keep the active power production fixed at point of connection to utility.
 PREF is used as reference by the Mains P ctrl scheme.

Mains Q ctrl determines the reactive power regulation scheme.
Fixed Q: the device will keep the reactive PV power production fixed.
Fixed Q PCC: device will keep the reactive power production fixed at point of connection to utility.
Fixed cosphi C or Fixed cosphi I: the device will keep the cosphi of the PV plant fixed running capacitive and inductive respectively.
Fixed cosphi C PCC or Fixed cosphi I PCC: the device will keep the cosphi at point of connection to utility fixed, capacitive and inductive respectively.
 QREF and COSPHIREF are used as references by the Mains Q ctrl scheme.

2024-08-21-13:32:46

Mains P ctrl determines the active power regulation scheme.

- Fixed P: the device will keep the active PV power production fixed.
- Fixed P PCC: device will keep the active power production fixed at the point of connection to utility. This is therefore to be the selected method for doing self consumption / zero export operation.

PREF is used as the reference setting by the Mains P ctrl scheme.

Mains Q ctrl determines the reactive power regulation scheme.

- Fixed Q: the device will keep the reactive PV power production fixed.
- Fixed Q PCC: device will keep the reactive power production fixed at the point of connection to utility.
- Fixed cosphi C or Fixed cosphi I: the device will keep the cosphi of the PV plant fixed running capacitive and inductive respectively.
- Fixed cosphi C PCC or Fixed cosphi I PCC: the device will keep the cosphi at point of connection to utility fixed, capacitive and inductive respectively.
- Same cosphi: the device will keep the same cosphi on the PV plant and utility.

QREF and COSPHIREF are used as reference settings by the Mains Q ctrl scheme.

API

On the same submenu level the setup page for API setup is found. Clicking the up/down arrows will lead to it.

The ECpv2 can take in various commands including power and reactive power commands for PV via ECapi. This enables an online optimizer service provider to control the PV via ECapi thereby eliminating the need for installing any additional HW on site. The API setting must be enabled in order to have the ECpv2 accepting commands applied via ECapi. Consult the ECapi documentation on which commands are available and how to apply them.

Tariffs

On the same submenu level the setup page for utility tariffs are found. Clicking the up/down arrows will lead to it.

Import is used for calculating expense for the energy imported by the utility as well as for the import savings generated by the PV plant.

Export is used for calculating earnings for the energy exported to the utility.

Emission is used for calculating the CO2 emission savings due to the PV power produced while parallel to the grid.

For some European markets the tariffs can be based on the hourly market spot prices. The spot price will apply for both import and export tariffs. Pick the relevant market and enable the spot price to activate it. The spot price market works in Euro and the exchange rate between Euro and the local currency must be keyed in separately.

Rated sizes

On the same submenu level the setup pages for gensets rated power are found. Clicking the up/down arrows will lead to them.

ENcombi

ADMIN

Rated	
Mains 1:	100.0 kW
Mains 2:	100.0 kW
Mains 3:	100.0 kW
Mains 4:	100.0 kW
Mains 5:	100.0 kW
Mains 6:	100.0 kW
Mains 7:	100.0 kW
Mains 8:	100.0 kW

Mains capacity setup page.

2024-08-21-13:29:50



A total of 16 utility connections are supported. Above page is one of two pages available for setting up the rated mains trafo sizes.

Counters



On the same submenu level pages for various utility related counters are found. Clicking the up/down arrows will lead to them.

- Imported energy (daily, monthly, yearly and total).
- Exported energy (daily, monthly, yearly and total).
- Import expense (daily, monthly, yearly and total).
- Export revenue (daily, monthly, yearly and total).

Below is an example.

Imported	Active	Update	
ACE:	0 kWh	<input type="text" value="0 kWh"/>	<input checked="" type="checkbox"/>  
ACE YEAR:	0 kWh	<input type="text" value="0 kWh"/>	<input checked="" type="checkbox"/>
ACE MONTH:	0 kWh	<input type="text" value="0 kWh"/>	<input checked="" type="checkbox"/>
ACE DAY:	0 kWh	<input type="text" value="0 kWh"/>	<input checked="" type="checkbox"/>
Exported	Active	Update	
ACE:	0 kWh	<input type="text" value="0 kWh"/>	<input checked="" type="checkbox"/>
ACE YEAR:	0 kWh	<input type="text" value="0 kWh"/>	<input checked="" type="checkbox"/>
ACE MONTH:	0 kWh	<input type="text" value="0 kWh"/>	<input checked="" type="checkbox"/>
ACE DAY:	0 kWh	<input type="text" value="0 kWh"/>	<input checked="" type="checkbox"/>

Mains import/export counters preset page.
 Counters with checkmark in the update column will be preset with keyed in value when save button is pressed.
 Toggle between checkmark and crossmark by pressing the button.

2024-08-21-13:30:33

The counters will be incremented automatically by the ECpv2 in accordance with operation conditions. The counters are part of the counters backup discussed in the Identifier chapter.

The menus are only providing the possibility for manually presetting of the counters. Counters with a check mark in the update column will be preset with the keyed in value when the save button is pressed. Toggle between check mark and cross mark by pressing the respective button.

Meter

Clicking the power meter button on the right hand side of any of the above pages leads to mains meter configuration. The mains meter configuration is done in the exact same manner as the already covered PV power meter configuration. Refer to PV power meter configuration for setting up of power meters.

Grid support

Clicking the grid support button on the right hand side of any of the above pages leads to grid support configuration.

Grid support P(f)

On the same submenu level the setup page for frequency support is found. Clicking the up/down arrows will lead to it.

ENcombi

ADMIN

Grid support P(f)

Deadband low:	49.00 Hz
Slope low:	10.00 kW/Hz
Cutoff low:	48.00 Hz
Deadband high:	51.00 Hz
Slope high:	-10.00 kW/Hz
Cutoff high:	52.00 Hz
Enable:	DISABLED



P(f) grid support setup page.
 When grid frequency is within defined deadband the power reference is unaffected by the grid support.
 When frequency goes above or below the deadband the reference is set equal to the PV power at that instance. The reference is then altered according to the frequency and the respective slopes. Frequencies above or below cutoff thresholds do not contribute to further alteration.
 Once frequency returns within the defined deadband, the references are again passed by without interference from the grid support.

2024-08-21-13:31:19

When the grid frequency is within the defined deadband the power reference is unaffected by the grid support. When frequency goes above or below the deadband the reference is set equal to the PV power at that instance. The reference is then altered according to the frequency and the respective slopes. Frequencies above or below cutoff thresholds do not contribute to further alteration.

Once frequency returns within the defined deadband, the references are again passed by without interference from the grid support. Note that when grid power origin is set to "Mains meter" the Line1 frequency needs to be part of the data read from the mains meter in order to use the frequency support. Consult the Modbus master documentation on ENcombi website for detailed information about what data is read from the various meter models.

<http://www.encombi.com/products/ECpv2/>

Grid support U(Q)

On the same submenu level the setup page for frequency support is found. Clicking the up/down arrows will lead to it.

ENcombi

ADMIN

Grid support Q(U)

Deadband low:	390.0 V
Slope low:	10.00 kVar/V
Cutoff low:	380.0 V
Deadband high:	410.0 V
Slope high:	-10.00 kVar/V
Cutoff high:	420.0 V
Enable:	DISABLED



Q(U) grid support setup page.
 When grid voltage is within defined deadband the reactive power reference is unaffected by the grid support.
 When voltage goes above or below the deadband the reference is set equal to the PV reactive power at that instance.
 The reference is then altered according to the voltage and the respective slopes. Voltages above or below cutoff thresholds do not contribute to further alteration.
 Once voltage returns within the defined deadband, the references are again passed by without interference from the grid support.

2024-08-21-13:31:41

When the grid voltage is within a defined deadband the reactive power reference is unaffected by the grid support. When voltage goes above or below the deadband then the reference is set equal to the PV reactive power at that instance. The reference is then altered according to the voltage and the respective slopes. Voltages above or below cutoff thresholds do not contribute to further alteration.

Once voltage returns within the defined deadband, the references are again passed by without interference from the grid support. Note that when grid power origin is set to "Mains meter" that Line1-Line2 voltage needs to be part of the data read from the mains meter in order to use the voltage support. Consult the Modbus master documentation on ENcombi website for detailed information about what data is read from the various meter models.

<http://www.encombi.com/products/ECpv2/>

Load

Clicking the Load button leads to the following page.

ENcombi ADMIN

Load power meter

DG load meter: 0

PV load meter: 0

Mains load meter: 0

Load power meter setup page.
 A maximum of 48 power meters for load is supported.
 Load meters are divided into three groups,
 each with a maximum of 16 meters.
 The three groups share the protocol and ID range with the
 source meters for PV, DG and Mains respectively.
 Group1 shares with DG, Group2 shares with PV and Group3 shares with Mains.
 The number of load meter plus the number of source meters for each group
 can be a maximum of 16 meters.

2022-04-06-10:25:25

Above page there are 3 options to select load power meters. If the DG load meter is selected, the power meter protocol is selected on the DG power meter page. The ID of the load meter will be the next ID after the DG power meter.

If selecting PV or mains load meter, it is the same philosophy. The protocol is selected on the DG, PV or mains power meter setup page.

Example with the same power meter model:

2 x DG power meters with ID 3 and 4.

1 x load power meter with ID 5.

Under the DG power meter setup page the specific power meter protocol is selected and ID 3 is set as ID and the number of power meters is set to 2.

Then the user needs to select 1 load power meter in the DG load meter setting. Then the user is able to see data from all 3 power meters; the first 2 power meters are from DG and the third is from the load meter.

Example with different power meter models:

2 x DG power meters with ID 3 and 4.

1 x load power meter with ID 5.

Under the DG power meter setup page the specific power meter protocol is selected and ID 3 is set as ID and the number of power meters is set to 2.

The load power meter is another protocol than the DG power meter protocol, so the user will need to configure a PV power meter with the correct protocol. On the setup page the user will type in 0 as the number of PV power meters and the ID must be the load power meter ID, which is 5.

Then go to the load power meter setup page and select 1 meter for the PV load power meter setting.

Load meter for control

Clicking the Advanced button to the right hand side will lead to the menu below.

ENcombi ADMIN

Load power meter

DG calc.	DISABLED
Grid calc.	DISABLED

Load meter control setup page.
 Per default the system measures the production of the sources, calculates the total load consumption based and bases its control on that. It is possible to do the opposite and have the system use the load meter readings instead to calculate the source power.
 If for instance the load is measured instead of the power at the grid connection point then when the system is connected to grid the power at the grid connection point can be calculated.

2022-04-06-10:30:09

Normally the total load in the system is a calculated value based on the production of the various sources (genset, PV and grid) and the control is based on the readings from the sources directly. On this page it is possible to have the ECpv2 use the readings from the load meters as an expression of the total loading in the system and use this for calculating the power flowing in/out of the grid when being parallel to the grid and the power production of the genset when being parallel to the genset respectively and do its control based upon that instead.

This can be useful in the various cases where for instance the grid meters can't be mounted due to physical constraints and only load meters are available or it could be a simple ATS application with one genset and one grid, then the control can be base on a single meter placed on the load side of the ATS instead of having both a power meter for the genset and a power meter for the grid.

Sensors

Clicking the sensor button leads to the following page.

ENcombi ADMIN

Sensors

POA origin:	OFF
BOM origin:	OFF
GHI origin:	OFF
Amb. temp. origin:	OFF
Wind speed origin:	OFF
RH origin:	OFF
Bar. press. origin:	OFF
Wind dir. origin:	OFF
Rain origin:	OFF

2020-07-10-13:41:50

Above page holds the list of all meteorological readings supported. The origin of these readings can be selected as either Modbus RTU based sensors, inverter communication or by Modbus page 3.

Modbus RTU Sensors

On the same submenu level the page for setting up Modbus RTU sensor communication is found. Clicking the up/down arrows will lead to it.

ENcombi ADMIN

Sensors

COM port:	COM2
Sensor 1:	OFF
Sensor 1 ID:	1
Sensor 2:	OFF
Sensor 2 ID:	1
Sensor 3:	OFF
Sensor 3 ID:	1
Sensor 4:	OFF
Sensor 4 ID:	1

2020-07-10-13:42:10

Sensor communication is running on Modbus RTU only. Whether to use sensors on COM2 or COM3 is selectable by parameter. A maximum of 4 Modbus RTU sensors can be connected to the ECpv2.

Check the link below to see which sensors are supported by ECpv2.

<http://www.encombi.com/products/ECpv2/>

PV generating capacity

On the same submenu level the page for calculating the generating capacity (GC) of the PV panels is found. Clicking the up/down arrows will lead to it.

ENcombi

ADMIN

Sensors

Panel temp. coef.:	-0.41 %/C
Degradation:	0.0 %/year
Year:	2022
DC loss:	0.0 %
Inv. efficiency:	100.0 %
AC loss:	0.0 %
BOM Offset:	0.0 C
GC compensation:	OFF



PV generating capacity setup page.
 Panel temperature coefficient can be keyed in.
 Based on POA and BOM, generating capacity compensation of the PV panels installed can be calculated. Furthermore can the panel degradation factor, DC loss factor, inverter efficiency and AC loss factor be keyed in to get the generating capacity on the AC side.
 The device uses the the generating capacity on the AC side for handling curtailment counters and PV performance ratios. In case generating capacity compensation is not enabled, installed PV panel capacity will be used as PV generating capacity by device.

2022-09-27-20:09:49

GC compensation selection determines if and how to perform generating capacity compensation for the PV panels. The ECpv2 uses PV panel generating capacity for handling curtailment counters and PV performance ratios. Supported methods are:

1. Disabled.
2. Sensors.
3. Modbus page 03.

Disabled

In this case the installed PV panel capacity will be used as PV generating capacity by the ECpv2.

Sensors

Based on the keyed-in Installed PV panel capacity, the PV panel temperature coefficient, The PV panel degradation, DC losses, inverter efficiency, AC losses and the readings from the POA and BOM sensors, the generating capacity of the PV panels is calculated. The efficiency of the inverters is thereafter included to get the PV generating capacity.

Modbus page 03



This will have ECpv2 use the PV generating capacity data written from a superior controller/SCADA to the ECpv2 proprietary modbus map page 3.

IO modules

Clicking the IO module button leads to the following page.

ENcombi VIEWER

IO modules	
COM port:	COM2
IO 1:	OFF
IO 2:	OFF
IO 3:	OFF
IO 4:	OFF

IO module setup page.
 IO module communication can either run Modbus RTU or Modbus TCP.
 Whether to use COM2, COM3 or TCP is selectable by parameter.
 Port settings is setup at dedicated port setup page.



2021-01-22-17:11:09

Above page holds the setting up Modbus IO module communication. IO module communication runs either Modbus RTU or Modbus TCP. Whether to use IO modules on COM2, COM3 or TCP is selectable by parameter. A maximum of 4 Modbus IO modules can be connected to the ECpv2. The ECpv2 can also read IO data directly from another ECpv2. This is selectable by parameter.



Check the link below to see which IO modules are supported by ECpv2.

<http://www.encombi.com/products/ECpv2/>

Clicking the up/down arrows leads to the page below where the Modbus ID and IP addresses for the respective IO modules are set up.

ENcombi ADMIN

IO modules	
IO 1 ID:	1
IO 1 IP:	192.168.1.50
IO 2 ID:	1
IO 2 IP:	192.168.1.50
IO 3 ID:	1
IO 3 IP:	192.168.1.50
IO 4 ID:	1
IO 4 IP:	192.168.1.50

IO module setup page.
 Modbus RTU ID of the IO modules is selectable by parameter.
 Modbus TCP IP of the IO modules is selectable by parameter.
 The Modbus ID selected is used in the TCP frames.



2021-01-24-11:56:05

Analogue input/output

When an analogue module is selected in the IO window setup, all the related settings are placed in the monitoring of the IO module.

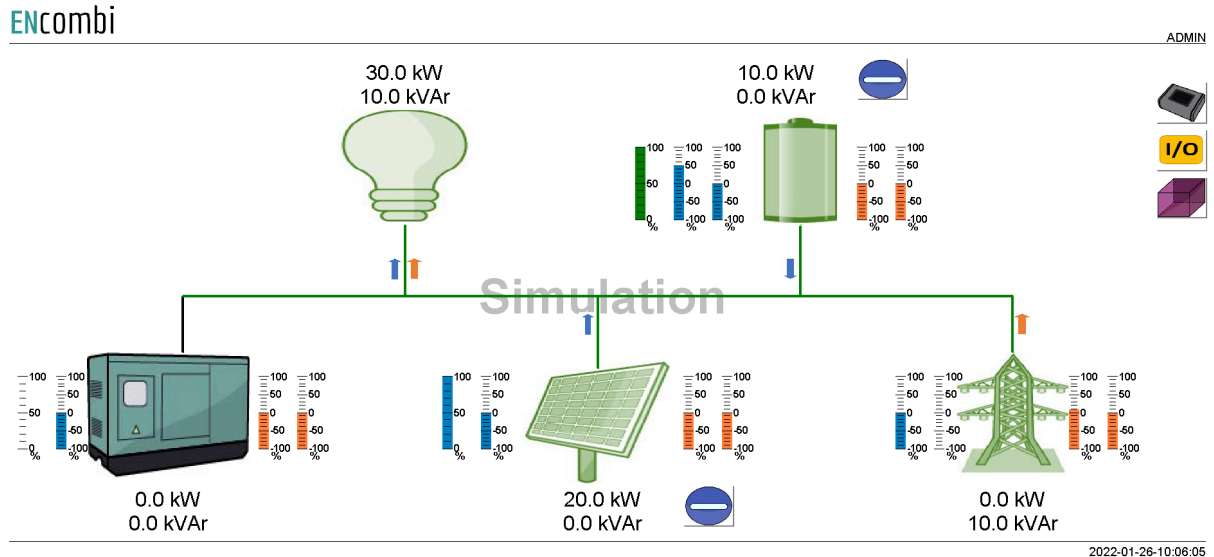

When pressing the IO button to the right, it will lead to the following page.

The IO modules configuration table is as follows:

IO modules	IO type	IO inputs	IO outputs	Communication state:	Communication enable:
IO 1:	EX04AIO	N.A	N.A		
IO 2:	EX04AIO	N.A	N.A		
IO 3:	EX1608DD	0011 0000 0000 1100	0000 0000 0000 0000		
IO 4:	EX04AIS	N.A	N.A		

ADMIN 2022-02-01-09:20:08

From this page it is possible to select which IO module to set up and monitor values. If the IO module is digital input/output, it is not possible to click on the module, the actual bit value is present at this page.

By clicking on the IOx module, it will lead to the following page.

IO2	AIO type	Value	PCT	Minimum Scale	Maximum Scale	State:
Channel 1:	INPUT	1500.0	36.6 %	0.0	4095.0	Normal
Channel 2:	INPUT	2000.0	48.8 %	0.0	4095.0	Normal
Channel 3:	OUTPUT	0.0	0.0 %	0.0	4095.0	Normal
Channel 4:	OFF	N.A	N.A	0.0	4095.0	N.A



Module temp: 32.2 C

Communication state:

2022-02-07-14:16:54

From this page it is possible to scale the input/output on each channel of the IO module. The input value can be used for Pref, Qref or other data points. This is set in EClogic. The value shown is the scaled value and the percentage is the percentage of the range from 0-100%. The maximum range is 0-4095. The module temperature is shown in the lower right corner and the state of each channel can be read to the right.

Alarms

Clicking the alarm button leads to menus of customizable alarms.

- Genset low power.
- Mains low power.
- COM2 port slave alarm.
- COM3 port slave alarm.
- TCP port slave alarm.
- Fuel level alarm.
- Common Master communication.

Other alarms exist as well but they are not customizable alarms as the ones listed above.

Genset low power

ENcombi

ADMIN

DG low P

Threshold:	-5 %
Delay:	5.0 s
Enable:	DISABLED
Signal:	DISABLED
Action:	NOTIFICATION
Auto ack.:	DISABLED



Genset low power alarm setup page.
 When genset power is below the threshold the alarm condition is present.
 When condition has been present for a periode equal to or longer than the delay and in case the alarm is enabled the alarm is provoked.
 When alarm is provoked, the signal selected will be activated and the action selected will be taken.
 The alarm is automatically acknowledged in case auto ack. is enabled.

2020-07-10-13:49:26

When the genset power is below the threshold, the alarm condition is present. When the condition has been present for a period equal to or longer than the delay and in case the alarm is enabled, the alarm is provoked. When the alarm is provoked, the signal selected will be activated and the action selected will be taken. The alarm is automatically acknowledged in case auto ack. is enabled.

Signals available:

1. Relay01 on all PV meters
2. Relay02 on all PV meters
3. Relay01 on all genset meters
4. Relay02 on all genset meters
5. Relay01 on all mains meters
6. Relay02 on all mains meters

If to activate a relay on a specific meter only, then this can be made through EClogic.

Actions available:

1. Notification
2. Soft stop
3. Hard stop

Notification means populating an alarm and creating a log entry.

Soft stop and Hard stop will besides the notification also stop the PV plant. That being with power ramp down and without power ramp down respectively.

Mains low power

ENcombi

ADMIN

Mains low P

Threshold:	-5 %
Delay:	5.0 s
Enable:	DISABLED
Signal:	DISABLED
Action:	NOTIFICATION
Auto ack.:	DISABLED



Mains low power alarm setup page.
 When mains power is below the threshold the alarm condition is present.
 When condition has been present for a periode equal to or longer than the delay and in case the alarm is enabled the alarm is provoked.
 When alarm is provoked, the signal selected will be activated and the action selected will be taken.
 The alarm is automatically acknowledged in case auto ack. is enabled.

2020-07-10-13:49:45

When the mains power is below the threshold the alarm condition is present. When the condition has been present for a period equal to or longer than the delay and in case the alarm is enabled, the alarm is provoked. When the alarm is provoked, the signal selected will be activated and the action selected will be taken. The alarm is automatically acknowledged in case auto ack. is enabled.

COM2 slave

ENcombi

ADMIN

COM2 slave

Delay:	5.0 s
Enable:	DISABLED
Signal:	DISABLED
Action:	NOTIFICATION
Auto ack.:	DISABLED



COM2 slave alarm setup page.
 When no frames are received from modbus master the alarm condition is present.
 When condition has been present for a periode equal to or longer than the delay and in case the alarm is enabled, the alarm is provoked.
 When alarm is provoked, the signal selected will be activated and the action selected will be taken.
 The alarm is automatically acknowledged in case auto ack. is enabled.

2020-07-10-13:50:04

When no frames are received from the modbus master, the alarm condition is present. When the condition has been present for a period equal to or longer than the delay and in case the alarm is enabled, the alarm is provoked. When the alarm is provoked, the signal selected will be activated and the action selected will be taken. The alarm is automatically acknowledged in case auto ack. is enabled.

COM3 slave

ENcombi

ADMIN

COM3 slave

Delay:	5.0 s
Enable:	DISABLED
Signal:	DISABLED
Action:	NOTIFICATION
Auto ack.:	DISABLED



COM3 slave alarm setup page.
 When no frames are received from modbus master the alarm condition is present.
 When condition has been present for a periode equal to or longer than the delay and in case the alarm is enabled, the alarm is provoked.
 When alarm is provoked, the signal selected will be activated and the action selected will be taken.
 The alarm is automatically acknowledged in case auto ack. is enabled.

2020-07-10-13:50:21

When no frames are received from the modbus master, the alarm condition is present. When the condition has been present for a period equal to or longer than the delay and in case the alarm is enabled, the alarm is provoked. When the alarm is provoked, the signal selected will be activated and the action selected will be taken. The alarm is automatically acknowledged in case auto ack. is enabled.

TCP slave

ENcombi

ADMIN

TCP slave

Delay:	5.0 s
Enable:	DISABLED
Signal:	DISABLED
Action:	NOTIFICATION
Auto ack.:	DISABLED



TCP slave alarm setup page.
 When no frames are received from modbus master the alarm condition is present.
 When condition has been present for a periode equal to or longer than the delay and in case the alarm is enabled, the alarm is provoked.
 When alarm is provoked, the signal selected will be activated and the action selected will be taken.
 The alarm is automatically acknowledged in case auto ack. is enabled.

2020-07-10-13:50:43

When no frames are received from the modbus master, the alarm condition is present. When the condition has been present for a period equal to or longer than the delay and in case the alarm is enabled, the alarm is provoked. When the alarm is provoked, the signal selected will be activated and the action selected will be taken. The alarm is automatically acknowledged in case auto ack. is enabled.

Fuel level alarm

ENcombi

ADMIN

Fuel Level alarm

Threshold:	20 %
Delay:	5.0 s
Enable:	DISABLED
Signal:	DISABLED
Action:	NOTIFICATION
Auto ack.:	DISABLED



Fuel level alarm setup page.
 When Fuel level goes below the threshold the alarm condition is present.
 When condition has been present for a periode equal to or longer than the delay and in case the alarm is enabled the alarm is provoked.
 When alarm is provoked, the signal selected will be activated and the action selected will be taken.
 The alarm is automatically acknowledged in case auto ack. is enabled.

2022-03-14-12:00:09

When fuel level goes below the threshold, the alarm conditions are present. When the condition has been present for a period equal to or longer than the delay and in case the alarm is enabled, the alarm is provoked. When the alarm is provoked, the signal selected will be activated and the action selected will be taken. The alarm is automatically acknowledged in case auto ack. is enabled.

Inverter production deviation alarm

ENcombi

ADMIN

Inv deviation alarm

Threshold:	5.0 kW
Delay:	600 s
Enable:	DISABLED
Signal:	DISABLED
Action:	NOTIFICATION
Auto ack.:	ENABLED



inverter production deviation alarm setup page.
 When the difference between the highest and lowest power produced by the inverter goes above the threshold the alarm condition is present.
 When condition has been present for a periode equal to or longer than the delay and in case the alarm is enabled the alarm is provoked.
 When alarm is provoked, the signal selected will be activated and the action selected will be taken.
 The alarm is automatically acknowledged in case auto ack. is enabled.

2022-11-09-00:10:42

This alarm monitors the spread in production amongst the inverters. When the difference between the highest producing inverter and the lowest producing inverter goes above the threshold, the alarm conditions are present. When the condition has been present for a period equal to or longer than the delay and in case the alarm is enabled, the alarm is provoked. When the alarm is provoked, the signal selected will be activated and the action selected will be taken. The alarm is automatically acknowledged in case auto ack. is enabled.

Common master communication

ENcombi

ADMIN

Comm alarm

Delay:	60.0 s
Enable:	ENABLED
Signal:	DISABLED
Action:	NOTIFICATION
Auto ack.:	ENABLED



Common modbus master communication alarm setup page. When any modbus master communication alarm is triggered, then the alarm condition is present. When the condition has been present for a periode equal to or longer than the delay, and in case the alarm is enabled, the alarm is provoked. When the alarm is provoked, the signal selected will be activated and the action selected will be taken. The alarm is automatically acknowledged in case auto ack. is enabled.

2022-03-10-10:13:08

This alarm condition is present in case any of the modbus master communication alarms for the inverter, power meter, sensor or IO communication are raised. When the condition has been present for a period equal to or longer than the delay and in case the alarm is enabled, the alarm is provoked. When the alarm is provoked, the signal selected will be activated and the action selected will be taken. The alarm is automatically acknowledged in case auto ack. is enabled.

Modbus Master comm. alarms

ENcombi

ADMIN

Master alarms

Power meter:	10
Inverter:	10
Sensor:	10
IO:	10
Inhibit night:	DISABLED
Inhibit POA:	DISABLED
POA threshold:	20 W/m2



Modbus master communication alarm setup page. The number of timeouts to encounter before the respective alarm is raised can be set here. This way the sensitivity of the various Modbus Master related communication alarms can be adjusted. Mail and FTP transfer are suppressed in case the respective timeout is set lower than the value of 10. Inhibit of inverter communication alarm can be enabled based on night time and irradiance respectively.

2022-11-09-00:09:08

Here the sensitivity of the Modbus Master communication alarms can be adjusted. The settings dictates the number of timeouts to encounter before the respective Modus Master alarm is raised. Furthermore it is possible to inhibit the inverter related communication alarms based on night time condition and/or low irradiance.

Overview

When all settings are made, clicking the overview button leads to the below page providing a quick overview of the configuration made including protocols, baud rates, IDs/IPs selected for inverter, meters and sensors etc.

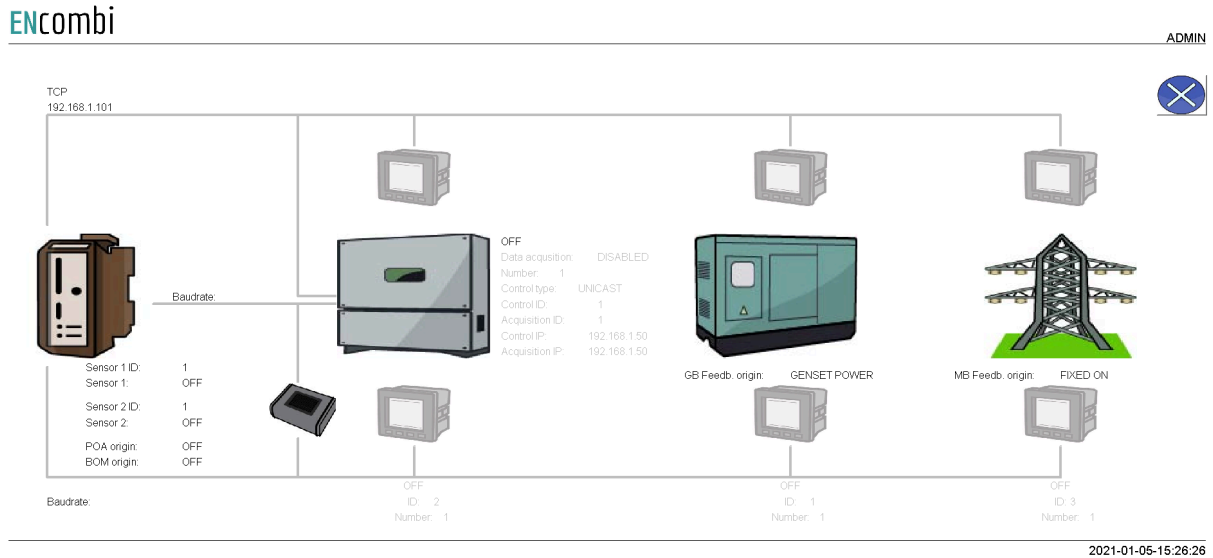



Nighttime

Clicking the Nighttime button leads to the page below where the nighttime period can be defined.

ENcombi ADMIN

Night time

Start hour:	18 h		
Start minute:	0 min	<p>Night time setup page. Here the night time period can be defined using the night time start and night time stop settings.</p>	
Stop hour:	6 h		
Stop minute:	0 min		

2020-07-10-13:51:58

Whether nighttime or daytime period is active can be used for switching the P/Q priority of the PV plant for instance.



Simulation

Clicking the simulation button leads to the page below where the simulation mode can be enabled/disabled.

ENcombi ADMIN

Simulation

Simulation: ENABLED

Simulation setup page.

Simulation enables you to try out the ECpv in an office environment without the need of being connected to any real equipment. When simulation is enabled a button will appear on the overview page. Here various stimuli like active and reactive loads can be applied. Run through the various control schemes and see their behaviour. Check out how data on plant level to component level is visualised.

Additional settings required when using simulation:

- 1) GB feedback origin: Meter communication.
- 2) Gesent kW origin: Genset Meter.
- 3) MB feedback origin: Meter communication.
- 4) Mains kW origin: Mains meter.
- 5) PV kW origin: PV meter or Inverter Acquisition.
- 6) Inverter control: Enable.
- 7) Inverter acquisition: Enable.

Communication towards power meters, inverters etc. must be disabled. The number of power meters and inverters selected will however reflect on the visualization as in real operation. Also the rated size set up for the PV plant, genset etc. will have the normal impact.

2020-07-10-13:52:18

Simulation enables you to try out the ECpv2 in an office environment without the need of being connected to any real equipment. When simulation is enabled a button will appear on the monitoring overview page. Here various stimuli like active and reactive loads can be applied. Run through the various control schemes and see their behavior. Check out how data on plant level to component level is visualized.

Additional settings required when using simulation:

- 1) GB feedback origin: Meter communication.
- 2) Gesent kW origin: Genset Meter.
- 3) MB feedback origin: Meter communication.
- 4) Mains kW origin: Mains meter.
- 5) PV kW origin: PV meter or Inverter Acquisition.
- 6) Inverter control: Enable.
- 7) Inverter acquisition: Enable.

Furthermore, communication towards power meters, inverters etc. must be disabled. The number of power meters and inverters selected will however reflect on the visualization as in real operation. Also the rated size set up for the PV plant, genset etc. will have the normal impact.

Proprietary modbus pages

Clicking the pages button leads to the following page.

ENcombi ADMIN

Pages	
SunSpec slave:	DISABLED
Proprietary slave:	ENABLED
Page 1:	ENABLED
Page 2:	ENABLED
Page 3:	DISABLED
Page 4:	ENABLED
Page 5:	DISABLED
Page 6:	DISABLED



Modbus slave page config.

In case SunSpec slave is enabled, the device will accept references received from a SunSpec master.

In case Proprietary slave is enabled, the device will accept references etc. received from a Modbus master. The individual proprietary pages can be enabled here. Consult the Modbus Slave documentation to learn the content of each page.



2021-11-11-14:36:18

In case SunSpec slave is enabled, the ECpv2 will accept references received from a SunSpec master. In case disabled the reference will be generated by the ECpv2's own setup found under genset or mains settings depending on whether paralleling to genset or mains is ongoing.

In case Proprietary slave is enabled, the ECpv2 will accept instructions to be received over modbus via a dedicated proprietary modbus profile. The various instructions are furthermore grouped together in different pages that need to be enabled individually. Consult the Modbus slave documentation on ENcombi website for detailed information about the proprietary modbus profile.

<http://www.encombi.com/products/ECpv2/>

Clicking the button on the right hand site leads to the Configurable Modbus area page.

Configurable Modbus

Address: 0 → 21000	Address: 0 → 21016	Address: 0 → 21032	
0 → 21001	0 → 21017	0 → 21033	
0 → 21002	0 → 21018	0 → 21034	
0 → 21003	0 → 21019	0 → 21035	
0 → 21004	0 → 21020	0 → 21036	
0 → 21005	0 → 21021	0 → 21037	
0 → 21006	0 → 21022	0 → 21038	
0 → 21007	0 → 21023	0 → 21039	
0 → 21008	0 → 21024	0 → 21040	
0 → 21009	0 → 21025	0 → 21041	
0 → 21010	0 → 21026	0 → 21042	
0 → 21011	0 → 21027	0 → 21043	
0 → 21012	0 → 21028	0 → 21044	
0 → 21013	0 → 21029	0 → 21045	
0 → 21014	0 → 21030	0 → 21046	
0 → 21015	0 → 21031	0 → 21047	

Configurable modbus area

2021-11-11-14:36:45

Here it is possible to tailor your own modbus mapping. Data elements that are scattered around the standard modbus map (function code 0x04) can be mapped and concentrated to the Configurable Modbus area.

Monitoring

Clicking the monitoring button leads to the following page.

Monitoring

Monitoring Total DISABLED



Monitoring setup page.

Monitoring on ECweb will per default only display the Genset and Grid power and the Load consumption that is connected to the same busbar as the PV. The same applies for the Modbus and subsequently the ECpanel and ECcloud. Also the energy counters and its derivatives will only increment based on the Genset and Grid power generated when connected to the same busbar as the PV. With the designated setting this can be changed so the total values measured are used instead throughout it all.

2023-05-23-11:55:25

Monitoring on ECweb will by default only display the Genset and Grid power and the Load consumption that is connected to the same busbar as the PV. The same applies for the Modbus and subsequently the ECpanel and ECcloud. Also the energy counters and its derivatives will only increment based on the Genset and Grid power generated when connected to the same busbar as the PV. With the designated “Monitoring total” setting this can be changed so the total values measured are used instead throughout it all.

Logs

The ECpv2 offers logging both locally on SD-card or USB-stick and as time series data pushed to an online database.

Local logs with transmission via ftp

The ECpv2 features logging stored locally on SD-card or on USB stick.
The ECpv2 can make three different logs:

- Event log
- Summary log
- Production log

The logs are stored locally on ECpv2; either on SD-card or on USB-stick.

ENcombi

ADMIN

Log config

Log drive:	SD-card
Event log:	ENABLED
Summary log:	ENABLED
Production log:	ENABLED
Log rate:	5 min

Log setup page.
 USB-key or SD-card can be used for logging.
 Use of USB-key recommended to avoid wearing SD-card.
 Three logs can be enabled/disabled independently.
 Event-log holds events and alarms.
 Summary-log holds the result of a days production.
 Production-log holds fixed interval loggings
 of production during a day.
 The logs can be read directly on web server
 as well as be transmitted via ftp or mail.
 Selected storage media must hold a "Logs" folder in the root directory.

Event log:	80		
Summary log:	502		
Production log:	551		

2020-07-10-13:53:41

A new Event log is generated every day. The event log holds entries of any events taking place or any occurrences of alarms on that particular day. All entries are time stamped.

A summary log is generated at midnight when the result of the past day is known. The log holds information about PV energy produced, revenue generated etc. The ECpv2 can be set up to send the summary logs to an FTP server automatically. The transmission will occur at midnight when a summary log is generated.

A production log is generated at midnight when a new day has started. The following midnight when the day has passed the log is completed. The log holds time-series of PV production, Mains power etc. The time interval is per default 5min. The ECpv2 can be set up to push the production logs to an FTP server automatically. The transmission will

occur at midnight when a production log is completed. The data in the production log is tabulator separated and can be imported and plotted easily in excel.

All three logs can be displayed directly on ECweb. Below example is of the production log and how it looks on ECweb. First page is a list of all the production logs available. Second page is showing data from one of those logs:

Time	PV[kW]	Gense[kW]	Mains[kW]	Load[kW]	PVcap.[kW]	PVref.[kW]	Genset[%]	POA[W/m2]	BOM[C]	Curtail Act	Start Act	GB On	MB On
00:00:51	0.0	0.0	0.0	0.0	100.0	0.0	0.0	1000.0	25.0	0	0	0	0
00:06:01	0.0	0.0	0.0	0.0	100.0	0.0	0.0	1000.0	25.0	0	0	0	0
00:11:04	0.0	0.0	0.0	0.0	100.0	0.0	0.0	1000.0	25.0	0	0	0	0
00:16:07	0.0	0.0	0.0	0.0	100.0	0.0	0.0	1000.0	25.0	0	0	0	0
00:21:09	0.0	0.0	0.0	0.0	100.0	0.0	0.0	1000.0	25.0	0	0	0	0
00:26:12	0.0	0.0	0.0	0.0	100.0	0.0	0.0	1000.0	25.0	0	0	0	0
00:31:14	0.0	0.0	0.0	0.0	100.0	0.0	0.0	1000.0	25.0	0	0	0	0
00:36:17	0.0	0.0	0.0	0.0	100.0	0.0	0.0	1000.0	25.0	0	0	0	0
00:41:20	0.0	0.0	0.0	0.0	100.0	0.0	0.0	1000.0	25.0	0	0	0	0
00:46:25	0.0	0.0	0.0	0.0	100.0	0.0	0.0	1000.0	25.0	0	0	0	0
00:51:30	80.0	0.0	20.0	100.0	100.0	80.0	0.0	1000.0	25.0	1	1	0	1
00:56:33	80.0	0.0	20.0	100.0	100.0	80.0	0.0	1000.0	25.0	1	1	0	1
01:01:36	80.0	0.0	20.0	100.0	100.0	80.0	0.0	1000.0	25.0	1	1	0	1
01:06:39	80.0	0.0	20.0	100.0	100.0	80.0	0.0	1000.0	25.0	1	1	0	1
01:11:41	80.0	0.0	20.0	100.0	100.0	80.0	0.0	1000.0	25.0	1	1	0	1

Note that the column heading of the production log shown is not actually included in the actual file being transferred by FTP. The files only contain the data itself.

In a similar way the Summary logs and Eventlog can be displayed.

Consult the "Control" chapter in this document for details on how to set up the various automatic file transmissions.

Log to MySQL database

The ECpv2 can push time series data to a MySQL database as well. This can be to an installer/customer's own hosted database or it can be to an ENcombi hosted database.

MySQL setup page.
 When enabled, the device creates a table in the selected MySQL database should it not already be present. Afterwards the device pushes data to the table at the interval selected.
 Tailor the data elements the device pushes and use your own MySQL database and preferred visualization tool. Alternatively use the Cloud service provided with the C-extra. In this case the table name and above settings are disregarded. Also the data elements pushed are fixed and can't be tailored. In case connection to the MySQL database is lost, the device buffers data to local file and will be transferred once connection is re-established. local buffer file as well as the table in the database itself can be deleted from designated buttons.
 Your device can come with free cloud service in a trial period. Below you can see if you have any free trial days available. Find the cloud service provider on the Identifiers page.

Host:	mysqlhost.com
Database:	mysql_database
Username:	mysql_username
Password:	*****
Table name:	mysql_tablename
Log rate:	5 min
Log:	ENABLED
Cloud service:	ENABLED

Buffer size:

Table size:

Free trial:

When using an installer/customer hosted database the data visualization part is in the scope of the installer/customer as well. The data to push is configurable according to the MySQL documentation on ENcombi website:

<http://www.encombi.com/products/ECpv2/>

The option of using the ENcombi database requires the dedicated SW-extra "C" or time left of any complimentary free "C" trial period. The data pushed to the ENcombi database is fixed from the ENcombi side and can't be tailored by installer/customer. The front-end for data visualization provided by ENcombi is called ECcloud. After the ECpv2 has started pushing data to the ENcombi database the customer/installer can register it in ECcloud where data will be visualized immediately.

www.encombi.online

ENcombi
Easy Energy Management

LOGIN CREDENTIALS NEW SITE PRODUCTION LOG LICENSE

Welcome to ECcloud
Please enter your credentials

Enter username
Enter password

LOGIN

EClogic

EClogic provides the possibility of making project specific logical expressions when required. That could be for linking physical digital inputs applied on power meters to the position of circuit breakers or similar. Also here, RRCR can be set up providing the option of a superior control system to give power references for the ECpv2 to follow. First page presented when clicking the EClogic tile is the page below.

EClogic main page.

EClogic is a collection of logical features to use for site customization.

The Builder offers the possibility of logically combining various input states.
This is done via graphical representation of logical gates.
Say multiple breakers/contactors need to be in certain position before the PV plant is connected to Grid, this can be tailored in the Builder.
The input to the gates are Modbus addresses and bitmasks.
It will typically be addresses holding digital input statuses from various power meters.
Consult the Modbus Slave documentation to identify the addresses of the inputs to use.
Note that the default input address "0" is interpreted as "not used".
The output of the gates are status set on dedicated Modbus addresses.
Consult the Modbus Slave documentation to identify the addresses of the outputs generated.
These statuses can then be used in the Linker to generate a command to the device.

The Linker offers the possibility of linking input states to commands.
The input states are Modbus addresses and bitmasks.
It will typically be addresses holding digital input statuses from various power meters or it can be addresses holding output status generated through the Builder.
Consult the Modbus Slave documentation to identify the addresses of the inputs to use.
Note that the default input address "0" is interpreted as "not used".
The commands available are predefined commands on dedicated Modbus addresses.
Consult the Modbus Slave documentation to identify the addresses of the available commands.

The RRCR is a dedicated configuration setup of RRCR functionality.
16 unique Power reference levels based on 4 input combinations can be configured.



EClogic is divided into five sub categories.

1. Builder
2. Linker
3. RRCR
4. Sensor
5. IO
6. Command timers
7. Command panel

Builder

The Builder offers the possibility of logically combining various input states. This is done via graphical representation of logical gates. Say multiple breakers/contactors need to be in a certain position before the PV plant is connected to the Grid, this can be tailored in the Builder.

The input to the gates are function code 0x04 Modbus addresses and bitmasks. It will typically be addresses holding digital input statuses from various power meters. Consult the Modbus Slave documentation to identify the addresses of the inputs to use. Note that the default input address "0" is interpreted as "not used".

The output/status of the gates are set on dedicated Modbus addresses. Consult the Modbus Slave documentation to identify the addresses of the outputs generated. These statuses can then be used in the Linker to generate a command to the device.

First page presented when clicking the builder button is the page below. Here an overview of the 16 builder lines supported is presented.

Each builder line consists of four gates. The status of the gates are represented by the color. Red means that the gate is false and green that the gate is true.

Clicking the line number will lead to the set up page for the specific line.

Each of the first three gates take four AND inputs and four AND NOT inputs. These three inputs are OR'ed together to generate one input to the output gate.

Example

In the configuration shown above, address 3397 bit0 is used as input to Gate1. From Modbus Slave documentation this is found to be input1 on PV meter1. As the input1 is active the Gate1 state is true which again results in the output gate to be true. This will generate the following statuses in the designated modbus area to go high.

ECLOGIC BUILDER AREA 1				
28000	Q1 gate output status line 1-16	16 unsigned int	bitwise	Not defined
28001	Q2 gate output status line 1-16	16 unsigned int	bitwise	Not defined
28002	Q3 gate output status line 1-16	16 unsigned int	bitwise	Not defined
28003	Q-out gate output status line 1-16	16 unsigned int	bitwise	Not defined
28004	Inverted Q-out gate output status line	16 unsigned int	bitwise	Not defined
28005...28999	RESERVED	Not defined	Reserved for later use	Not defined

Address 28000 bit0: Gate1, line1

Address 28003 bit0: Output Gate, line1

Linker

The Linker offers the possibility of linking input states to commands. The input states are Modbus addresses and bitmasks. It will typically be addresses holding digital input statuses from various power meters or it can be addresses holding output status generated through the Builder. Consult the Modbus Slave documentation to identify the addresses of the inputs to use. Note that the default input address "0" is interpreted as "not used".

The commands available are predefined commands on dedicated Modbus addresses. Consult the Modbus Slave documentation to identify the addresses of the available commands.

First page presented when clicking the linker button is the page below. Here the 32 linker lines supported can be set up. Furthermore, the status of each link is indicated by green and red color.

INPUTS				OUTPUTS				INPUTS				OUTPUTS			
Line:	Address:	Bit:		Address:	Bit:			Line:	Address:	Bit:		Address:	Bit:		
Line:1	28003	0		29019	0			Line:17	0	0		29000	0		
Line:2	28003	0		29053	7			Line:18	0	0		29000	0		
Line:3	28003	0		29055	2			Line:19	0	0		29000	0		
Line:4	0	0		29000	0			Line:20	0	0		29000	0		
Line:5	0	0		29000	0			Line:21	0	0		29000	0		
Line:6	0	0		29000	0			Line:22	0	0		29000	0		
Line:7	0	0		29000	0			Line:23	0	0		29000	0		
Line:8	0	0		29000	0			Line:24	0	0		29000	0		
Line:9	0	0		29000	0			Line:25	0	0		29000	0		
Line:10	0	0		29000	0			Line:26	0	0		29000	0		
Line:11	0	0		29000	0			Line:27	0	0		29000	0		
Line:12	0	0		29000	0			Line:28	0	0		29000	0		
Line:13	0	0		29000	0			Line:29	0	0		29000	0		
Line:14	0	0		29000	0			Line:30	0	0		29000	0		
Line:15	0	0		29000	0			Line:31	0	0		29000	0		
Line:16	0	0		29000	0			Line:32	0	0		29000	0		

2020-07-10-14:01:41

Example continued

In the configuration shown above address 28003 bit0 being the status of the output gate of builder line1 is used to set commands on address 29019 bit0, 29053 bit7 and 29055 bit2 respectively. From Modbus Slave documentation this is found to be the commands for:

1. Relay 1-16 on all PV meters.
2. Minimum genset load 1-8.
3. RRCR input 1-4.

















Hence activating input1 on PV meter1 has the effect of:

1. Activating relay1 on all PV meters present.
2. Overruling the parameter set under "Settings", using the Minimum genset load setting8 from ECLogic instead.
3. RRCR input3 applied.

Point 2 and 3 will be explained in the following.

Overruling of Settings parameters

On the same submenu level, a set up page for overruling certain key settings is found. Clicking the up/down arrows will lead it.

Address:	Bit:	Min. genset load:	Address:	Bit:	Genset 1:
29053	0	 20.0 %	29054	0	 100.0 kW
29053	1	 30.0 %	29054	1	 100.0 kW
29053	2	 30.0 %	29054	2	 100.0 kW
29053	3	 30.0 %	29054	3	 100.0 kW
29053	4	 30.0 %	29054	4	 100.0 kW
29053	5	 30.0 %	29054	5	 100.0 kW
29053	6	 30.0 %	29054	6	 100.0 kW
29053	7	 35.0 %	29054	7	 100.0 kW

2020-07-10-14:02:26

It is currently possible to overrule:

1. Minimum genset load.
2. Genset1 rating.
3. PV P reference.

From the example above it can be seen that ECpv2X is now using a Minimum genset load of 35% regardless of whatever value is selected under Settings. In case the input1 on PV meter1 is removed the ECpv2X will again follow the value selected under Settings. This can be useful in case gensets have different Minimum genset operating levels or if it is allowed in certain periods to operate genset(s) at a lower level.

Manipulation of the Genset1 rated power is intended for use when only one genset exists from the ECpv2X point of view (one genset meter) but in fact multiple (up to 8) are present. Depending on which genset(s) are connected to the busbar, the rated power is summarized accordingly by the ECpv2X. This way the rated power of genset1 is dynamically adjusted by the ECpv2X to match the actual combination of gensets(s) connected.



Address:	Bit:		PV PREF:
29076	0	<input checked="" type="checkbox"/>	20.0 kW
29076	1	<input checked="" type="checkbox"/>	20.0 kW
29076	2	<input checked="" type="checkbox"/>	20.0 kW
29076	3	<input checked="" type="checkbox"/>	20.0 kW
29076	4	<input checked="" type="checkbox"/>	20.0 kW
29076	5	<input checked="" type="checkbox"/>	20.0 kW
29076	6	<input checked="" type="checkbox"/>	20.0 kW
29076	7	<input checked="" type="checkbox"/>	20.0 kW

2024-04-10-12:11:03

The set points for PV can be adjusted in the same manner.

General Purpose Hysteresis

General purpose hysteresis is a generic configuration tool to trigger alarms based on different inputs.



Address:	Data type:	Data sign:	Low Threshold:	High Threshold:	Low Timer:	High Timer:	Output:	Set:	Reset:	Invert:
0	<input type="text" value="16BIT"/>	<input type="text" value="SIGNED"/>	0.0	0.0	0.0 s	0.0 s	<input checked="" type="checkbox"/>	<input type="checkbox"/>	<input type="checkbox"/>	<input checked="" type="checkbox"/>
0	<input type="text" value="16BIT"/>	<input type="text" value="SIGNED"/>	0.0	0.0	0.0 s	0.0 s	<input checked="" type="checkbox"/>	<input type="checkbox"/>	<input type="checkbox"/>	<input checked="" type="checkbox"/>
0	<input type="text" value="16BIT"/>	<input type="text" value="SIGNED"/>	0.0	0.0	0.0 s	0.0 s	<input checked="" type="checkbox"/>	<input type="checkbox"/>	<input type="checkbox"/>	<input checked="" type="checkbox"/>
0	<input type="text" value="16BIT"/>	<input type="text" value="SIGNED"/>	0.0	0.0	0.0 s	0.0 s	<input checked="" type="checkbox"/>	<input type="checkbox"/>	<input type="checkbox"/>	<input checked="" type="checkbox"/>
0	<input type="text" value="16BIT"/>	<input type="text" value="SIGNED"/>	0.0	0.0	0.0 s	0.0 s	<input checked="" type="checkbox"/>	<input type="checkbox"/>	<input type="checkbox"/>	<input checked="" type="checkbox"/>
0	<input type="text" value="16BIT"/>	<input type="text" value="SIGNED"/>	0.0	0.0	0.0 s	0.0 s	<input checked="" type="checkbox"/>	<input type="checkbox"/>	<input type="checkbox"/>	<input checked="" type="checkbox"/>
0	<input type="text" value="16BIT"/>	<input type="text" value="SIGNED"/>	0.0	0.0	0.0 s	0.0 s	<input checked="" type="checkbox"/>	<input type="checkbox"/>	<input type="checkbox"/>	<input checked="" type="checkbox"/>
0	<input type="text" value="16BIT"/>	<input type="text" value="SIGNED"/>	0.0	0.0	0.0 s	0.0 s	<input checked="" type="checkbox"/>	<input type="checkbox"/>	<input type="checkbox"/>	<input checked="" type="checkbox"/>

2021-09-21-10:45:13

The address column is the input for the flip flop. The data type and sign for the selected address must be changed according to the modbus manual for the address.

The flip flop is built up with a low threshold and a high threshold.

If the value from the address is lower than the low threshold value, the low timer will start. After the lower timer has expired, the output box will change color to green which indicates that the line is present. The status of each line can also be read out on modbus.

If the value from the address is higher than the high threshold value, the high timer will start. After the high timer expires, the output box will change color to red which indicates that the line is not present any more.

It is possible to manually force the line to be set or reset by clicking on the buttons corresponding to the line which should be forced.

Furthermore it is possible to inverse the output by clicking the button.

RRCR

The RRCR is a dedicated configuration setup of RRCR functionality.

16 unique power and cosphi reference levels based on 4 input combinations can be configured.

ENcombi ADMIN

4	3	2	1	Power limit:	Enable:	4	3	2	1	Power limit:	Enable:	
■	■	■	■	100.0 %	DISABLED	■	■	■	■	100.0 %	DISABLED	
■	■	■	■	100.0 %	DISABLED	■	■	■	■	100.0 %	DISABLED	
■	■	■	■	100.0 %	DISABLED	■	■	■	■	100.0 %	DISABLED	
■	■	■	■	100.0 %	DISABLED	■	■	■	■	100.0 %	DISABLED	
✓	■	■	■	40.0 %	ENABLED	■	■	■	■	100.0 %	DISABLED	
■	■	■	■	100.0 %	DISABLED	■	■	■	■	100.0 %	DISABLED	
■	■	■	■	100.0 %	DISABLED	■	■	■	■	100.0 %	DISABLED	
■	■	■	■	100.0 %	DISABLED	■	■	■	■	100.0 %	DISABLED	

2020-07-10-14:03:41

ENcombi ADMIN

4	3	2	1	Cosphi ref:	Enable:	4	3	2	1	Cosphi ref:	Enable:	
■	■	■	■	1.000	DISABLED	■	■	■	■	1.000	DISABLED	
■	■	■	■	1.000	DISABLED	■	■	■	■	1.000	DISABLED	
■	■	■	■	1.000	DISABLED	■	■	■	■	1.000	DISABLED	
■	■	■	■	1.000	DISABLED	■	■	■	■	1.000	DISABLED	
✓	■	■	■	1.000	DISABLED	■	■	■	■	1.000	DISABLED	
■	■	■	■	1.000	DISABLED	■	■	■	■	1.000	DISABLED	
■	■	■	■	1.000	DISABLED	■	■	■	■	1.000	DISABLED	
■	■	■	■	1.000	DISABLED	■	■	■	■	1.000	DISABLED	

2020-07-10-14:04:42

Referring to the ongoing example, as input1 on PV meter1 is active, it means that the RRCR input combination with only input3 being present is true. This is indicated by a check mark. As this line at the same time is enabled, it causes the ECpv2X to overrule whatever power reference calculated based on setup made under "Settings" and the current plant status and target the reference dictated by the RRCR instead. A limit

option is available for the power as well. When set to limit, the power output of the PV plant is limited to the chosen percentage instead of being overruled.

AIO

Toggle in the RRCR configuration will lead you to the following page.

[ENcombi](#)

ADMIN





Address:	Bit:	Address:	Data type:	Data sign:	Input reference	
29065	0	0	16BIT	SIGNED	PREF	<input checked="" type="checkbox"/>
29065	1	0	16BIT	SIGNED	QREF	<input checked="" type="checkbox"/>

2022-02-01-09:46:25



It is possible to set up an input for the reference of P and Q.
 If the address 29065, bit 0 and 1, is set, then the ECpv2X will use the reference read from the address which is typed in. This could be AIO input.
 The reference is a percentage of the rated capacity of the inverter.

Sensor

By clicking on the sensor icon, it will lead to the following page.









[ENcombi](#)

ADMIN

Address:	Data type:	Data sign:		
0	16BIT	SIGNED	→ POA	<input checked="" type="checkbox"/>
0	16BIT	SIGNED	→ BOM	<input checked="" type="checkbox"/>
0	16BIT	SIGNED	→ GHI	<input checked="" type="checkbox"/>
0	16BIT	SIGNED	→ Ambient Temp	<input checked="" type="checkbox"/>
0	16BIT	SIGNED	→ Wind speed	<input checked="" type="checkbox"/>
0	16BIT	SIGNED	→ RH	<input checked="" type="checkbox"/>
0	16BIT	SIGNED	→ BAR pressure	<input checked="" type="checkbox"/>
0	16BIT	SIGNED	→ Wind dir	<input checked="" type="checkbox"/>
0	16BIT	SIGNED	→ Rain	<input checked="" type="checkbox"/>

2022-03-14-12:03:13

Address:	Data type:	Data sign:	Scale:		
0	16BIT	SIGNED	1.0	→	Fuel Level 01 
0	16BIT	SIGNED	1.0	→	Fuel Level 02 
0	16BIT	SIGNED	1.0	→	Fuel Level 03 
0	16BIT	SIGNED	1.0	→	Fuel Level 04 
0	16BIT	SIGNED	1.0	→	Fuel Pressure 01 
0	16BIT	SIGNED	1.0	→	Fuel Pressure 02 
0	16BIT	SIGNED	1.0	→	Fuel Pressure 03 
0	16BIT	SIGNED	1.0	→	Fuel Pressure 04 



2022-04-06-13:23:16

From here it is possible to define the address of the sensor data readings. After defining the address for the specific sensor data, it should be selected in the sensor setup to read the data from “EClogic”.

The red indicator will change to green when selecting “EClogic” on the setup page of sensors.

IO

By clicking on the IO icon, it will lead to the following page.

Address:	Data type:	Data sign:	Module.Channel	Address:	Data type:	Data sign:	Module.Channel
0	16BIT	SIGNED	→ 1.1	0	16BIT	SIGNED	→ 3.1
0	16BIT	SIGNED	→ 1.2	0	16BIT	SIGNED	→ 3.2
0	16BIT	SIGNED	→ 1.3	0	16BIT	SIGNED	→ 3.3
0	16BIT	SIGNED	→ 1.4	0	16BIT	SIGNED	→ 3.4
0	16BIT	SIGNED	→ 2.1	0	16BIT	SIGNED	→ 4.1
0	16BIT	SIGNED	→ 2.2	0	16BIT	SIGNED	→ 4.2
0	16BIT	SIGNED	→ 2.3	0	16BIT	SIGNED	→ 4.3
0	16BIT	SIGNED	→ 2.4	0	16BIT	SIGNED	→ 4.4



2022-02-01-11:08:38

From here it is possible to set up which data should be linked to each output of the AIO module. All 16 outputs are present and it is possible to select which data to be sent out on each channel.

Command timers

By clicking on the command timer icon, it will lead to the following page.

Command timers 1

Start day: Mon-Sun
 Start hour: 18 h
 Start minute: 0 min
 Stop hour: 6 h
 Stop minute: 0 min



Command timer setup page.
 Here the command timer period can be defined using the command time start and command time stop settings. The output will be placed in modbus.

2022-07-14-11:51:37

It is possible to set up 4 command timers. Type in the start day and time and stop time for the command timer. The output will be available on modbus and can be used for ECllogic status/commands.

Command panel

The command panel holds 16 configurable command buttons and 16 status indicators. By clicking on the command panel icon, it will lead to the following page where the associated text strings for the 16 buttons and indicators can be typed in.

Command panel



General purpose alarms

General purpose alarms enable you to trigger your own custom made alarm. Via the EClodic Builder/Linker the trigger for the alarm is set up. A total of 8 such alarms are available.

ENcombi

ADMIN

EClodic alarm 1

Delay: 5.0 s
 Signal: DISABLED
 Action: NOTIFICATION
 Auto ack.: ENABLED
 Alarm text: EClodic AI01



EClodic alarm setup page.
 When the EClodic alarm is triggered then the alarm condition is present.
 The alarm is triggered from EClodic.
 When the condition has been present for a period equal to or longer than the delay, and in case the alarm is enabled, the alarm is provoked.
 When the alarm is provoked, the signal selected will be activated and the action selected will be taken.
 The alarm is automatically acknowledged in case auto ack. is enabled.

2022-09-30-09:47:33

The alarm trigger is set up in the EClodic Builder/Linker using the addresses below.

29068	EClodic Alarms 01..08	16 unsigned int	bitwise
-------	-----------------------	-----------------	---------

General purpose timers

General purpose timers enable you to trigger your own custom made timer. Via the EClodic Builder/Linker the trigger for the timer to be set up. A total of 8 such timers are available.

ENcombi

ADMIN

EClodic timers

Timer 1: 5.0 s
 Timer 2: 5.0 s
 Timer 3: 5.0 s
 Timer 4: 5.0 s
 Timer 5: 5.0 s
 Timer 6: 5.0 s
 Timer 7: 5.0 s
 Timer 8: 5.0 s



EClodic timer setup page.
 The commands for starting the timers are set from EClodic.
 The timer elapsed status is available in modbus and can be used as in EClodic.

2022-10-11-14:52:37

The timer triggers is set up in the EClodic builder/Linker using the addresses below:

29069	EClodic Timers 01..08	16 unsigned int	bitwise
-------	-----------------------	-----------------	---------

The output of the timers when they are elapsed are found on the addresses below:

31020	BITFIELD_21	16 unsigned int	EClogic Timers elapsed 01..16
-------	-------------	-----------------	-------------------------------

Monitoring

The ECweb provides a high level overview of the installation as well as detailed information about each individual inverter and power meter. Below is an example of the first page presented under the Monitoring tile.

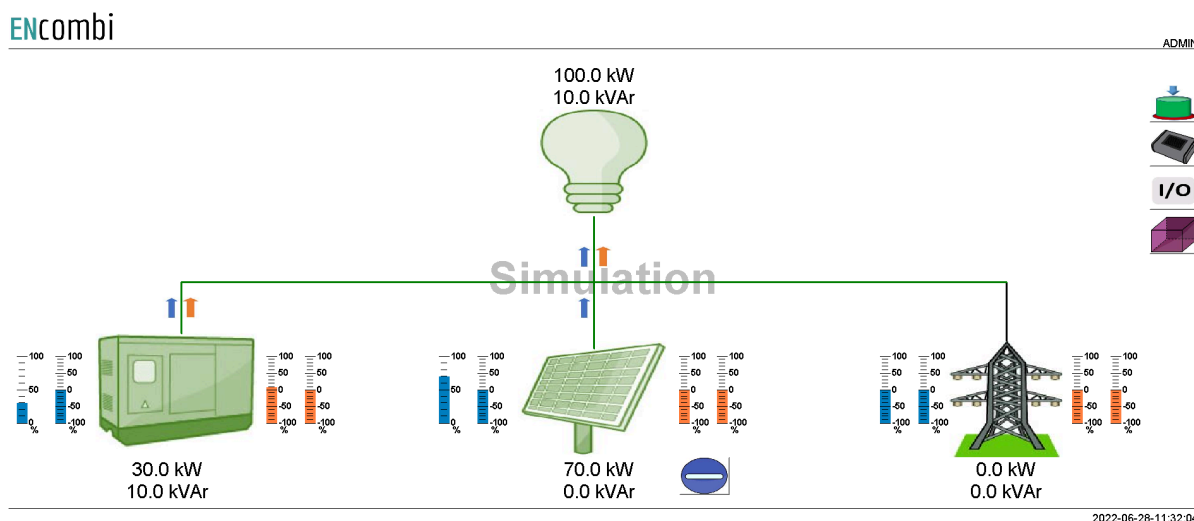

In case genset, PV or utility symbol is grayed out it means that no configuration for sensing of the associated power is made and therefore the source is interpreted as not being present by the ECpv2. The accumulated powers of the three sources as well as total consumptions are displayed.

In case the genset symbol is neither gray nor green it means that all genset breakers are off. In case the genset symbol is green it means that at least one genset breaker is on.

In case the utility symbol is neither gray nor green it means that all mains breakers are off. In case the utility symbol is green it means that at least one mains breaker is on.

In case the PV symbol is neither gray nor green it means that the start signal is not present. In case the PV symbol is green it means that the start signal is present.

In case the PV start button has a vertical line it means that the stop signal is present and the button can be clicked to start the PV plant. In case the PV button has a horizontal line it means that the start signal is present and the button can be clicked to stop the PV plant.

In case the genset start button has a vertical line it means that the stop signal is present and the button can be clicked to start the genset plant. In case the genset button has a horizontal line it means that the start signal is present and the button can be clicked to stop the genset plant. Note that this button is only visible in case Genset management functionality is enabled.

Blue and orange arrows indicate active power and reactive power flow direction respectively.

On the left hand side of the sources two blue bar graphs are shown. The one to the left shows the active power loading of the source in percentage. The one to the right shows the deviation from the active power reference in percentage.

On the right hand side of the sources two orange bar graphs are shown. The one to the left shows the reactive power loading of the source in percentage. The one to the right shows the deviation from the reactive power reference in percentage.

In the upper right corner two buttons are shown.

1. Sensor data.
2. IO module data.

Command panel

Clicking the command panel button will lead to the page below where the button commands and status indications are displayed.

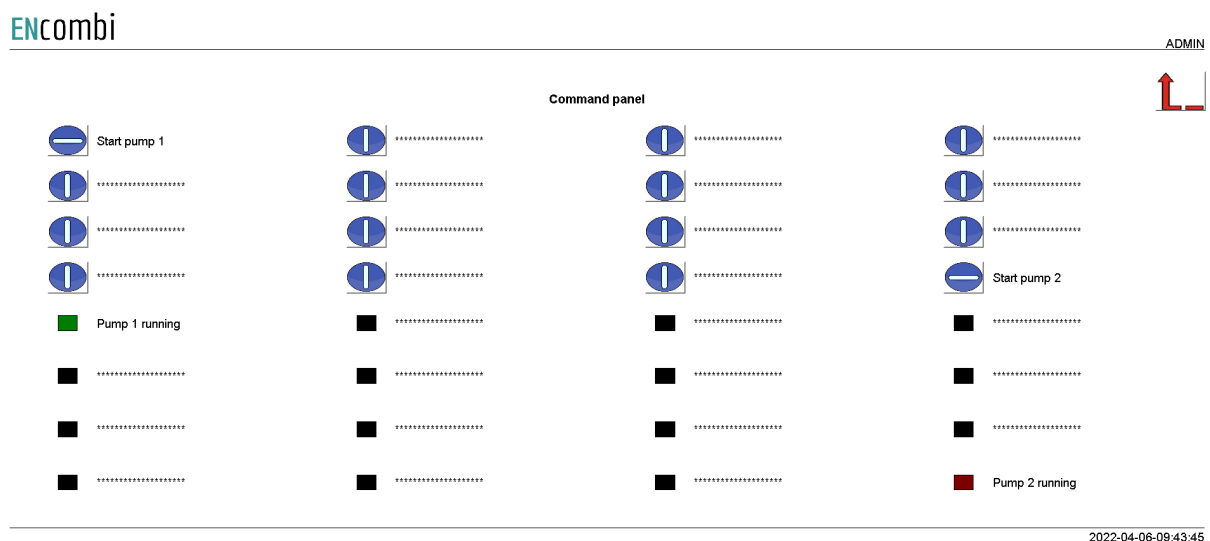

Sensor data

Clicking the sensor button will lead to the below page where an overview of all the meteorological readings is provided. If a reading is not supported or communication to the sensor or inverter providing the reading is failing, the readings will be displayed as "N.A".

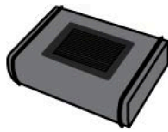

Measurement

POA:	1000 W/m ²	RH:	N.A	Fuel level 01:	45.6 %
GHI:	N.A	Bar. press.:	N.A	Fuel level 02:	N.A
BOM:	25.0 C	Wind speed:	N.A	Fuel level 03:	N.A
Amb. temp.:	N.A	Wind dir.:	N.A	Fuel level 04:	N.A
		Rain:	N.A		

2022-03-14-12:06:47

Clicking the up/down navigation buttons will lead to the page below which is displaying the fuel level data.

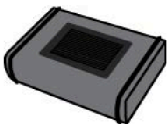

Measurement

Fuel pressure 01:	N.A	Fuel level 01:	45.6 %
Fuel pressure 02:	N.A	Fuel level 02:	N.A
Fuel pressure 03:	N.A	Fuel level 03:	N.A
Fuel pressure 04:	N.A	Fuel level 04:	N.A

2022-04-06-10:41:21

Consult the Modbus master documentation on ENcombi website for detailed information about what data is read from the various sensor and inverter models: <http://www.encombi.com/products/ECpv2/>

IO module data

Clicking the IO module button will lead to the below page where an overview of all the readings from the IO modules is provided. In case a reading is not supported or communication to the IO module is failing, the readings will be displayed as "N.A".

IO modules	IO type	IO inputs	IO outputs	Communication state:	Communication enable:
IO 1:	EX1600DD	0000 0000 0000 1000	N.A	Communication state:	Communication enable:
IO 2:	EX1608DD	0000 0000 0001 0000	0000 0000 0000 0000	Communication state:	Communication enable:
IO 3:	OFF	N.A	N.A	N.A Communication state:	N.A Communication enable:
IO 4:	OFF	N.A	N.A	N.A Communication state:	N.A Communication enable:

2020-08-18-11:18:25

Simulation

In case simulation is enabled it will be indicated as a watermark.

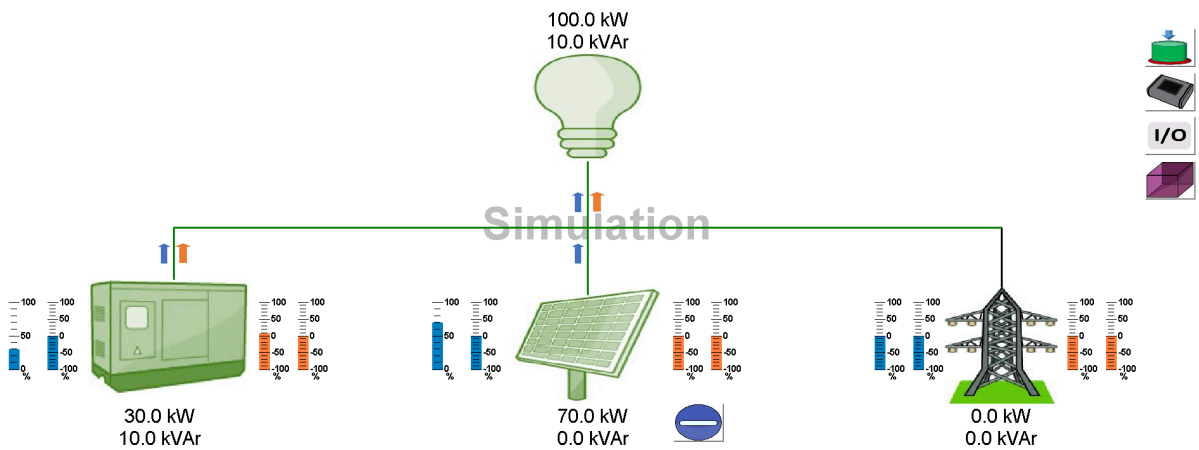

2022-06-28-11:35:08

Furthermore an additional button appears in the upper right corner which. Clicking this button will open the Stimuli page below.

ENcombi
ADMIN

Stimuli

P load: 100.0 kW

Q load: 10.0 kVAr

Grid freq: 50.0 Hz

Grid volt: 400.0 V

POA: 1000.0 W/m²

BOM: 25.0 C

Stimuli setup page.

Here the various stimuli like active and reactive loads can be applied.
Run thru the various control schemes and see their behaviour.
Check out how data on plant level to component level is visualised.
Click directly on the data to alter it.
Push breaker buttons down to simulate that respective breaker is closed.

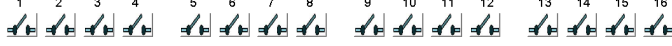

MB on:
 1 2 3 4 5 6 7 8 9 10 11 12 13 14 15 16

GB on:
 1 2 3 4 5 6 7 8 9 10 11 12 13 14 15 16





2020-07-10-14:11:29

On this page various stimuli can be applied. The changes made take effect when the window is closed. Closing the window will lead back to the monitoring page.

PV

Clicking the PV icon leads to the below pages where more detailed information of the PV plant can be found. Clicking the up/down arrows will browse through them.

ENcombi
ADMIN

References

GC: 200.0 kW

PTAR: 70.0 kW

PREF: 70.0 kW

QTAR: 0.0 kVAr

QREF: 0.0 kVAr

CURTAILMENT: ACTIVE



Production

ACP: 70.0 kW

ACQ: 0.0 kVAr

ACS: 70.0 kVA

Cosphi: 1.000 C

2021-01-05-15:39:29

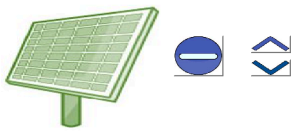

Produced

ACE: 1555 kWh
 ACE YEAR: 1555 kWh
 ACE MONTH: 1556 kWh
 ACE DAY: 939 kWh

Available

ACE: 2284 kWh
 ACE YEAR: 2284 kWh
 ACE MONTH: 2284 kWh
 ACE DAY: 1345 kWh

Curtailed

ACE: 727 kWh
 ACE YEAR: 727 kWh
 ACE MONTH: 727 kWh
 ACE DAY: 406 kWh

Penetration

PEN: 14.8 %
 PEN YEAR: 14.8 %
 PEN MONTH: 14.8 %
 PEN DAY: 99.9 %

Performance

PERF: 99.9 %
 PERF YEAR: 99.9 %
 PERF MONTH: 99.9 %
 PERF DAY: 100.0 %

2021-01-05-15:39:53

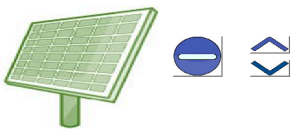

PV export save

Total: 138 Euro
 Year: 138 Euro
 Month: 138 Euro
 Day: 83 Euro

Mains imp. save

Total: 15 Euro
 Year: 15 Euro
 Month: 15 Euro
 Day: 9 Euro

2021-01-05-15:40:17

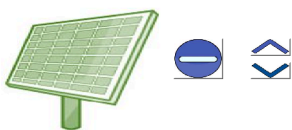

Fuel save

Total: 82 liter
 Year: 82 liter
 Month: 82 liter
 Day: 1 liter

Fuel exp. save

Total: 46 Euro
 Year: 46 Euro
 Month: 46 Euro
 Day: 1 Euro

CO2 emiss. save

Total: 217 kg
 Year: 217 kg
 Month: 217 kg
 Day: 3 kg

2021-01-05-15:40:59

On the right hand side of the above pages two buttons are presented that will lead to pages with more information about.

1. PV meter data.
2. Inverter data.

PV meter data

Clicking the meter icon will lead to the below page where overview of power and reactive power readings from all PV meters is provided. In the example below, only one PV meter is present. In case communication to a PV meter is failing, the readings will be displayed as "N.A".

ENcombi						ADMIN
PV	P	Q	PV	P	Q	
Meter 1	20.0 kW	0.0 kVAr				

2020-07-10-14:13:40

Clicking on a PV meter label, "Meter1" being the only option in the above example, will lead to a page with more detailed information about that specific PV meter.

ENcombi						ADMIN
Identifiers:			Power factors		Voltages	
Meter 1	ID2		PF 1:	1.0	L1N:	230.9 V
Comm ID:			PF 2:	1.0	L2N:	230.9 V
			PF 3:	1.0	L3N:	230.9 V
Powers			PF:	1.0	L1L2:	400.0 V
ACP 1:	6.666 kW		Currents		L2L3:	400.0 V
ACP 2:	6.666 kW		L1A:	28.868 A	L3L1:	400.0 V
ACP 3:	6.666 kW		L2A:	28.868 A	Frequencies	
ACP:	20.0 kW		L3A:	28.868 A	HZ 1:	50.0 Hz
ACQ 1:	0.0 kVAr		LNA:	0.0 A	HZ 2:	50.0 Hz
ACQ 2:	0.0 kVAr		Produced		HZ 3:	50.0 Hz
ACQ 3:	0.0 kVAr		ACE:	N.A.	Status	
ACQ:	0.0 kVAr		ACE IMP:	N.A.	Inputs:	0000 0000 0000 0000
ACS 1:	6.666 kVA		ACE EXP:	N.A.		
ACS 2:	6.666 kVA		ACRE:	N.A.		
ACS 3:	6.666 kVA		ACRE IND:	N.A.		
ACS:	20.0 kVA		ACRE CAP:	N.A.		
					Communication state:	
					Communication enable:	

2020-07-10-14:13:57

In the upper left corner the label of the meter can be changed. In the lower right corner communication status for the specific PV meter is shown. In case the PV meter is failing

to communicate for whatever reason, communication to that specific meter can be disabled and enabled again at a later state on the start/stop button. Not all data shown is read/displayed from all meter models supported and will in that case show "N.A.". Consult the Modbus master documentation on ENcombi website for detailed information about what data is read from the various meter models.

<http://www.encombi.com/products/ECpv2/>





Inverter data

Clicking the inverter icon will lead to the below page where overview of power and reactive power readings from all inverters is provided. In case communication to an inverter is failing, the readings will be displayed as "N.A."

ENcombi						ADMIN
Inverter	P	Q	Inverter	P	Q	
Inverter 1	5.0 kW	0.0 kVAr				
Inverter 2	5.0 kW	0.0 kVAr				
Inverter 3	5.0 kW	0.0 kVAr				
Inverter 4	5.0 kW	0.0 kVAr				

2020-07-10-14:14:31

Clicking on an inverter label will lead to a page with more detailed information about that specific inverter.

ENcombi						ADMIN
Identifiers:		AC		DC		
Inverter 2	246413	L1N:	230.9 V	DCA1:	1.6 A	
Serial:	Virtual	L2N:	230.9 V	DCU1:	713.1 V	
Model:	1.00.0	L3N:	230.9 V	DCP1:	1.2 kW	
Version:	ID2	L1L2:	400.0 V	DCA2:	1.6 A	
Comm ID:		L2L3:	400.0 V	DCU2:	713.1 V	
		L3L1:	400.0 V	DCP2:	1.2 kW	
Production		L1A:	7.2 A	DCA3:	1.6 A	
ACP:	5.0 kW	L2A:	7.2 A	DCU3:	713.1 V	
ACQ:	0.0 kVAr	L3A:	7.2 A	DCP3:	1.2 kW	
ACS:	5.0 kVA	HZ:	50.0 Hz	DCA4:	1.6 A	
PF:	1.0			DCU4:	713.1 V	
				DCP4:	1.2 kW	
Produced		Status				
ACE:	N.A.	CAB TEMP:	49.8 C			
ACE DAY:	N.A.	STATE:	N.A.			
OPE:	N.A.	EVT1:	N.A.			
OPE DAY:	N.A.	EVT2:	N.A.			
		EVT3:	N.A.			
		EVT4:	N.A.			
				Communication state:		
				Communication enable:		

2020-07-10-14:15:07

In the upper left corner the label of the inverter can be changed. In the lower right corner communication status for the specific inverter is shown. In case the inverter is

failing to communicate for whatever reason, communication to that specific inverter can be disabled and enabled again at a later state on the start/stop button.

Not all data shown is read/displayed from all inverter models supported and will in that case show "N.A.". Consult the Modbus master documentation on ENcombi website for detailed information about what data is read from the various inverter models.

<http://www.encombi.com/products/ECpv2/>

Genset

Clicking the genset icon leads to the below page where more detailed information of the genset plant can be found.

ENcombi

ADMIN



Production

ACP: 30.0 kW
 ACQ: 10.0 kVA
 ACS: 31.6 kVA
 Cosphi: 0.948 C

Fuel consumed

Total: 2262 liter
 Year: 2262 liter
 Month: 2262 liter
 Day: 1 liter

Produced

ACE: 8844 kWh
 ACE YEAR: 8844 kWh
 ACE MONTH: 8844 kWh
 ACE DAY: 2 kWh

LOADING:

GC: 100.0 kW
 LOADING: 30.0 %
 PTAR: 30.0 %

Fuel expense

Total: 2784 Euro
 Year: 2784 Euro
 Month: 2784 Euro
 Day: 1 Euro

CO2 emission

Total: 5973 kg
 Year: 5973 kg
 Month: 5973 kg
 Day: 1 kg

2021-01-05-15:41:54

On the right hand side of the above pages a button is presented that will lead to pages with more information about genset meters.

Genset meter data

Clicking the meter icon will lead to similar pages holding genset meter data as already documented previously for PV meters. Refer to that chapter for more information.

Mains

Clicking the utility icon leads to the below page where more detailed information of the utility can be found.

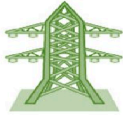

Production

ACP: 0.0 kW
 ACQ: 0.0 kVAr
 ACS: 0.0 kVA
 Cosphi: 1.000 C

Imported

ACE: 0 kWh
 ACE YEAR: 0 kWh
 ACE MONTH: 0 kWh
 ACE DAY: 0 kWh
 Total: 0 Euro
 Year: 0 Euro
 Month: 0 Euro
 Day: 0 Euro

Exported

ACE: 0 kWh
 ACE YEAR: 0 kWh
 ACE MONTH: 0 kWh
 ACE DAY: 0 kWh
 Total: 0 Euro
 Year: 0 Euro
 Month: 0 Euro
 Day: 0 Euro

On the right hand side of the above pages a button is presented that will lead to pages with more information about mains meters.

Mains meter data

Clicking the meter icon will lead to similar pages holding mains meter data as already documented previously for PV meters. Refer to that chapter for more information.

Spot price market data

Clicking the spot price button will lead to the page below where the hourly spot prices can be seen.

Spot price

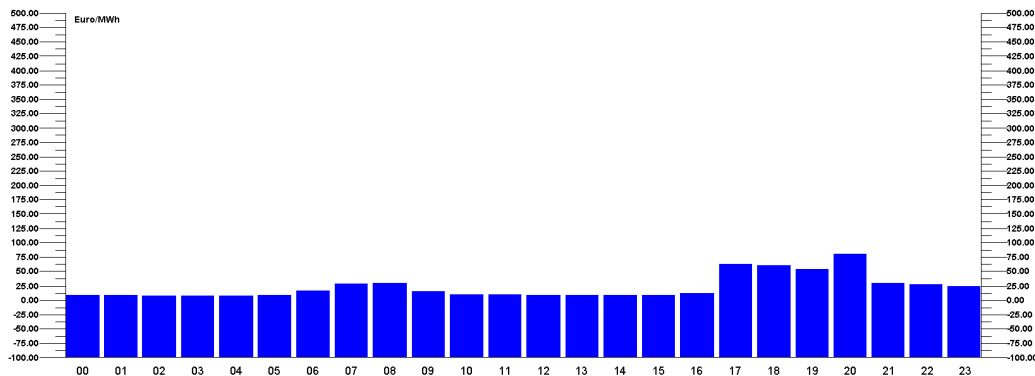

Load

Clicking the load icon leads to the below page where more detailed information of the load can be found.



Consumption

ACP: 100.0 kW
 ACQ: 10.0 kVAr
 ACS: 100.5 kVA
 Cosphi: 0.995 C

Consumed

ACE: 9 kWh
 ACE YEAR: 9 kWh
 ACE MONTH: 9 kWh
 ACE DAY: 9 kWh



ECpv2 as power meter

An ECpv2 can serve as a power meter(s) to another ECpv2. This means that one ECpv2 can read the power meter data, via either Modbus RTU or Modbus TCP, polled by another ECpv2. This is useful in cases like the below examples where two PV plants are present in the same system. Both examples show inverters controlled via Modbus TCP but it could just as well have been Modbus RTU.

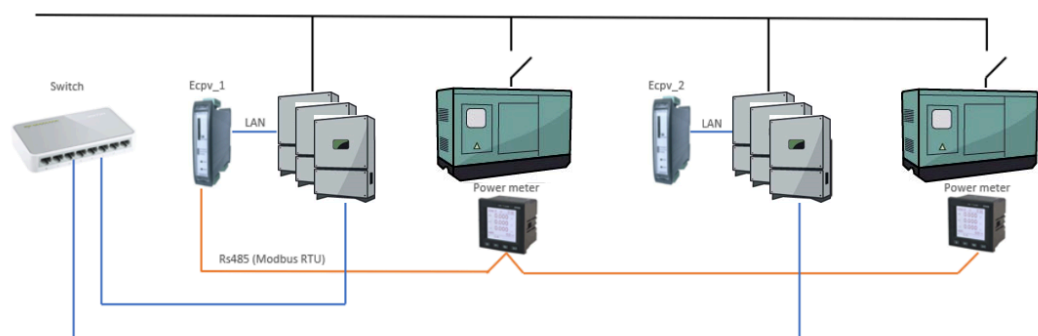

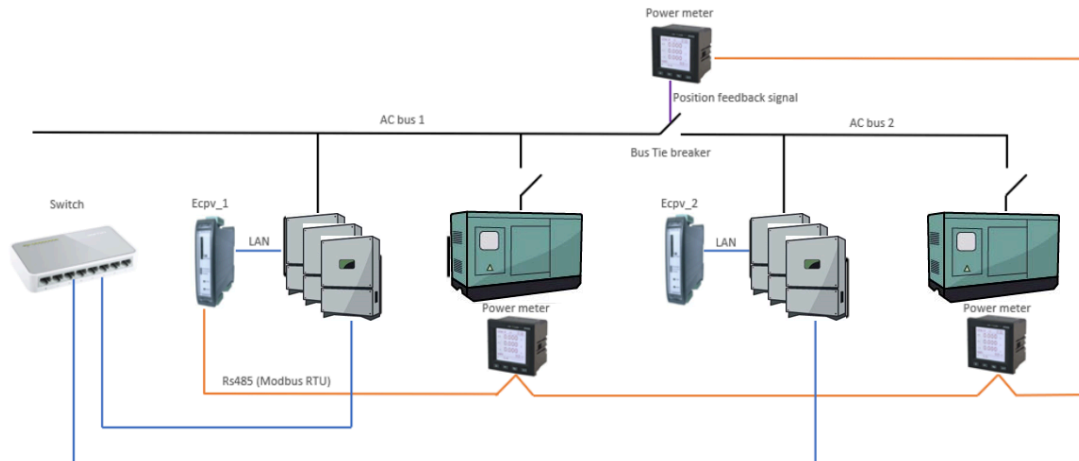

In the examples ECpv2_1 is reading the data from the power meters via Modbus RTU. ECpv2_2 is getting the same information but it is reading it via Modbus TCP from ECpv2_1.

This is a very useful feature as both ECpv2s requires the information from power meters and you would otherwise need to install an additional component in the shape of a Modbus RTU Multiplexer to allow both ECpv2s to act as Modbus Masters towards the power meters and read out the data.

It is configured in the same manner as described in the previous chapter of power meter configuration. Below is an example with genset meter configuration.

ENcombi
ADMIN

Genset	
Power meter:	ENCOMBI ECPV
Modbus type:	TCP
ID:	1
IP:	192.168.1.79
Number:	2

Genset power meter setup page.
 A maximum of 16 power meters for gensets is supported.
 The same make/model must be used for all genset measurements.
 The communication can be either Modbus RTU or TCP.

The Modbus IDs of the meters must be sequential
 in case of RTU, with lowest ID being equal to the
 setting made in the device.

The IP addresses of the meters must be sequential,
 in case of TCP, with lowest IP address being equal to the
 setting made in the device.

The Modbus ID selected is used in the TCP frames.

Port settings is setup on dedicated port setup page.

2020-07-10-14:38:10

Note that the ECpv2 will be reading data of multiple power meters from a single ECpv2. In the above configuration the ECpv2 will be reading data from two genset power meters from an ECpv2 having IP address 192.168.1.79.

ECpv2 stacking

Inverter stacking

A single ECpv2 can control and monitor a maximum of 32 inverters all which must be from the same vendor and possibly of the same model. If to control more than 32 inverters or a mix of inverter makes/models multiple ECpv2's can be stacked and worked together as illustrated in the schematic below.

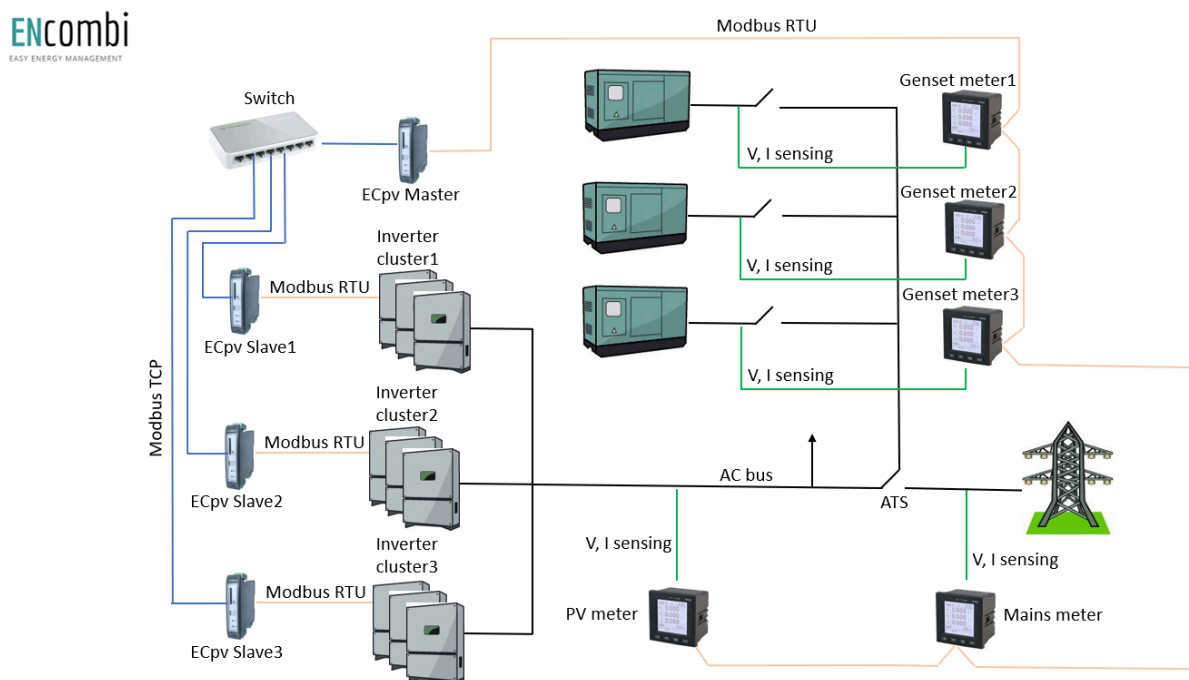

In the above example three clusters of inverters are present. These clusters can each contain up to 32 inverters and can be of another make/model than the inverters used in the other inverter clusters.

ECpv2 slave

Each cluster is controlled by a slave ECpv2. That can be via Modbus RTU as in the above example or it can be via Modbus TCP.

For PV reference under the Settings tile, these three ECpv2 will be configured as being SunSpec slaves.

References

Priority:	OFF
Cosphi cap:	0.600 C
Cosphi ind:	0.600 I
Cosphi lim:	DISABLED
Proprietary slave:	ENABLED
SunSpec slave:	DISABLED
Sensing method:	SUM ALL PHASES
Measurement	
kW Origin:	PV METER
kWh Origin:	ECPV



PV reference setup page.
Priority setting determines whether to prioritise P or Q reference over the other in case exceeding rated S inverter capacity.

Cosphi cap and Cosphi ind outlines operating range of the inverters. In case enabled and reference exceeding, the device will limit the Q reference.

In case Proprietary slave is enabled, the device will accept references received from a Modbus master.

In case SunSpec slave is enabled, the device will accept references received from a SunSpec master.

Sensing method determines if to base reference on the sum of all phases or 3 x sensing values.

AC origin determines from which source the PV production arises.

kWh origin determines from which source the genset energy production arises.



2021-01-06-15:52:02

The inverter protocol itself to select in the ECpv2 slaves is determined by the make/model of inverters inside their respective inverter clusters.

ECpv2 Master

The fourth ECpv2 will act as a normal ECpv2 which interacts with the gensets and utility connections.

It will see the three ECpv2 slaves simply as three (big) inverters running SunSpec, being ignorant to the fact that it is actually three clusters of inverters. Therefore the inverter protocol to select in the master ECpv2 must be SunSpec. The connection to the ECpv2 slaves can be Modbus TCP as in the above example or it can be Modbus RTU.

As an ECpv2 can control up to 32 inverters, the maximum capacity of an ECpv2 master will be 32 inverter clusters. Should this not be sufficient yet another ECpv2 master can be applied on top of up to 32 ECpv2 masters and so on.

Genset stacking

A single ECpv2 can monitor a maximum of 16 genset power meters all which must be from the same vendor and possibly of the same model. If to monitor more than 16 genset power meters or a mix of makers/models multiple ECpv2's can be stacked and worked together as illustrated in the schematic below.

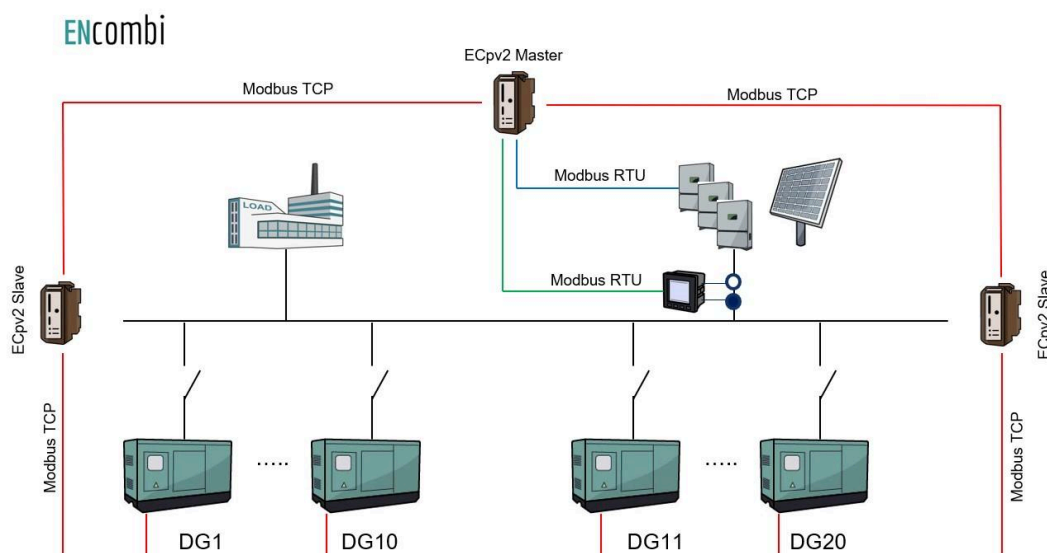

In the above example two Groups of gensets are present. These groups can each contain up to 16 genset power meters and can be of another make/model than the power meters used in the other genset groups.

ECp2 slave

Each group is controlled by a slave ECp2. That can be via Modbus TCP as in the above example or it can be via Modbus RTU.

The genset power meter protocol itself to select in the ECp2 slaves is determined by the make/model of power meters inside their respective group.

ECp2 Master

The third ECp2 will act as a normal ECp2 which interacts with the gensets and other connections.

It will see the two ECp2 slaves simply as two (big) gensets, being ignorant to the fact that it is actually two groups of gensets. Therefore the genset power meter protocol to select in the master ECp2 must be "ENcombi DG Group". The connection to the ECp2 slaves can be Modbus TCP as in the above example or it can be Modbus RTU.

As an ECp2 can control up to 16 genset power meters, the maximum capacity of an ECp2 master will be 16 genset groups. Should this not be sufficient yet another ECp2 master can be applied on top of up to 16 ECp2 masters and so on.

Service Tool

First page to be displayed after an initial welcome page when switching to the Service Tool application is the front page of ECweb.

ENcombi



Select your category

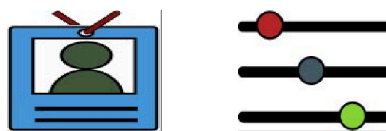

2020-07-26-10:57:51

Navigating around in the Service Tool is done in the same manner as in the ECpv2X application.

In the lower center two menu tiles are available. These are from the left:

1. "Identifiers" gives access to an overview of the SW version installed as well as to the menu for switching between the applications.
2. "Settings" give access to the set up of various features.

In the following chapters the content of the two menu tiles are discussed in detail.

Identifiers

Under this tile overview of SW version installed and extras present in the ECpv2X as well as to the menu for switching between the applications.

ENcombi

Company:

Name:	Website:	Contact:	Support:	Cloud service:
ENcombi	www.encombi.com	sales@encombi.com	support@encombi.com	www.encombi.online



Product:

Type:	Extras:	Project version:	Serial number:
ECpvx Service Tool	-C-L-	1.00.0	202105040001

Platform:

Device type:	Device variant:	Chip type:	Rtos:	Version:
WP240X	COM	SC24	V2.07 FULL	V23.9.63.1

Identifiers:

Serial number 1:	Serial number 2:	MAC address:
14738AC71464B148	37648890F9A0D012	003056914973

2021-09-20-14:22:53

On the right hand side there is one submenu for.

1. Application switch.

Application

Clicking the Application button leads to the page below. Here it can be selected which application is to be active.

ENcombi

Application

Application: ECPVX SERVICE TOOL



Application swap page.
 Here it is set up which application to run.
 When toggling between applications, the device is to be reboot. Any settings made in the ECPvx application will be lost in the process. Store a backup before leaving the ECPvx project if any settings are made that is to be restored when reverting to the ECPvx application. Browser needs refreshing when the device has rebooted.

2021-09-20-14:23:22

The following applications are available.

1. ECpv2X.
2. ECpv2X Service Tool.
3. ECpv2X Boot.

ECpv2X is the default application and the one to use for the normal operation of the ECpv2X. ECpv2X Service Tool is a separate application that offers various tests and configuration features and the ECpv2X Boot is a tool for updating both the ECpv2X and the ECpv2X Service Tool SW.

When toggling between applications the device is to be rebooted. Any settings made in the ECpv2X application will be lost in the process. Make a backup before leaving the ECpv2X application if any settings are made that are to be restored when reverting to the ECpv2X application once again. The browser needs refreshing when the device is rebooted after switching the application.

Settings

Under this tile the setup of various features are found.

First page presented when clicking the Settings tile is the below page where COM2 configuration is set up.

ENcombi

COM2 port

Baudrate: 19200

Parity: NO PARITY 1 STOP BIT

Timeout: 1.0 s

TX rate: 1.0 s

Slave ID: 1



COM2 Port setup page.
Baudrates supported are 9600, 19200, 38400 and 115200.

Power meter RTU communication is fixed on COM2.
Sensor and IO module RTU communication is optional on COM2.
In case none of these communications are enabled, COM2 is serving as a Modbus RTU slave.

Slave ID is only used in case COM2 is serving as a slave.



2022-03-11-15:08:56

Baud rates supported are:

- 9600, 19200, 38400 and 115200

Parity supported are:

- "Parity one stop bit", "No parity", "Even parity" and "Odd parity".

On the same menu level, a similar setup page for COM3 configuration is found. Clicking the up/down arrows will lead to it.

On the right hand side there are two submenus for.

1. Power meter configuration.
2. IO modules
3. Modbus Tester.
4. Client Trace.

Power meter configuration

Power meter configuration allows you to read and write the configurations of various power meters over Modbus. Clicking the Power meter button leads to the page below where a Pilot SPM32 power meter can be configured.

ENcombi

SPM32 config

Baudrate:	9600	
CT ratio:	1	
VT ratio:	1	
Conn mode:	3 Phase 4 Wire	
Modbus ID:	1	1

SPM32 setup page.
 Here a SPM32 power meter can be set up.
 It is fixed to use COM2.
 Port settings is setup at dedicated port setup page.
 Connect A(-) on the ECpv to RS485+ on the SPM32 and
 Connect B(+) on the ECpv to RS485- on the SPM32.
 Note that the SPM32 Modbus ID is set via the
 dipswitches on the back side.

2020-07-31-13:18:19

Clicking up/down buttons will navigate through all the meter power meter configurators supported. Currently the following are supported:

1. Pilot SPM32.
2. Pilot SPM33.

IO configuration

IO configuration allows you to read and write the configurations of IO modules over Modbus. Clicking the IO button leads to the page below where COM2 or COM3 can be selected.

ENcombi

IO modules

COM port:	COM2	
-----------	------	--

IO module setup page.
 IO module communication can either run Modbus RTU or Modbus TCP.
 Whether to use COM2, COM3 or TCP is selectable by parameter.
 Port settings is setup at dedicated port setup page.

2021-09-20-14:29:30

Afterwards clicking on the IO configuration button on the right hand side leads to the IO configuration page.

ENcombi

IO module comm.



Baudrate: 9600

Parity: EVEN PARITY

Modbus ID: -

Timeout: -

IO module search

Modbus ID:   

Module: N.A.





FW version: N.A.

 Overdigit IO module communication setup page.

After IO module is powered up, then press the PG button on the IO module for 3s until the green LED starts flashing. Now the IO module is in a temporary state having the Baudrate and Parity listed in the colored Active Column. Note that the COM port selected for IO module communication must be configured accordingly to complete the configuration successfully. In the update column the requested communication setup is made and Save button is pushed to write it to the IO module. Afterwards, press the PG button again to stop the green LED flashing and activate the communication setup just made.

The Timeout determines the delay for no communication being active before the IO module releases all its relays. Setting it to "0 x 10ms" means disabling the functionality and the IO module will keep the relays at there states in case of communication loss.

Search a Modbus ID to find module type and firmware version.

2022-02-07-14:32:39

It is possible to set up the Overdigit IO module with the tool.

After the IO module is powered up, then press the PG button on the IO module for 3s until the green LED starts flashing. Now the IO module is in a temporary state, having the Baudrate and Parity listed in the colored Active Column. Note that the COM port selected for IO module communication must be configured accordingly to complete the configuration successfully. In the update column the requested communication setup is made and the Save button is pushed to write it to the IO module. Afterwards, press the PG button again to stop the green LED flashing and activate the communication setup just made.

The Timeout determines the delay for no communication being active before the IO module releases all its relays. Setting it to "0 x 10ms" means disabling the functionality and the IO module will keep the relays at their states in case of communication loss.

AIO

When pressing the settings icon, it will lead to the following page.

ENcombi

EX04AIO config

Channel 1 type:	OFF
Channel 1 source:	0-10V
Channel 2 type:	OFF
Channel 2 source:	0-10V
Channel 3 type:	OFF
Channel 3 source:	0-10V
Channel 4 type:	OFF
Channel 4 source:	0-10V
Modbus ID:	-



Overdigit AIO module communication setup page.
 Here an EX04AIO can be set up.
 It is optional which port to use. It is setup at dedicated COM page.
 Port settings is setup at dedicated port setup page.
 Setup input and output for all 4 channels.
 Modbus ID needs to be set in order to write configuration.

2022-02-07-14:34:29

From there it is possible to set up an EX04AIO module. From here it is selectable which channel to use for input and output. All 4 channels can be selected as off, input and output. It is also selectable which source the input or output should work with. The two options are 0-10 or 4-20mA. When the configuration is ready, the modbus ID must be set and after that it is possible to write the configuration to the module. An icon will show if the writing was successful or failed.

Toggle to the next page will lead to the set up of EX04AIS.

ENcombi

EX04AIS config

Channel 1 source:	OFF
Channel 2 source:	OFF
Channel 3 source:	OFF
Channel 4 source:	OFF
Modbus ID:	-



Overdigit AIS module communication setup page.
 Here an EX04AIS can be set up.
 It is optional which port to use. It is setup at dedicated COM page.
 Port settings is setup at dedicated port setup page.
 Setup input for all 4 channels.
 Modbus ID needs to be set in order to write configuration.

2022-02-08-09:42:21

These are only inputs, so the only configuration is which source the channels should be. It can also be selected as OFF, which means the channel is deactivated.

Sensor Configuration

The Sensor configuration allows you to read and write the configurations of various sensors over Modbus. Clicking the Sensor button leads to the page below where it is set up whether the Sensor configuration is to use COM2 or COM3.

ENcombi

Sensors

COM port: COM2



Sensor setup page.
Sensor communication is running Modbus RTU only.
Whether to use COM2 or COM3 is selectable by parameter.
Port settings is setup at dedicated port setup page.





2022-03-11-15-07:41

Afterwards, clicking on the setup button on the right hand side leads to the Sensor configuration itself where the Sensor modules communication settings can be adjusted and the Sensor modules can be searched and identified.

ENcombi

SolSolare config

Baudrate:	N.A.				
Parity:	N.A.				
Modbus ID:	N.A.	60	 		
Serial:	N.A.				
FW main:	N.A.				
FW minor:	N.A.				



Soluzione Solare setup page.
Here the Soluzione Solare sensors can be set up.
Port settings are setup at dedicated port setup pages.
Connect A(-) on the ECpv to RS485+/B on the sensor and
Connect B(+) on the ECpv to RS485-/A on the sensor.



2022-03-11-15-08:02

Modbus Tester

Modbus Tester is a feature where the Service Tool acts as a Modbus RTU Master and communication with a Modbus RTU Slave can be tested. Clicking the Modbus Tester button leads to the page below where it is set up whether the Modbus Tester is to use COM2 or COM3.

Modbus tester

COM port: COM2



Modbus test page.
Here read and write commands can be tested.
The Modbus tester is for Modbus RTU only.
Whether to use COM2 or COM3 is selectable by parameter.
Port settings is setup at dedicated port setup page.



2020-07-26-11:17:56

Afterwards, clicking on the Modbus Tester button on the right hand side leads to the Modbus Tester itself where Modbus RTU read and write commands of various length and function codes can be transmitted and the response received is shown.

Read

Start ID:	Stop ID:	Control Fnc:	Control Fnc:	Control Fnc:	Address:	Length:	
1	1	0x03	16BIT	SIGNED	0	1	
N.A	N.A	N.A	N.A	N.A	1	N.A	
N.A	N.A	N.A	N.A	N.A	N.A		
Register 1..2	Register 3..4	Register 5..6	Register 7..8	Register 9..10	Byte 01..20		

Write

Modbus ID:	Control Fnc:	Control Fnc:	Control Fnc:	Address:	Command:	
1	0x06	16BIT	SIGNED	0	0	
UNICAST	N.A					

2022-03-11-14:56:43

Client trace

Clicking the Client Trace button leads to the page below where trace of Modbus communication can be enabled/disabled. The Modbus Tester only shows the result/content of valid Modbus frames received. The Trace, on the other hand, provides information on any communication being detected on the RS485 line even if it is not perceived as valid Modbus frames.

ENcombi

Trace

Modbus: DISABLED

Trace setup page.
Enabling/disabling trace of various device client activities.
Trace is readable via device Telnet server.

2020-07-26-11:35:57

Trace is available via the built-in Telnet server. Clicking on the Telnet server button on the right hand side leads to the Telnet server setup.

Telnet server

On the page below the telnet server access is set up.



ENcombi

TELNET Server:

User0: telnet_user0

Password0: *****

Telnet: ENABLED

ADMIN



Telnet server setup page.
Credential is for device telnet server access.
Telnet is usable for tracing various device client activities.

2020-07-10-13:14:30

Use the PC application "Chiptool" to connect to the Telnet Server to follow activities such as the Modbus trace.

Boot

First page to be displayed after an initial welcome page when switching to the Boot application is the front page of ECweb.

ENcombi



Select your category



2021-02-02-13:42:34

Navigating around in the Service Tool is done in the same manner as in the ECpv2 application.

In the lower center one menu tile is available:

1. "Identifiers" gives access to overview of SW version as well as to the menus for updating SW and switching between the applications.

In the following chapters the content of the menu tile is discussed in detail.

Identifiers

Under this tile, an overview of SW version installed and extras present in the ECpv2 as well as the menu for switching between the applications is found.

ENcombi

Company:

Name:	Website:	Contact:	Support:	Cloud service:
ENcombi	www.encombi.com	sales@encombi.com	support@encombi.com	www.encombi.online



Product:

Type:	Extras:	Project version:	Serial number:
ECpv Boot	-C-H-L-	1.00.0	201901030001

Platform:

Device type:	Device variant:	Chip type:	Rtos:	Version:
WP240	COM	SC24L	V2.06 FULL	V23.9.62.2

Identifiers:

Serial number 1:	Serial number 2:	MAC address:
DF7BC72FA82129E4	5E8BF28E33F0FABB	0030569108A2

2021-02-02-13:43:01

On the right hand side there is one submenu for.

1. SW update.
2. Application switch.

SW update

Clicking the SW update button leads to the page below. From here the ECpv2 and the ECpv2 Service Tool SW can be updated from a USB stick.

ENcombi



Device project update via USB.

- 1: Create an empty folder on your laptop named ECpv2_SW.
- 2: Download the SW file from the website.
- 3: Unzip the downloaded file.
- 4: Navigate to the SW version folder.
- 5: Copy the content of the SW version folder.
- 6: Paste the content to the ECpv2_SW folder.
- 7: Copy the ECpv2_SW folder to the root of a USB stick.
- 8: Insert USB stick into the device.
- 9: Click the search for SW button.
- 10: Wait for the process to complete.
- 11: If completed successfully then revert to the ECPV2 application.



2022-06-28-09:32:06

Download the SW from the website and place it in a folder named "ECpv2_SW" in the root of a USB stick like shown below:

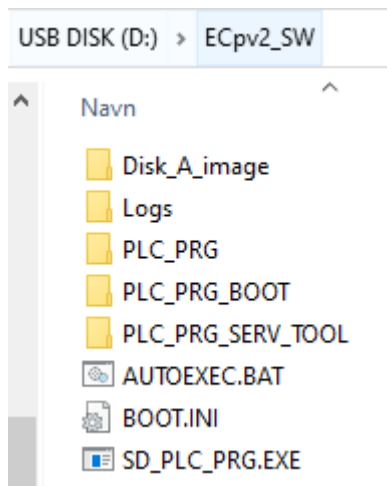

Then insert the USB stick into the ECpv2 and press the binoculars button to start the SW update. When SW update is completed successfully, then you can safely revert to the ECpv2 application. If the SW is interrupted and it fails, then remain in the Boot application and try to update the SW once again. Do not return to the ECpv2 application until SW update is completed successfully.

Application

Clicking the Application button leads to the page below. Here it can be selected which application is to be active.

ENcombi

Application

Application: ECPV2 BOOT



Application swap page.
 Here it is set up which application to run.
 When toggling between applications, the device is to be reboot. Any settings made in the ECpv2 application will be lost in the process. Store a backup before leaving the ECpv2 project if any settings are made that is to be restored when reverting to the ECpv2 application. Browser needs refreshing when the device has rebooted.

2022-06-28-09:31:37

The following applications are available.

1. ECpv2.
2. ECpv2 Service Tool.
3. ECpv2 Boot.

ECpv2 is the default application and the one to use for the normal operation of the ECpv2. ECpv2 Service Tool is a separate application that offers various tests and configurations features and the ECpv2 Boot is a tool for updating both the ECpv2 and the ECpv2 Service Tool SW.

When toggling between applications the device is to be rebooted. Any settings made in the ECpv2 application will be lost in the process. Make a backup before leaving the ECpv2 application if any settings are made that are to be restored when reverting to the ECpv2 application once again. The browser needs refreshing when the device is rebooted after switching the application.